

Merlin Gerin Multi 9 System Protection Miniature Circuit Breakers



Merlin Gerin

Modicon

Square D

Telemecanique

Schneider
 **Electric**

Get more with the world's Power & Control specialist

Protection

Merlin Gerin Multi 9 System
 Miniature circuit breakers
 Tripping curves
 Markings & limitation capability

Trip Unit Variations

Circuit Breaker Marking

Circuit Protection

A choice of several curves
 Whatever circuit has to be protected, a C60 or C120 circuit breaker provides the perfect solution with a suitable curve.

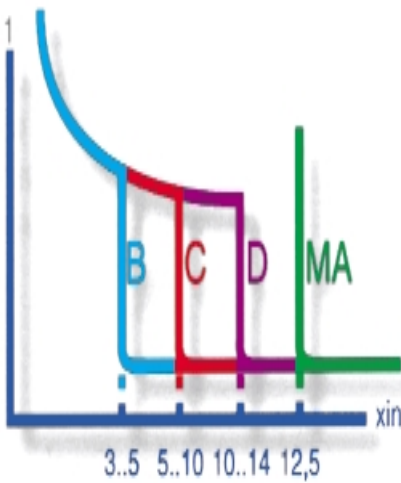

Curve B
 tripping:
 3 to 5 times the rated current (I_n);
 protection of generators, persons, very long cables.



Curve C
 tripping:
 5 to 10 I_n ;
 protection of circuits, general applications.



Curve D
 tripping:
 10 to 14 I_n ;
 protection of high surge circuits, welders, transformers, motors.



Curve MA
 (magnetic only)
 tripping: 12 I_n ;
 protection of motor starters (+ thermal protection when combined with contactor).

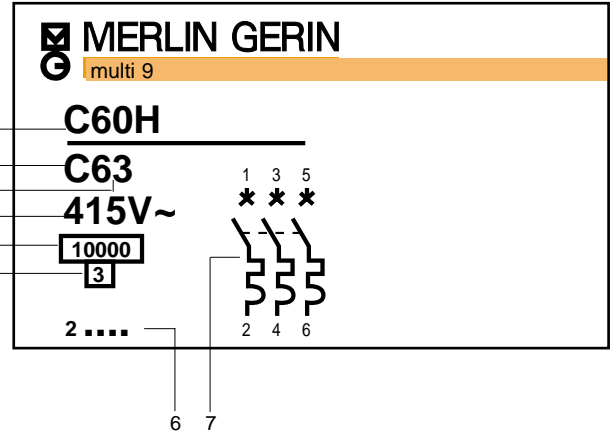

1. Circuit Breaker Model Number
2. Tripping Curve
3. Circuit Breaker Current Rating
4. Operating Voltage
5. Rated Breaking Capacity
6. Circuit Breaker Part Number
7. Electrical Diagram - No. of Poles
8. I_t classification

Circuit Breaker Limitation Capability

The limitation capability of a circuit breaker is that characteristic whereby only a current less than the prospective fault current is allowed to flow under short-circuit conditions.

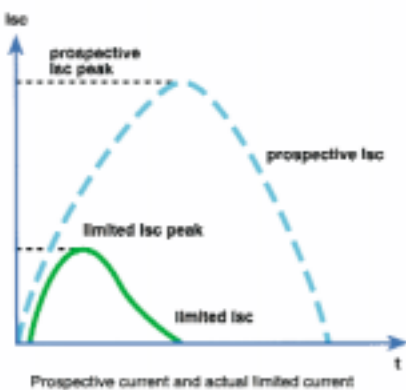

This is illustrated by limitation curves which give:

- The limited peak current in relation to the RMS value of the prospective short-circuit current (the short-circuit current being that current which would flow continuously in the absence of protection equipment).
- The limited current stress in relation to the RMS value of the prospective short-circuit current.
- Current limiting capability. The advanced design of the Multi-9 range provides current limitation with far better protection than conventional circuit breakers. For example, on a 6A rating with a prospective short circuit of 5000A, the current will be limited at 350A or 7%.

Installation of current limiting circuit breakers offers several advantages:

- **Better network protection**
 Current limiting circuit breakers considerably reduce the undesirable effects of short-circuit currents in an installation.
- **Reduced thermal effects**
 Cable heating is reduced, hence longer cable life.
- **Reduced mechanical effects**
 Electrodynamical forces reduced, thus electrical contacts are less likely to be deformed or broken.
- **Reduced electromagnetic effects**
 Measuring equipment situated near an electrical circuit less affected.

Miniature Circuit Breakers – up to 63A

Page

18mm pole width



C60a – 4.5kA	2
C60N – 6kA	3
C60H – 10kA	4
C32H-DC – 10kA (circuit breakers for DC applications)	18
electrical auxiliaries – C60	10
accessories – C60	16

Miniature Circuit Breakers – up to 125A

27mm pole width



C120N – 10kA	6
C120H – 15kA	8
electrical auxiliaries – C120	10
accessories – C120	16

Tm Motor Mechanism

TM C60/C120	21
-------------	----



Dimensions

23

For supplementary technical information, consult AUS010306



protection

circuit-breakers up to 63 A

C60a circuit-breakers

4.5 kA, C curve

AS/NZS 4898



Approval No: N13634

functions

The circuit-breakers combine the following functions:

- protection of circuits against short-circuit currents,
- protection of circuits against overload currents,
- control,
- isolation,

- protection of persons against indirect contact.

- C60a circuit-breakers are used in the domestic sectors where single phase fault levels are less than or equal to 4.5kA.

description

technical data C60a circuit-breakers

- power circuit
 - voltage rating: 240 V AC
 - number of cycles (O-C): 10 000
 - foolproof terminal design
 - moving barrier prevents incorrect cable insertion
 - cable strand centering guides ensure correct cable positions and strand grouping
 - isolation with positive contact indication
 - bistable din clip, simplifies disassembly
- environment
 - tropicalisation: treatment 2 (relative humidity: 95 % at 55 °C)
 - connection: tunnel terminals for the following cables:
 - up to 25A : 25mm² stranded
 - 32 to 63A : 35mm² stranded

C curve

utilisation
cables feeding conventional loads.

technical data

- power circuit
 - tripping curves: the magnetic trip unit operates between 5 and 10 I_n
 - breaking capacity
 - according to AS/NZS 4898 Icu ultimate breaking capacity (0-C0 cycle):

rating (A)	voltage (V)	breaking capacity Icu (A)
1...63	240	4500

catalogue numbers



11357

type	rating (A)	catalogue number	width in mod. of 9 mm	quantity per box
C curve C60a				
1P 	6	11354	2	12
	10	11355	2	12
	16	11356	2	12
	20	11357	2	12
	25	11339	2	12
	32	11358	2	12
	40	11359	2	12
	50	11360	2	12
	63	11361	2	12

protection

circuit-breakers up to 63 A

C60N circuit-breakers

6kA, C curve
AS/NZS 4898



Approval No: N13634

functions

The circuit-breakers combine the following functions:

- protection of circuits against short-circuit currents,
- protection of circuits against overload currents,
- control,

- isolation,
- protection of persons against indirect contact.

description

technical data common to C60N circuit breakers

- power circuit
 - voltage rating: 240/415 V AC
 - for 2P single phase 240/480V
 - I²t classification: 3
 - number of cycles (O-C): 20 000
 - foolproof terminal design
 - moving barrier prevents incorrect cable insertion
 - cable strand centering guides ensure correct cable positions and strand grouping
 - isolation with positive contact indication
 - bistable din clip, simplifies disassembly
- environment
 - tropicalisation: treatment 2 (relative humidity: 95 % at 55 °C)
 - connection: tunnel terminals for the following cables:
 - up to 25A : 16mm² flexible with cable end : 25mm² stranded
 - 32 to 63A : 25mm² flexible with cable end : 35mm² stranded

C curve

utilisation
cables feeding conventional loads.

technical data

- power circuit
 - tripping curves: the magnetic trip units operate between 5 and 10 I_n
 - breaking capacity according to AS/NZS 4898, I_{cu} ultimate breaking capacity (O-CO cycle):

rating (A)	type	voltage (V)	breaking capacity I _{cu} (A)
1...63	1P	240/415	6 000
	2P	415...480	6 000
	3P	415	6 000

catalogue numbers



25804

type	rating (A)	catalogue number
------	------------	------------------

C curve C60N

1P



Width in mod of 9mm - 2

1	25797
2	25798
4	25800
6	25801
10	25802
16	25803
20	25804
25	25805
32	25806
40	25807
50	25808
63	25809

2P



Width in mod of 9mm - 4

1	25811
2	25812
4	25814
6	25815
10	25816
16	25817
20	25818
25	25819
32	25820
40	25821
50	25822
63	25823

25818



25832

3P

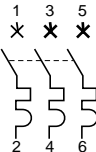

Width in mod of 9mm - 6

1	25825
2	25826
4	25828
6	25829
10	25830
16	25831
20	25832
25	25833
32	25834
40	25835
50	25836
63	25837

protection

circuit-breakers up to 63 A

C60H circuit-breakers

10kA, B, C and D curves

AS/NZS 4898



Approval No: N13634

functions

The circuit-breakers combine the following functions:

- protection of circuits against short-circuit currents,
- protection of circuits against overload currents,
- control,

- isolation,
- protection of persons against indirect contact.

description

technical data common to C60H circuit-breakers

- power circuit
- voltage rating: 240/415 V AC
- breaking capacity
 - according to AS/NZS 4898,
 - lcv ultimate breaking capacity (O-CO cycle):

rating (A)	type	voltage (V)	break. cap. lcu (A)
1...63	1P, 2P	240/415	10 000
	3P, 4P	415...480	10 000

- I²t classification: 3
- foolproof terminal design
 - moving barrier prevents incorrect cable insertion
 - cable strand centering guides ensure correct cable positions and strand grouping
- isolation with positive contact indication
- bistable din clip, simplifies disassembly
- isolation with positive contact indication: opening is indicated by a green strip on the device operating handle. This indicator shows opening of all the poles
- number of cycles (O-C): 20 000

- environment
- tropicalisation: treatment 2 (relative humidity: 95 % at 55 °C)
- connection: tunnel terminals for the following cables:
 - up to 25A :16mm² flexible with cable end; 25mm² stranded
 - 32 to 63A :25mm² flexible with cable end; 35mm² stranded

B curve

utilisation

when there are small inrush currents (generators, long cables).

technical data

- power circuit
- tripping curve: the magnetic trip units operate between 3 and 5 In.

C curve

utilisation

cables feeding conventional loads.

technical data

- power circuit
- tripping curve: the magnetic trip units operate between 5 and 10 In.

D curve

utilisation

loads with a high inrush current (motors, transformers).

technical data

- power circuit
- tripping curve: the magnetic trip units operate between 10 and 14 In.

C60H circuit-breakers

10kA, B, C and D curve
AS/NZS 4898



Approval No: N13634

catalogue numbers



25845







25857



25871



25883

type	rating (A)	B Curve	C Curve	D Curve
C60H				
1P 	1	<u>25839</u>	<u>25639</u>	<u>25695</u>
	2	<u>25840</u>	<u>25640</u>	<u>25696</u>
	4	<u>25841</u>	<u>25642</u>	<u>25698</u>
	6	<u>25842</u>	<u>25643</u>	<u>25699</u>
	10	<u>25843</u>	<u>25644</u>	<u>25700</u>
	16	<u>25844</u>	<u>25645</u>	<u>25701</u>
	20	<u>25845</u>	<u>25646</u>	<u>25702</u>
	25	<u>25846</u>	<u>25647</u>	<u>25703</u>
	32	<u>25847</u>	<u>25648</u>	<u>25704</u>
	40	<u>25848</u>	<u>25649</u>	<u>25705</u>
	50	<u>25849</u>	<u>25651</u>	<u>25707</u>
	63	<u>25850</u>	<u>25652</u>	<u>25708</u>
	2P 	1	<u>25852</u>	<u>25653</u>
2		<u>25853</u>	<u>25654</u>	<u>25710</u>
4		<u>25854</u>	<u>25656</u>	<u>25712</u>
6		<u>25855</u>	<u>25656</u>	<u>25713</u>
10		<u>25856</u>	<u>25658</u>	<u>25714</u>
16		<u>25857</u>	<u>25659</u>	<u>25715</u>
20		<u>25858</u>	<u>25660</u>	<u>25716</u>
25		<u>25859</u>	<u>25661</u>	<u>25717</u>
32		<u>25860</u>	<u>25662</u>	<u>25718</u>
40		<u>25861</u>	<u>25663</u>	<u>25719</u>
50		<u>25862</u>	<u>25665</u>	<u>25721</u>
63		<u>25863</u>	<u>25666</u>	<u>25722</u>
3P 		1	<u>25865</u>	<u>25667</u>
	2	<u>25866</u>	<u>25668</u>	<u>25724</u>
	4	<u>25867</u>	<u>25670</u>	<u>25726</u>
	6	<u>25868</u>	<u>25671</u>	<u>25727</u>
	10	<u>25869</u>	<u>25672</u>	<u>25728</u>
	16	<u>25870</u>	<u>25673</u>	<u>25729</u>
	20	<u>25871</u>	<u>25674</u>	<u>25730</u>
	25	<u>25872</u>	<u>25675</u>	<u>25731</u>
	32	<u>25873</u>	<u>25676</u>	<u>25732</u>
	40	<u>25874</u>	<u>25677</u>	<u>25733</u>
	50	<u>25875</u>	<u>25679</u>	<u>25735</u>
	63	<u>25876</u>	<u>25680</u>	<u>25736</u>
	4P 	1	<u>25878</u>	<u>25007</u>
2		<u>25879</u>	<u>25008</u>	<u>25212</u>
4		<u>25880</u>	<u>25010</u>	<u>25214</u>
6		<u>25881</u>	<u>25011</u>	<u>25215</u>
10		<u>25882</u>	<u>25012</u>	<u>25216</u>
16		<u>25883</u>	<u>25013</u>	<u>25217</u>
20		<u>25884</u>	<u>25014</u>	<u>25218</u>
25		<u>25885</u>	<u>25015</u>	<u>25219</u>
32		<u>25886</u>	<u>25016</u>	<u>25220</u>
40		<u>25887</u>	<u>25017</u>	<u>25221</u>
50		<u>25888</u>	<u>25018</u>	<u>25222</u>
63		<u>25889</u>	<u>25019</u>	<u>25223</u>

protection

circuit breakers up to 125A

C120N circuit-breakers

10kA, B, C curves - AS/NZS 4898

10kA, D curve AS 3947-2

function

The circuit-breakers combine the following functions:

- protection of circuits against short circuit currents,
- protection of circuits against overload currents,
- control,

- isolation,
- protection of persons against indirect contact.

description

Technical data common to C120N circuit breakers

- power circuit
- current rating: 63 to 125 A
- voltage rating 415 V AC
- insulation voltage U_i : 500 V
- impulse withstand voltage U_{imp} : 6 kV
- breaking capacity:
 - according to AS/NZS 4898 I_{cu} ultimate breaking capacity (O-CO cycle)

type	voltage (V)	breaking cap. I _{cu} (A)
1, 2, 3, 4P	240/415	10000

- according to AS3947-2 I_{cu} ultimate breaking capacity (O-CO cycle)

type	voltage (V)	breaking cap. I _{cu} (kA)
1P	240	10
	415	3
2, 3, 4P	400...415	10

- mechanical durability:
 - 20000 cycles (O-C)
- electrical durability:
 - 63 A: 10000 cycles (O-C)
 - 80...125 A: 5000 cycles (O-C)
- I²t classification: 3
- isolation with positive contact indication: opening is indicated by a green strip on the device operating handle. This indicator shows opening of all the poles
- foolproof terminal design
 - moving barrier prevents incorrect cable insertion
 - cable strand centering guides ensure correct cable positions and strand grouping
- bistable din clip: simplifies disassembly
- 63 to 125A:
 - up to 35mm² flexible with cable end
 - up to 50mm² stranded

B curve



Approval No:Q00542

utilisation

when there are small inrush currents (generators, long cables).

technical data

- power circuit
- tripping curve: the magnetic trip units operate between 3 and 5 I_n.

C curve



Approval No:Q00542

utilisation

cables feeding conventional loads.

technical data

- power circuit
- tripping curve: the magnetic trip units operate between 5 and 10 I_n.

D curve - For industrial use only

utilisation

loads with a high inrush current (motors, transformers).

technical data







- power circuit
- tripping curve: the magnetic trip units operate between 10 and 14 I_n.

C120N circuit-breakers

10kA, B, C curves - AS/NZS 4898

10kA, D curve AS 3947-2

catalogue numbers

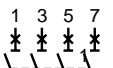
type	rating (A)	B Curve	C Curve	D Curve
B curve C120N				
 <p>1P</p> <p>1</p>  <p>2</p>	63	18340	18356	18378
	80	18341	18357	18379
	100	18342	18358	18380
	125	18343	18359	18381
	Width in mod of 9mm - 3			
 <p>2P</p> <p>1 3</p>  <p>2 4</p>	63	18344	18360	18382
	80	18345	18361	18383
	100	18346	18362	18384
	125	18347	18363	18385
	Width in mod of 9mm - 6			
 <p>3P</p> <p>1 3 5</p>  <p>2 4 6</p>	63	18348	18364	18386
	80	18349	18365	18387
	100	18350	18367	18388
	125	18351	18369	18389
	Width in mod of 9mm - 9			
 <p>4P</p> <p>1 3 5 7</p>  <p>2 4 6 8</p>	63	18352	18371	18390
	80	18353	18372	18391
	100	18354	18374	18392
	25	18355	18377	18393
	Width in mod of 9mm - 12			

protection

circuit breakers up to 125A

C120H circuit-breakers

15kA, B, C curves - AS/NZS 4898

15kA, D curve AS 3947-2

function

The circuit-breakers combine the following functions:

- protection of circuits against short circuit currents,
- protection of circuits against overload currents,
- control,

- isolation,
- protection of persons against indirect contact.

description

Technical data common to C120N circuit breakers

- power circuit
- current rating: 10 to 125 A
- voltage rating 415 V AC
- insulation voltage U_i : 500 V
- impulse withstand voltage U_{imp} : 6 kV
- breaking capacity:
 - according to AS/NZS 4898 Icu ultimate breaking capacity (O-CO cycle)

type	voltage (V)	breaking cap. Icu (A)
1, 2, 3, 4P	240/415	15000

- according to AS3947-2 Icu ultimate breaking capacity (O-CO cycle)

type	voltage (V)	breaking cap. Icu (kA)
1P	240	15
	415	4.5
2, 3, 4P	400...415	15

- mechanical durability:
 - 20000 cycles (O-C)
- electrical durability:
 - 63 A: 10000 cycles (O-C)
 - 80...125 A: 5000 cycles (O-C)
- I^2t classification: 3
- isolation with positive contact indication: opening is indicated by a green strip on the device operating handle. This indicator shows opening of all the poles
- foolproof terminal design
 - moving barrier prevents incorrect cable insertion
 - cable strand centering guides ensure correct cable positions and strand grouping
- bistable din clip: simplifies disassembly
- 63 to 125A:
 - up to 35mm² flexible with cable end
 - up to 50mm² stranded

B curve



Approval No:Q00542

utilisation

when there are small inrush currents (generators, long cables).

technical data

- power circuit
- tripping curve: the magnetic trip units operate between 3 and 5 I_n.

C curve



Approval No:Q00542

utilisation

cables feeding conventional loads.

technical data

- power circuit
- tripping curve: the magnetic trip units operate between 5 and 10 I_n.

D curve - For industrial use only

utilisation

loads with a high inrush current (motors, transformers).

technical data

- power circuit
- tripping curve: the magnetic trip units operate between 10 and 14 I_n.

protection

circuit-breakers up to 125 A

C120H circuit-breakers

15kA, B, C curves - AS/NZS 4898

15kA, D curve AS 3947-2

catalogue numbers



18394



18412



18424



18437

type	rating (A)	B Curve	C Curve	D Curve	
C120H					
1P 1 * 2	10	18394	18438	18482	
	16	18395	18439	18483	
	20	18396	18440	18484	
	25	18397	18441	18485	
	32	18398	18442	18486	
	40	18399	18443	18487	
	50	18400	18444	18488	
	63	18401	18445	18489	
	80	18402	18446	18490	
	100	18403	18447	18491	
	125	18404	18448	18492	
	Width in mod of 9mm - 3				
	2P 1 3 * * 2 4	10	18405	18449	18493
16		18406	18449	18494	
20		18407	18451	18495	
25		18408	18452	18496	
32		18409	18453	18497	
40		18410	18454	18498	
50		18411	18455	18499	
63		18412	18456	18500	
80		18413	18457	18501	
100		18414	18458	18502	
125		18415	18459	18503	
Width in mod of 9mm - 6					
3P 1 3 5 * * * 2 4 6		10	18416	18460	18504
	16	18417	18461	18505	
	20	18418	18462	18506	
	25	18419	18463	18507	
	32	18420	18464	18508	
	40	18421	18465	18509	
	50	18422	18466	18510	
	63	18423	18466	18511	
	80	18424	18468	18512	
	100	18425	18469	18513	
	125	18426	18470	18514	
	Width in mod of 9mm - 9				
	4P 1 3 5 7 * * * * 2 4 6 8	10	18427	18471	18515
16		18428	18472	18516	
20		18429	18473	18517	
25		18430	18474	18518	
32		18431	18475	18519	
40		18432	18476	18520	
50		18433	18477	18521	
63		18434	18478	18522	
80		18435	18479	18523	
100		18436	18480	18524	
125		18437	18481	18525	
Width in mod of 9mm - 12					

electrical auxiliaries for C60 and C120 circuit-breakers

function

They allow remote tripping or indication of circuit-breakers, with or without a Vigi module.

description

- they are mounted on the left-hand side of the circuit-breaker within a width limit of 54 mm
- fixed using clips (without tools) on the left-hand side of the circuit-breaker
- compatible with Vigi modules (adaptable on the right-hand side)
- a maximum of 3 indication auxiliaries on the same circuit-breaker
- a maximum of 2 OF+SD/OF auxiliary switches on the same circuit-breaker
- a maximum of 2 MX+OF or MN tripping auxiliaries on the same circuit-breaker
- a maximum of 1 MN[Ⓢ] or MNx or MSU tripping auxiliary on the same circuit-breaker.

auxiliary combination

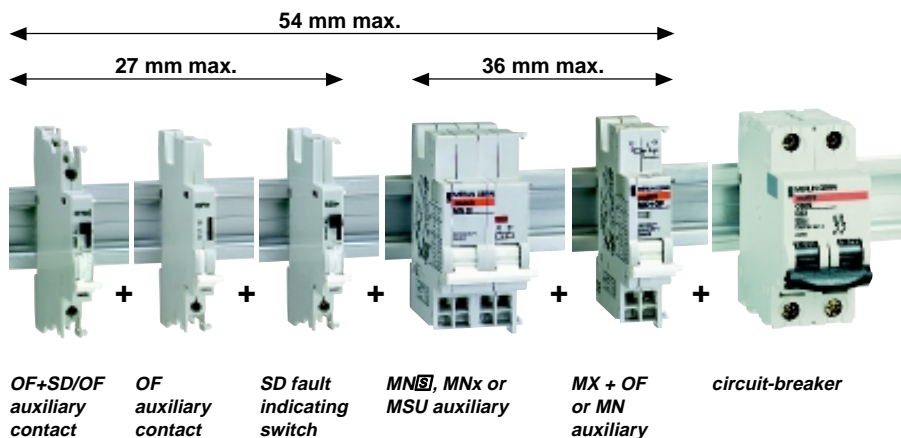

electrical auxiliaries for C60 and C120 circuit-breakers

tripping

Visualisation of tripping by means of the red indicator on front face.

MX + OF shunt trip

Remote tripping of a circuit-breaker:

- equipped with an OF changeover switch:
 - to indicate the circuit-breaker's position
 - to carry out self-breaking allowing the control circuit to remain energized.

Undervoltage releases (MN, MN)

Controls the tripping of a circuit-breaker when its supply voltage drops (threshold between 70 and 35 % of Un)

It allows for manual closing of the circuit-breaker if its voltage exceeds 85 % of the rated voltage

delayed MN release

0.2 second time-delay: prevents tripping due to brownouts or momentary voltage decreases.

MNx release for opening pushbutton

Completely unaffected by power supply circuit cuts, it is recommended for fail-safe emergency stopping. Replaces the MX "voluntary" release equipped with its NO/NC indicator lights.

MSU overvoltage

MSU voltage threshold release

Specially designed to monitor voltage between the neutral and phase(s) conductors, it cuts power supply by opening the circuit-breaker in event of an overvoltage. For overvoltages lasting for more than a few seconds.

technical data

Compliance with standard: AS 3947-2

□ release consumption

type	voltage (V AC or DC)			power (W or VA)
MX+OF	415 V	AC	inrush	120
		220...240 V	AC	inrush
	110...130 V	AC	inrush	200
		DC	inrush	10
	48 V	AC	inrush	22
		DC	inrush	12
	24 V	AC	inrush	120
		DC	inrush	120
12 V	AC	inrush	20	
	DC	inrush	20	
MN	220...240 V	AC	holding	4.1
		DC	holding	4.3
	48 V	DC	holding	2.0
MN 	220...240 V	AC	holding	4.1
MNx	230	AC	inrush	50
	400	AC	inrush	120
MSU	230	AC	inrush	50
	400	AC	inrush	120

remote indication

OF auxiliary switch

- changeover switch that indicates the "open" or "closed" position of the circuit-breaker.
- test button on the front face that allows for the indication circuit to be verified without operating the circuit-breaker

SD fault indicating switch

- changeover switch that indicates the "fault trip" position of the circuit-breaker
- visualisation of the fault (SD) by means of a mechanical indicator on front face.

OF+SD/OF selector switch

- double changeover switch that indicates:
 - the "open" or "closed" position of the circuit-breaker (OF)
 - the "fault trip" position of the circuit-breaker (SD).
- 2 circuits:
 - upper: OF
 - lower: SD or OF.
- function is selected using rotary selector switch on the right-hand side
- the selected function is indicated on the front face
- visualisation of the fault (SD) by means of a red mechanical indicator on front face.

technical data

Complies with standard: AS 3947-2

□ rated current of auxiliary contacts

voltage (V AC or DC)	rated current (A)	
415 V	AC	3
≤ 240 V	AC	6
130 V	DC	1
≤ 48 V	DC	2
≤ 24 V	DC	6

connection

- using screw clamp terminals for 1 or 2 cables (max. 2.5 mm²)
- visible markers near terminals.

electrical auxiliaries for C60 and C120 circuit-breakers

references



26946

type

control voltage (V AC)	(V DC)	catalogue number	width in mod. of 9 mm
---------------------------	--------	---------------------	-----------------------------

MX + OF shunt release

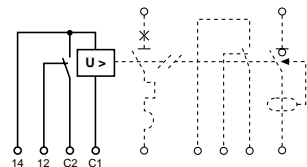

220...415	110...130	26946	2
48...130	48	26947	2
24	24	26948	2
12	12	26949	2



26979

MSU overvoltage release

1P + N

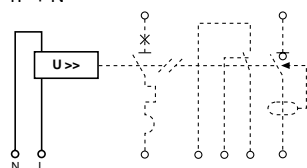

220...240	26979	4
-----------	--------------	---

3P + N

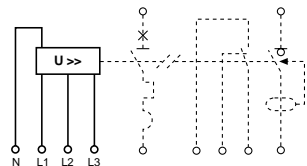

380...415	26980	4
-----------	--------------	---



26963

MN undervoltage release

instantaneous

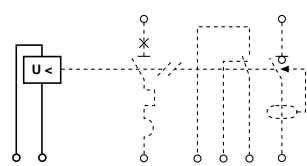

220...240	26960	2
48	26961	2
48	26962	2

delayed

220...240	26963	4
-----------	--------------	---



26969

MNx release for opening pushbutton

Ph + N

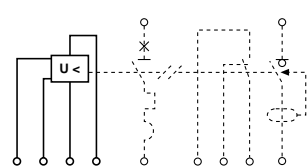

220...240	26969	4
-----------	--------------	---

Ph to Ph

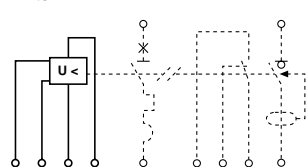

380...415	26971	4
-----------	--------------	---

electrical auxiliaries for C60 and C120 circuit-breakers



26927

type

control voltage
(V AC) (V DC)

catalogue
number

width
in mod.
of 9 mm

SD fault indicating switch

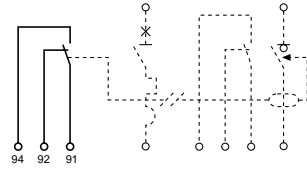

26927

1



26924

OF auxiliary contact

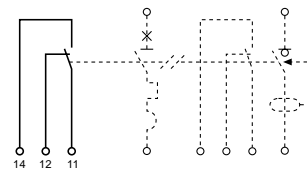

26924

1



26929

OF+SD/OF selector switch

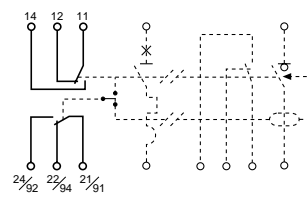

26929

1

OF contact and SD switch, MX+OF, MN and MN^S releases for C60 and C120 circuit-breakers

shunt release MX + OF

application

- remote opening by circuit-breaker tripping, of electrical lighting circuits, etc
- terminals 12 and 14 are used for indication of the circuit-breaker OF position, at a voltage identical to coil voltage
- indication on the front face of the tripped function, by a red mechanical indicator.

connection

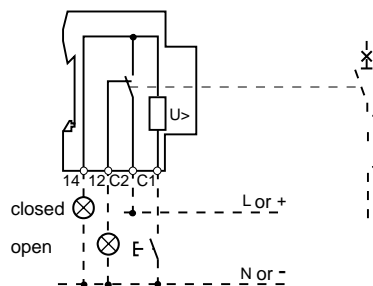

undervoltage release MN or MN^S

application

- opening of electrical circuits by circuit-breaker tripping:
 - either by emergency stopping (mushroom head pushbutton)
 - or on mains failure
- impossibility of uncontrolled restart is particularly recommended in two cases, thus guaranteeing complete safety:
 - when the machine operator is confronted with a risk of untimely restart: circular saw, rotating machine, etc
 - when it is necessary to control restart of an installation further to a mains failure
- indication on the front face of the tripped function, by a red mechanical indicator
- the MN coil is accepted as an emergency stopping device by the installation standard. However it does not indicate the OFF position of a circuit-breaker.

connection

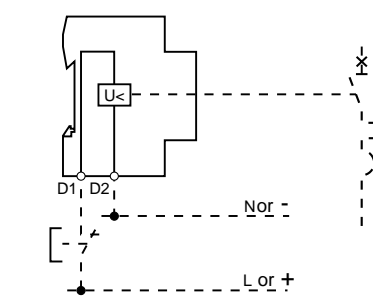

MNx release for emergency stopping on opening

application

- remote opening of the circuit by circuit-breaker tripping on a voluntary order:
 - emergency stop pushbutton on opening (fail-safe)
 - completely unaffected by network fluctuations.

connection

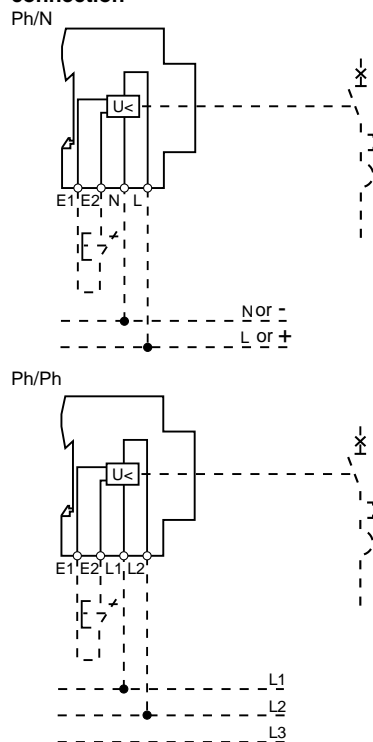

OF contact and SD switch, MX+OF, MN and MN^S releases for C60 and C120 circuit-breakers

OF auxiliary contact

application

- audible or visual indication of circuit-breaker "open" or "closed" contact status
- this indication can be transferred to the front face of a cubicle or enclosure or centralised on a control desk
- optional contact testing using the knob on the front face, with the circuit-breaker open.

circuit-breaker	OF contact position
open	11-12
closed	11-14
tripped	11-12

connection

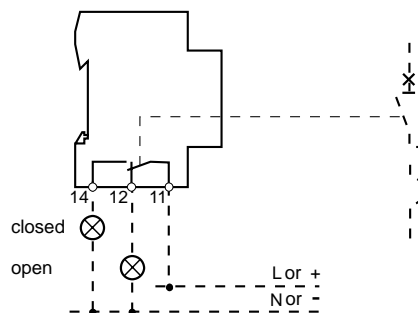

SD fault indicating switch

application

- audible or visual indication of circuit-breaker tripped status: climatic room, lift, ventilation, etc
- front face indication of contact status (red mechanical indicator) and of the "fault clearance" function
- optional resetting of indication separately from the circuit-breaker
- optional testing of contact on front face, with the circuit-breaker open.

circuit-breaker	OF contact position
open	91-94
closed	91-94
tripped	91-92

connection

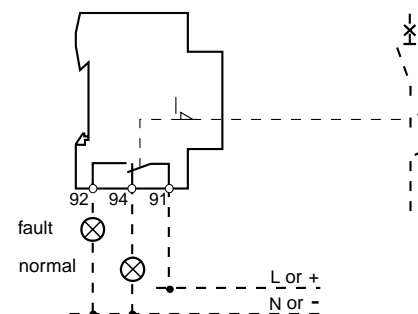

OF + SD/OF changeover auxiliary switch

application

- double changeover switch:
 - the top switch indicates the "open" or "closed" status of the circuit-breaker
 - the bottom switch indicates according to user choice:
 - the "open" or "closed" status (OF)
 - the "tripped" status (SD)
- front face indication of the tripped status, by red mechanical indicator (regardless of lateral selector switch position)
- optional testing of the bottom switch (SD changeover) on the front face, with the circuit-breaker open
- optional resetting of indication separately from the circuit-breaker.

circuit-breaker	OF contact position
open	11-12 21-22
closed	11-14 21-24
tripped	11-12 21-22

circuit-breaker	SD switch position
open	91-94
closed	91-94
tripped	91-92

connection

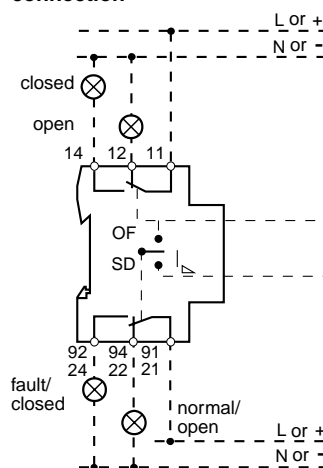

Vigi modules for C60 and C120 circuit-breakers

function

Common function

Adaptable to C60 & C120 circuit-breakers to 125 A - 2, 3, 4P, the Vigi up module ensures:

- the protection of electrical installations against insulation faults
 - the protection of persons against indirect contact: medium sensitivities (300, 500mA)
 - additional protection of persons against direct contact: high sensitivity (30 mA)
- The C60/C120 residual current device complies

with standard EN 61009: no heat derating of the circuit-breaker

It is equipped with a locating device that ensures the correct rating and number of poles

The technical data of circuit-breakers that are combined with Vigi modules remain unchanged and the circuit-breakers remain compatible with indication or control auxiliaries

AC class

Vigi module for which tripping is ensured by sinusoidal AC currents whether they are quickly applied or rise slowly

Instantaneous

It ensures instantaneous tripping (not time-delayed)

Selective

Selective  Vigi modules allow for total vertical discrimination if:

- upstream devices are s or delayed
- downstream devices are instantaneous and their sensitivity is less than $ID_n/2$ of the upstream device.

description

Technical data

■ the Vigi module incorporates the residual current relay and toroid in a case. Its earth leakage module is electro-mechanical.

It functions without an auxiliary power supply source and thus has a very wide operating range

■ protected against nuisance tripping due to transient overvoltages (lightning stroke, switchgear switching on the network, etc.)

■ breaking and making capacity upon short-circuit is equal to the breaking capacity of the circuit-breaker

■ instantaneous or selective s trip units

■ reinforced electromagnetic compatibility

■ remote tripping:

possible using an MX or MN release on circuit-breaker

■ connection by tunnel terminals in mod. of 9mm

■ fault indication by means of a red strip on the resetting handle

■ resetting the Vigi module, at user's convenience:

□ either using the circuit-breaker handle

□ or independently of the circuit-breaker.

■ AC class: 50/60Hz

■ Minimum operating threshold for test button

□ Vigi C60 : 100VAC

□ Vigi C120 : 176VAC

■ AS3190, AS/NZS61009 (IEC61009)

■ Connection by tunnel terminals

□ Vigi C60 : up to 35mm² stranded cables

□ Vigi C120 : up to 50mm² stranded cables

□ Copper or aluminium cables (using aluminium cable terminal).

type	Vigi C60	Vigi C120
2P	4	7
3P	7	10
4P	7	10

combination of earth leakage modules with circuit-breakers



C120 residual current device

=



C120 circuit breaker

+



Vigi C120 module

Vigi modules for C60 and C120 circuit-breakers

catalogue numbers



type	voltage (V)	sens. (mA)	catalogue number
Vigi C60 type AC (≤63A)			
2P 	240...415	30 mA	26658
		300mA	26660
3P 	415	30 mA	26620
		300mA	26682
4P 	415	30 mA	26665
		300mA	26667



type	voltage (V)	sens. (mA)	catalogue number
Vigi C120 type AC (≤125A)			
2P 	230...415	30	18563
		300	18564
		500	18565
3P 	230...415	30	18566
		300	18567
		500	18568
4P 	230...415	30	18569
		300	18570
		500	18571

accessories

for C60 and C120 circuit-breakers

catalogue numbers



26970



26981



26976







27060

type	suitable for	catalogue number	quantity per box
padlocking facility	C60	26970	2
	C120	27145	4
<hr/>			
	C60 circuit-breaker	26981	2
	Vigi C60	26982	10
	C120 circuit-breaker	18527	2
<hr/>			
terminal shield	C60	1P	26975
		2P	26976
		3P	26975 + 26976
		4P	26978
<hr/>			
terminal shield	C120	1P	18526
		2P	2 x 18526
		3P	3 x 18526
		4P	4 x 18526
<hr/>			
insulated sub-terminal		19091	4
<hr/>			
aluminium cable terminal		27060	1

accessories

for C60 and C120 circuit breakers

	type	catalogue number	quantity per box
	screw connection	<u>27053</u>	8
	rear connection terminal with 1P terminal shield	<u>18528</u>	2
18528			
	inter-pole barrier	<u>27001</u>	10
	spacer	<u>27062</u>	
27062			
	marker strips	<u>27062</u>	
marker strips			
	label holder C120	<u>27150</u>	10
	replacement wire cover C60		
	2P	<u>26483</u>	5
	3P	<u>26484</u>	5
	4P	<u>26485</u>	5

protection

circuit-breakers up to 40A

C32H-DC circuit-breakers

AS3947-2

functions

The C32H-DC circuit-breakers are designed for the protection and control of power circuits used in DC applications (eg; security lighting, automation, telephone systems)

description

technical data common to C32H-DC circuit-breakers

- power circuit
- voltage rating:
single pole: 125V DC
two pole: 250V DC
- current ratings: 1 to 40 A set at 40 °C
- breaking capacity as in AS3947-2,
Icu ultimate breaking capacity
(O-CO operating cycle)

type	rating (A)	voltage (VDC)	breaking capacity Icu (kA)
1P	1 to 40 A	125	10
2P	1 to 40 A	125	20
		250	10

- tripping curve: type C
the magnetic releases operate between 7 and 10 I_n.
- number of operating cycles:
(O-C) 10,000 at L/R ≤ 0.015 sec
- tropicalisation: treatment 2
(relative humidity 95% at 55°C)
- connection: tunnel terminals for the following cables:
 - 16mm² flexible with cable end
 - 25mm² stranded

■ It is imperative to respect the polarity and function of the power supply.

catalogue numbers



20536

type	rating (A)
------	------------

C32H-DC single pole

1
2
3
6
10
16
20
25
32
40

catalogue number	width in mod of 9 mm	quantity per box
------------------	----------------------	------------------

20531	2	12
20532	2	12
20533	2	12
20534	2	12
20535	2	12
20536	2	12
20537	2	12
20538	2	12
20539	2	12
20540	2	12



20550

type	rating (A)
2P	1
	2
	3
	6
	10
	16
	20
	25
	32
	40

20541	4	6
20542	4	6
20543	4	6
20544	4	6
20545	4	6
20546	4	6
20547	4	6
20548	4	6
20549	4	6
20550	4	6

C32H-DC circuit-breakers for DC applications

selecting the circuit-breaker

The selection of a circuit-breaker most suitable for protection of a DC installation, depends mainly on the following criteria:

- the nominal current, which determines the rating of the equipment
- the type of network
- the nominal voltage, which determines the number of poles to be involved in breaking
- the maximum short-circuit current at the point of installation, which determines the breaking capacity

calculation of the short-circuit current (I_{sc}) at the terminal of a battery

When a short-circuit occurs at its terminals, a battery discharges a current given by Ohm's law:

$$I_{sc} = \frac{V_b}{R_i}$$

where V_b = the maximum discharge voltage (battery 100 % charged)
and R_i = the internal resistance equivalent to the sum of the cell resistances (figure generally given by the manufacturer in terms of Ampere-hour capacity of the battery).

example

What is the short-circuit current at the terminals of standing battery with the following characteristics:

- capacity: 500 Ah
- maximum discharge voltage: 240 V (110 cells of 2.2 V)
- discharge current: 300 A
- internal resistance: 0.5 mΩ per cell

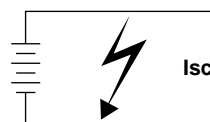

$$R_i = 110 \times 0.5 \times 10^{-3}$$

$$I_{sc} = \frac{240}{55 \times 10^{-3}} = 4.4 \text{ kA}$$

As the above calculation shows, the short-circuit current is relatively weak.

Note: if the internal resistance is not known, the following approximate formula can be used:
 $I_{sc} = kC$, where C is capacity of the battery expressed in Ampere-hours, and k is a coefficient close to 10 but in any case always lower than 20.

C32H-DC circuit-breakers for DC applications

recommendations for use

The C32H-DC special DC circuit-breaker is designed for the control and protection of circuits up to 250 V DC with $I_{sc} \leq 20$ kA. For higher voltages or short-circuit currents, refer to the previous pages.

connection diagram

The circuit-breaker connection diagram to be used depends on the service voltage, the I_{sc} of the installation and the position of the load:

C32H-DC 1 pole

■ service voltage ≤ 125 V DC

■ $I_{sc} \leq 10$ kA

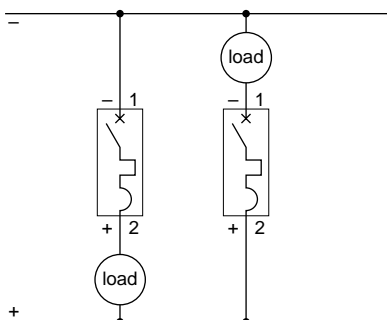

C32H-DC 2 poles

■ service voltage ≤ 125 V DC

■ $I_{sc} \leq 20$ kA

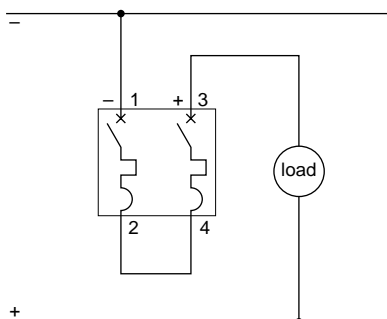

C32H-DC 2 poles

■ service voltage ≤ 250 V DC

■ $I_{sc} \leq 10$ kA

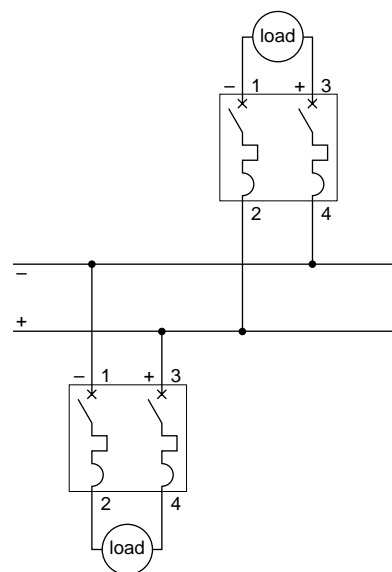

Note :

The C32H-DC is a polarized circuit-breaker, equipped with a permanent magnet for satisfactory breaking of the rated current. In accordance with the diagram to be used, always respect the + and - polarities indicated on the circuit-breaker.

Tm motor mechanism for C60N/H and C120N/H circuit breakers

function

- Tm motor mechanism is used for:
- the remote control of C60/C120 circuit-breakers (with or without a Vigi module) via a latched order,
 - circuit-breaker resetting after tripping.

Local control using the operating handle continues to be possible, as is adaptation of other circuit-breaker auxiliaries.

description

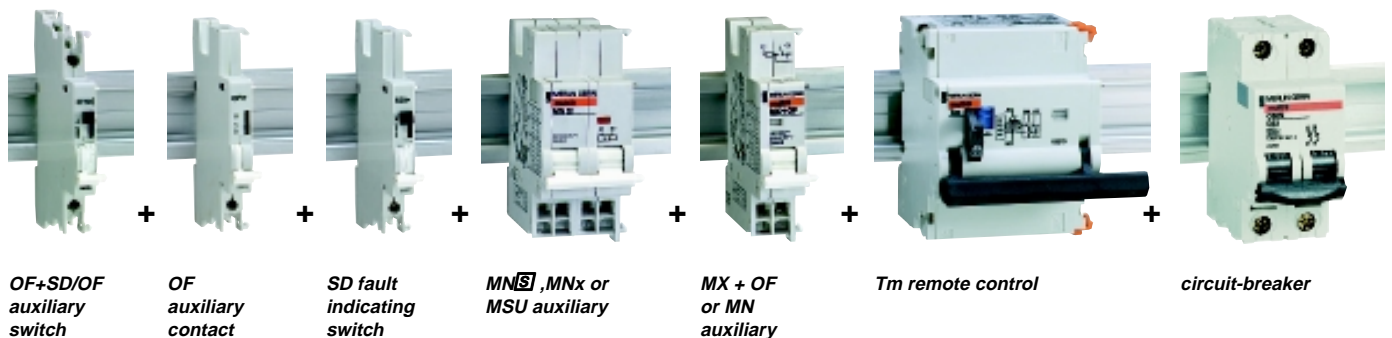

OF+SD/OF
auxiliary
switch

OF
auxiliary
contact

SD fault
indicating
switch

MN, MNx or
MSU auxiliary

MX + OF
or MN
auxiliary

Tm remote control

circuit-breaker

- Tm modules are controlled by an electrical latched type order.

- a disconnection selector switch placed on the front panel is used to:
 - neutralise the remote control
 - lock the remote controlled circuit-breaker in the "open" position (7 mm Ø padlock not supplied).

- a mechanical indicator shows the "open" or "closed" status of the Tm remote control.

- reclosing after a fault:
 - must be carried out in manual mode, locally after search and clearance of the fault
 - to impose manual and local resetting, an SD auxiliary switch (ref. 26927), cabled in series in the Tm module, prevents automatic and remote reclosing
 - remote reclosing is possible provided regulations are complied with: resetting takes place by opening the control circuit for more than 1.5 s.

- auxiliaries in the C60/C120 range, adaptable to circuit-breakers using clips (without tools),
 - instantaneous or delayed undervoltage tripping: MN and MNx
 - instantaneous shunt tripping: MX+OF
 - fault trip indication: SD
 - indication of the circuit-breaker's "open" or "closed" position: OF
 - other possible control modes:
 - control by an impulse and/or latched order: ACTc
 - time-delayed: ACTt
 - by BatiBUS network: ATB1s.

technical data

- control voltage (Uc): 230 V AC (-15 % +10 %)
- frequency: 50...60 Hz
- consumption:
 - inrush:
 - TmC60: 28 VA
 - TmC120: 35 VA
 - holding: 2 VA
- insensitive to brownouts: ≤ 0.45 s
- undervoltage behaviour:
 - > 0.45 s, mechanical opening of poles
 - reclosing 2 s after power is restored.
- number of cycles (O-C) at 40 °C:
 - Tm + C60: 20 000
 - Tm + C120 (≤ 63 A): 10 000
 - Tm + C120 (80...125 A): 5 000.
- opening time by Tm: 0.5 s
- closing time by Tm: 2 s

connection

- using tunnel terminals:
 - 1 x 6 mm² cable
 - 2 x 1.5 mm² or 2.5 mm² cables.

weight

- 1-2P: 300 g
- 3-4P: 310 g.

Tm motor mechanism

for C60N/H and C120N/H circuit breakers

catalogue numbers

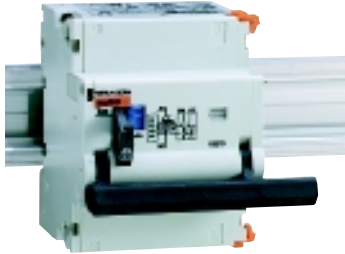

18310

type	voltage (v AC)
C60 1-2P C120 1-2P	230

catalogue number	width in mod. of 9 mm	quantity per box
18310	7	
18312	7	

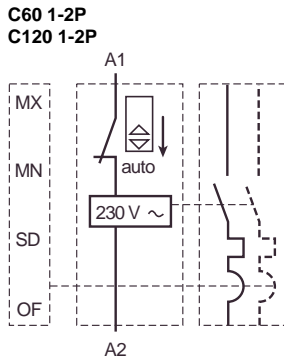

18310	7	
18312	7	

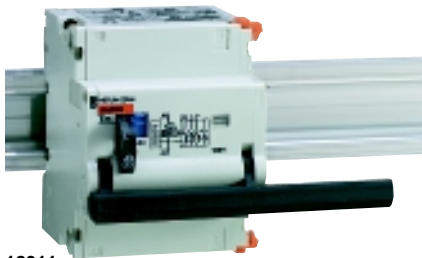

18311

type	voltage (v AC)
C60 3-4P C120 3-4P	230

catalogue number	width in mod. of 9 mm	quantity per box
18311	7	
18313	7	

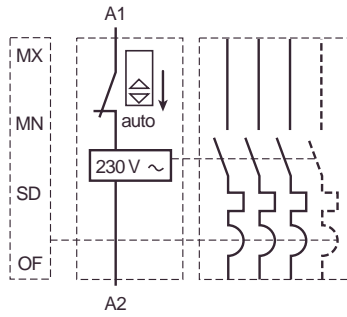

Dimensions

C60a/N/H circuit breakers

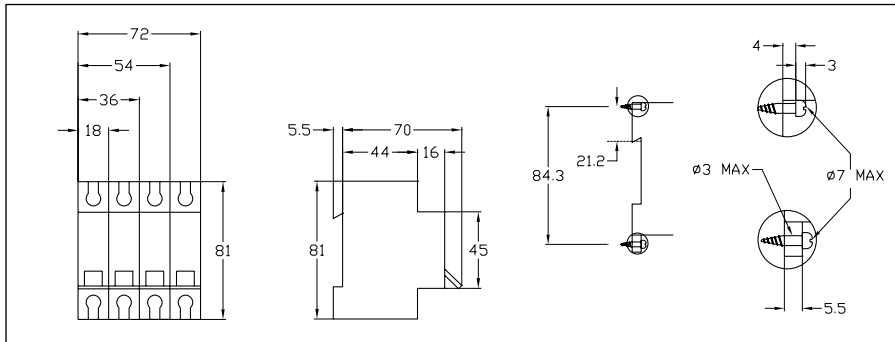

Vigi C60

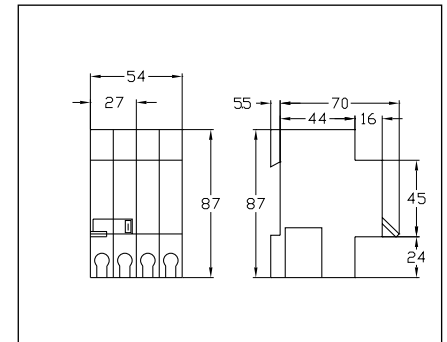

C120N/H circuit breakers

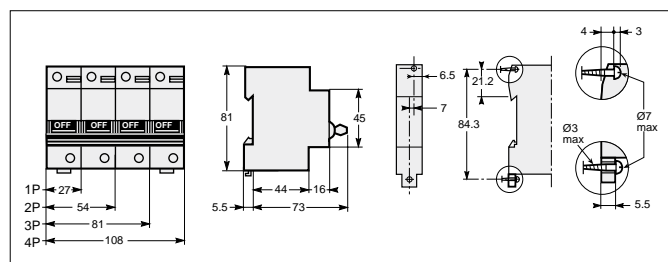

Vigi C120

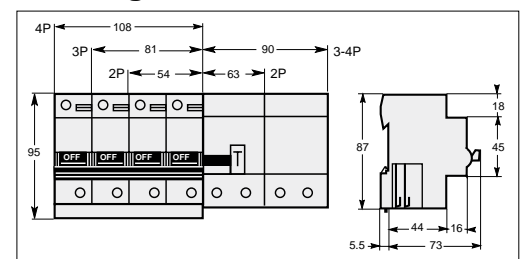

C60/C120 auxiliaries

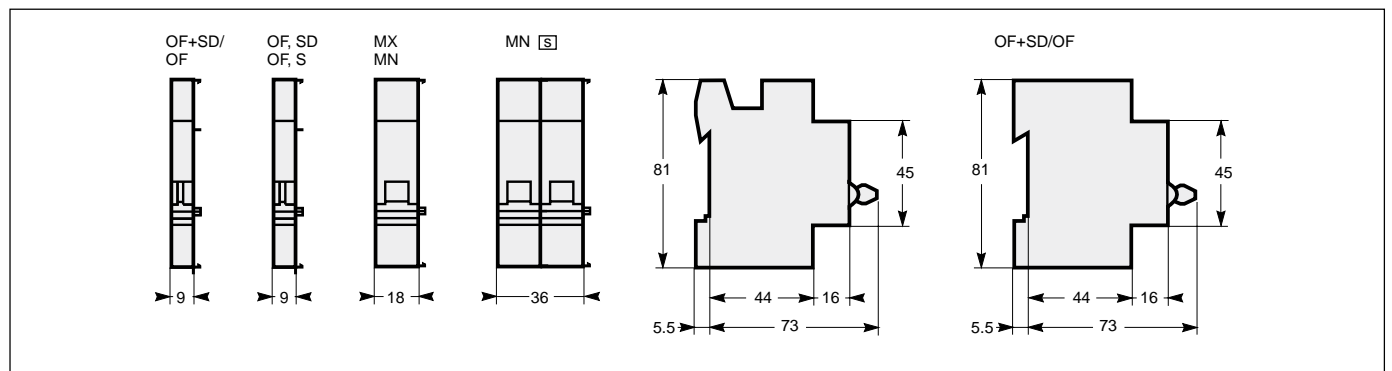

C60 accessories

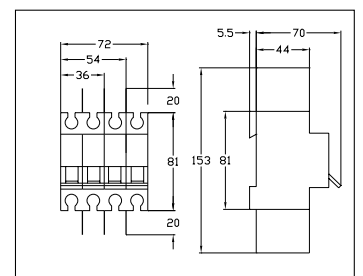
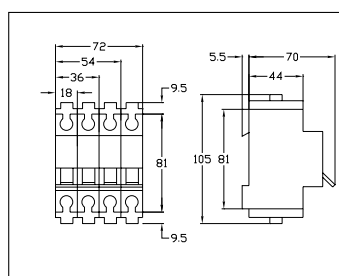
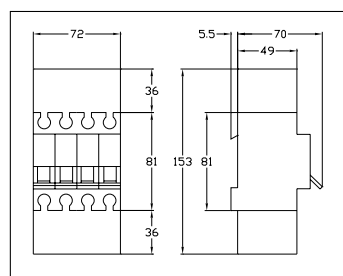

C120 accessories

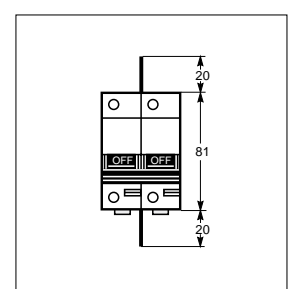
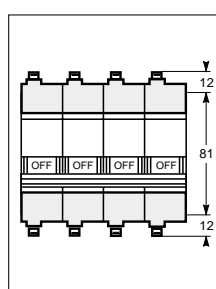
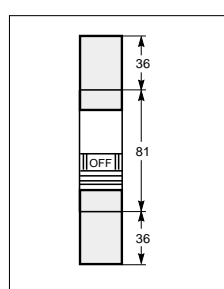

Dimensions

C32H-DC circuit breakers

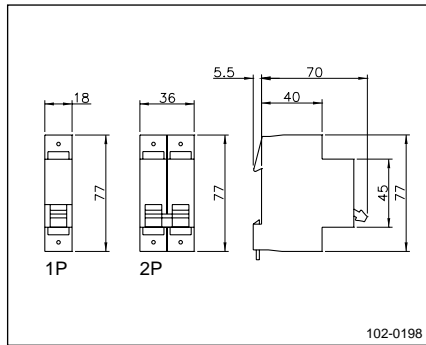

C32H-DC auxiliaries

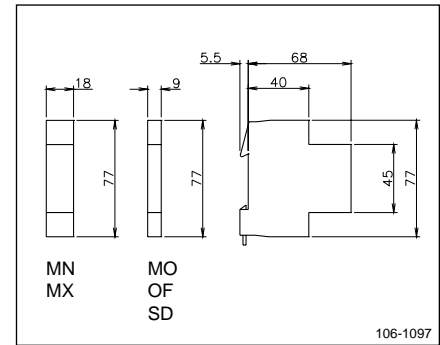

Tm C60/C120

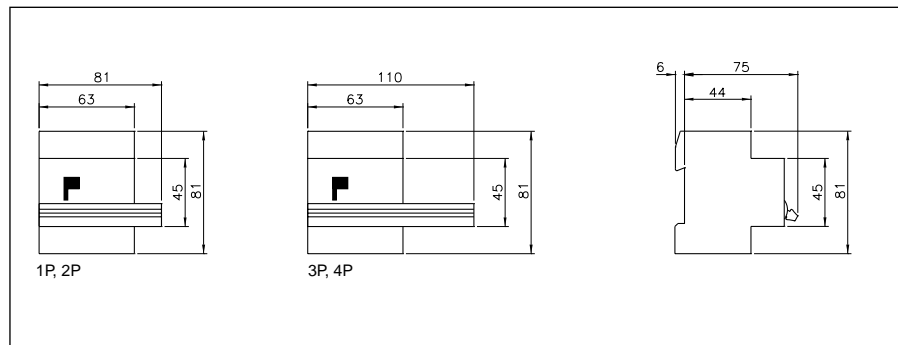

Locations

Head Office:

2 Solent Circuit, Norwest Business Park, Baulkham Hills NSW 2153 Tel: (02) 9851 2800

Sales Offices:

NSW
2 Solent Circuit, Norwest Business Park, Baulkham Hills NSW 2153 Tel: (02)9851 2800 Fax: (02) 9629 8555

VIC
77 Ricketts Road, Mt Waverley VIC 3149 Tel: (03) 9558 9876 Fax: (03) 9558 9701

SA
Building 1A, Corbett Court, Export Park, Adelaide Airport SA 5950 Tel: (08) 8234 4388 Fax: (08) 8234 4122

WA
26 Gibberd Road, Balcatta WA 6021 Tel: (08) 9344 2727 Fax: (08) 9344 6335

QLD
30 Graystone Street, Tingalpa QLD 4173 Tel: (07) 3890 2112 Fax: (07) 3890 2098

Regional Offices:

Albury - Tel: 0425 247 097 Fax: (02) 6059 1964 **Newcastle** - Tel: (02) 4952 6900 Fax: (02) 4952 9403

Ballarat - Tel: 0418 477 539 Fax: (03) 5330 4113 **Orange** - Tel: (02) 8813 5231 Fax: (02) 6362 1283

Cairns - Tel: 0407 257 643 Fax: (07) 4081 0972 **Rockhampton** - Tel: 0417 248 003 Fax: (07) 4926 8200

Darwin - Tel: 0417 660 435 Fax: (08) 8947 4498 **Wollongong** - Tel: 0413 433 907 Fax: (02) 4297 3970

Manufacturing Facilities

MV Transformers & Substations
Sydney Road, Benalla VIC Tel: (03) 5762 3411 Fax: (03) 5762 5113

MV Switchgear
77 Ricketts Road, Mt Waverley VIC Tel: (03) 9558 9876 Fax: (03) 9558 9600

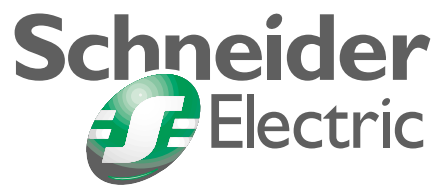

HELP CENTRE

Tel: 1300 369 233

Fax: 1300 369 288

Email: help@schneider.com.au

www.schneider.com.au

**Schneider Electric
(Australia) Pty Limited**

Postal Address:
Locked bag 5500
Baulkham Hills Business Centre
NSW 2153 Australia
Tel: +61 (2) 9851 2800

As standards, specifications and designs change from time to time, please ask for confirmation of the information given in this publication.

Publishing: Schneider Electric
Design, production: The Graphic Shop
Photos: Schneider Electric
Printing: TBA