

Fishing

Greenlee has the most innovative fishing systems designed to perform on the jobsite. Whether you're going a few short feet or through many walls and bends, having Greenlee's fishing products on the jobsite will make the job easier for any commercial, industrial or utility application.

Contents

Fish Tapes	132
Fish Stix®	136
Glow Stix®	136
Reachers	137
CableCaster®	138
Flashlights	138
Vacuum/Blower Systems	139
Measuring Tapes	144



GREENLEE®
A Textron Company

MADE FOR THE TRADE!™

FlexWORKS
DRW FUELING CONTAINMENT SYSTEMS



FISH TAPES

MagnumPRO[™] Oil-Tempered Spring Steel Fish Tapes

NEW



FTS438-125



FTS438-65



438-5H

- Oil-tempered spring steel for excellent fishing performance.
- Dirt-free tape finish keeps hands cleaner during use.
- Advanced comfort handle grip reduces fatigue.
- Superior rapid tape pay-out and rewind.
- Smaller Fish Eye with offset bend for improved fishing ability.
- Improved low profile tip for easy fishing through all sizes of conduit.
- Viewing Port gives visibility to remaining tape and ability to remove jobsite debris quickly.
- Rugged case design improves drop impact capability.
- Flared case with Grip Ridges for no slip handling.
- Available in 50' (15.2 m), 65' (19.8 m), 125' (38.1 m) and 240' (73.2 m) lengths.
- 1/8", 1/4" and flat steel profiles to accommodate different fishing situations.

CAT. NO.	UPC NO.	DESCRIPTION
438-5H	07500	Steel Fish Tape - 50' × 1/8" (15.2 m × 3.2 mm)
FTS438-65	12729	Steel Fish Tape - 65' × 1/8" (19.8 m × 3.2 mm)
FTS438-65BP	10028	Steel Fish Tape - 65' × 1/8" (19.8 m × 3.2 mm) 3-PACK
FTS438-125	12709	Steel Fish Tape - 125' × 1/8" (38.1 m × 3.2 mm)
FTS438-125BP	10046	Steel Fish Tape - 125' × 1/8" (38.1 m × 3.2 mm) 3-PACK
FTS438-240	12730	Steel Fish Tape - 240' × 1/8" (73.2 m × 3.2 mm)
FTS438-240BP	10048	Steel Fish Tape - 240' × 1/8" (73.2 m × 3.2 mm) 3-PACK
FTS438W-100	12710	Steel Fish Tape - 100' × 1/4" (30.5 m × 6.4 mm)
S438W-200	12476	Steel Fish Tape - 200' × 1/4" (61 m × 6.4 mm)
RS438-65	12469	R Replacement Steel Tape - 65' (NO CASE)
RS438-125	12470	R Replacement Steel Tape - 125' (NO CASE)
RS438-240	12471	R Replacement Steel Tape - 240' (NO CASE)
RS438W-100	12472	R Replacement Steel Tape - 100' × 1/4" (NO CASE)
R438B	29367	A Swivel Ball Head for use on 1/8" Steel Fish Tapes
R438-BM	05853	A Ball Tip Male Half
439-1	30859	A 12" (305 mm) Flexible Fish Tape Leader
439-2	14392	A 12" (305 mm) SPEED FLEX Leader (solder joints)
10051	10051	R 8 1/2" Case/Handle Replacement Kit
10052	10052	R 12" Case/Handle Replacement Kit

SPECIFICATIONS

Capacity	1/8" (3.2 mm) tape width- 400 lbs. (1.7 kN) maximum design strength	
	1/4" (6.4 mm) tape width - 400 lbs. (1.7 kN) maximum design strength.	
	438-5H - 1/8" (3.2 mm) tape width- 400lbs. (1.7 kN) maximum design strength.	
Weight	FTS438-65- 3.1 lbs. (1.4 kg)	S438W-200 - 10.9 lbs. (4.9 kg)
	FTS438-125 - 5.5 lbs. (2.5 kg)	438-5H - 2.8 lbs. (1.3 kg)
	FTS438-240 - 8.5 lbs. (3.9 kg)	438-2X - 1.3 lbs. (.6 kg)
	FTS438W-100 - 7.2 lbs. (3.3 kg)	

Fishing

INTERNATIONAL

Tel: + 1.815.397.7070
Fax: + 1.815.397.9247

CANADA

Tel: 800.435.0786
Fax: 800.524.2853

USA

Tel: 800.435.0786
Fax: 800.451.2632

Flat-Steel Fish Tape- 1/4" Wide



- Flat steel tape reaches easily above ceilings, under carpets, and through walls to install wire.
- 25' (7.6 m) long, extending your reach.
- Winder case with crank handle for easy, compact storage.

CAT. NO.	UPC NO.	DESCRIPTION
438-2X	01696	25' x 1/4" x 0.030" (7.6 m x 6.4 mm x 0.8 mm) Steel Fish Tape

SPECIFICATIONS

Weight 1.25 lb (0.6 kg)

MagnumPRO™ Stainless Steel Fish Tapes - 1/8" Wide

NEW



- Corrosion free stainless steel tape for maximum life.
- Fish further and faster with Speed Flex leader.
- Advanced comfort handle grip reduces fatigue.
- Viewing Port gives visibility to remaining tape and ability to remove jobsite debris quickly.
- Rugged case design improves drop impact capability.
- Flared case with Grip Ridges for no slip handling.
- Available in 100' (30.5 m) and 200' (61 m) lengths.
- Replacement Speed Flex leader.

CAT. NO.	UPC NO.	DESCRIPTION
FTSS438-100	12711	Stainless Steel Fish Tape - 100' x 1/8" (30.5 m x 3.2 mm)
FTSS438-200	12712	Stainless Steel Fish Tape - 200' x 1/8" (61 m x 3.2 mm)
RSS438-100	12480	R Replacement Stainless Steel Tape - 100' (NO CASE)
RSS438-200	12481	R Replacement Stainless Steel Tape - 200' (NO CASE)
439-2	14392	R 12" (305 mm) SPEED FLEX Leader (solder joints)
10052	10052	R 12" Case/Handle Replacement Kit

SPECIFICATIONS

Capacity 1/8" (3.2 mm) tape width-400 lbs. (1.7 kN) maximum design strength
Weight FTSS438-100 - 4.8 lbs. (2.2 kg);
 FTSS438-200 - 7.4 lbs. (3.4 kg)

MagnumPRO™ Flexible Steel Fish Tapes

NEW



- Multi-strand steel cable for maximum flexibility.
- Available in 50' (15.2 m) and 100' (30.5 m) lengths.
- Advanced comfort handle grip reduces fatigue.
- Viewing Port gives visibility to remaining tape and ability to remove jobsite debris quickly.
- Rugged case design improves drop impact capability.
- Flared case with Grip Ridges for no slip handling.

CAT. NO.	UPC NO.	DESCRIPTION
FTFS439-50	12713	Flexible Steel Fish Tape - 50' x 3/16" (15.2 m x 4.8 mm)
FTFS439-100	12714	Flexible Steel Fish Tape - 50' x 3/16" (30.5 m x 4.8 mm)
FS439-100	12482	Flexible Steel Fish Tape - 50' x 3/16" (15.2 m x 4.8 mm) Double Tip (NO CASE)
10052	10052	R 12" Case/Handle Replacement Kit

SPECIFICATIONS

Capacity 3/16" (4.8 mm) tape width - 500 lbs. (2.2 kN) maximum design strength.
Weight FTFS439-50 - 5.6 lbs. (2.5 kg);
 FTFS439-100 - 8.9 lbs. (4.0 kg);
 FS439-100 - 6.2 lbs. (2.8 kg)

Fishing

USA

Tel: 800.435.0786
 Fax: 800.451.2632

CANADA

Tel: 800.435.0786
 Fax: 800.524.2853

INTERNATIONAL

Tel: +1.815.397.7070
 Fax: +1.815.397.9247



MagnumPRO™ Fiberglass Fish Tapes

NEW



- Non-conductive fiberglass tape with patented low-friction coating for faster and easier fishing.
- Perfect for fishing in conduit with wire or cable present.
- Advanced comfort handle grip reduces fatigue.
- Superior rapid tape pay-out and rewind.
- Smaller Fish Eye with offset bend for improved fishing ability.
- Improved low profile tip for easy fishing through all sizes of conduit.
- Viewing Port gives visibility to remaining tape and ability to remove jobsite debris quickly.
- Rugged case design improves drop impact capability.
- Flared case with Grip Ridges for no slip handling.
- Available in 50' (15.2 m), 100' (30.5 m) and 250' (76.2 m) lengths.
- Replaceable tips.
- Exclusive, unique, lightweight reel for easy positive feed out and rewind.
- Excellent for installation of telecommunications and data communication cables in overhead plenums, above suspended ceilings and under floors.
- Fiberglass fish tape is the fastest manual fish tape available. It is intended for fishing only. Rope or line is recommended for pulling.

CAT. NO.	UPC NO.	DESCRIPTION
FTF540-50	12717	Fiberglass Fish Tape - 50' x 11/64" (15.2 m x 4.3 mm)
FTF540-100	12718	Fiberglass Fish Tape - 100' x 11/64" (30.5 m x 4.3 mm)
542-200	35746	Fiberglass Fish Tape 200' x 3/16" (61 m x 4.8 mm) IN REEL STAND
542-250	35747	Fiberglass Fish Tape 250' x 3/16" (76.2 m x 4.8 mm) IN REEL STAND
R540-100	35744	R Replacement Fiberglass Tape - 100' x 11/64" (NO CASE)
05157	05157	R Replacement Fiberglass Tape - 200' x 3/16" (NO CASE)
05158	05158	R Replacement Fiberglass Tape - 250' x 3/16" (NO CASE)
10565	10565	R Pulling Eye Repair Kit for 11/64" (4.3mm) Diameter Fish Tapes (Includes: pulling eye & adhesive)
35750	35750	R Accessory Kit for 3/16" (4.78 mm) Fish Tapes (Includes flexible pulling leader, flexible pushing leader, pulling eye, splice ferrule and threaded ferrule)
35908	35908	R 1/8" (3 mm) Repair Kit (Includes threaded end ferrule, splice ferrule and pulling eye)
35909	35909	R 3/16" (4.7 mm) Repair Kit (Includes threaded end ferrule, splice ferrule and pulling eye)
35919	35919	A 1/8" (3 mm) Pulling Eye
35930	35930	A 3/16" (4.7 mm) Pulling Eye
10052	10052	R 12" Case/Handle Replacement Kit

SPECIFICATIONS

Capacity	540 Series- 0.175" (4.4 mm) dia. - 300 lbs. (1.3 kN) maximum design strength
	542 Series-3/16" (4.7 mm) dia. - 400 lbs. (1.7 kN) maximum design strength
Weight	FTF540-50 - 2.8 lbs. (1.3 kg) FTF540-100 - 3.4 lbs. (1.5 kg) 542-200- 16 lbs. (7.2 kg) 542-250- 17 lbs. (7.7 kg)

Fishing

INTERNATIONAL

Tel: +1.815.397.7070
Fax: +1.815.397.9247

CANADA

Tel: 800.435.0786
Fax: 800.524.2853

USA

Tel: 800.435.0786
Fax: 800.451.2632

MagnumPRO™ Nylon Fish Tapes

NEW



- Non-conductive, curl resistant nylon tape for fast, clean fishing.
- Good for fishing in conduit with wire or cable present.
- Rugged case design improves drop impact capability.
- Advanced comfort handle grip reduces fatigue.
- Nylon fish tape is intended for fishing only. Rope or line is recommended for pulling.

CAT. NO.	UPC NO.	DESCRIPTION
FTN536-50	12715	Nylon Fish Tape 50' × 3/16" (15.2 m × 4.8 mm)
FTN536-100	12716	Nylon Fish Tape 100' × 3/16" (30.5 m × 4.8 mm)
RN536-50	12483	R Replacement Nylon Fish Tape 50' (NO CASE)
RN536-100	12484	R Replacement Nylon Fish Tape 100' (NO CASE)
01664	01664	R Replacement Tip for 436 Nylon Fish Tape (Requires Greenlee K05 or K09 series crimper or #6 hex crimp to install.)
10052	10052	R 12" Case/Handle Replacement Kit

SPECIFICATIONS

Capacity	3/16" (4.8 mm) diameter – 250 lbs. (1.1 kN) maximum design strength
Weight	FTN536-50 – 2.9 lbs. (1.3 kg) FTN536-100 – 3.6 lbs. (1.6 kg)

Flex-O-Twist® Flexible Fish Tape Leader



- Helps guide 1/8" steel tapes through sharp bends.
- Thread on the end of the fish tape in place of the swivel ball head.

CAT. NO.	UPC NO.	DESCRIPTION
439-1	30859	12" (305 mm) Flexible Fish Tape Leader

SPECIFICATIONS

Weight	1.3 lbs. (0.6 kg)
---------------	-------------------

SpeedFlex® Flexible Fish Tape Leader



- Silver-solder joint attaches to any 1/8" (3.2 mm) x .060" (1.5 mm) steel fish tape to provide a slim profile that fishes farther, faster.
- High-strength stainless steel cable is used for reliability and long life.
- Beveled edges on the leader reduce the possibility of hangups when pulling wire.
- Up to (6) #10 wires can be attached to the large pulling eye.

CAT. NO.	UPC NO.	DESCRIPTION
439-2	14392	12" (305 mm) SPEED FLEX Leader (solder joint)

SPECIFICATIONS

Weight	1.3 lbs. (0.6 kg)
---------------	-------------------

Fishing

USA

Tel: 800.435.0786
Fax: 800.451.2632

CANADA

Tel: 800.435.0786
Fax: 800.524.2853

INTERNATIONAL

Tel: +1.815.397.7070
Fax: +1.815.397.9247

Fish Stix[®]

- Highly visible green color rods can be easily threaded together and seen when working above ceilings, down walls, or under raised floors.
- 1/4" (6.4 mm) diameter fiberglass adds rigidity when connecting multiple sections.
- 200 lbs. (0.9 kN) maximum pulling strength.
- Two different threaded tips accommodate various bundles of wire or cable.
- 540-24 includes one 3' (0.9 m) Glo Stix[™] section for improved tip visibility.
- Optional Whisk Nose Tip is available for fishing over obstacles, and can be used to guide extended Glo Stix sideways above ceilings by rotating. Can also be used to fish longer lengths by providing a tip that can be snagged from the opposite direction with another extended Fish or Glo Stix with a hook nose tip.



Glo Stix[®]

- Luminescent fiberglass rods glow in the dark to make fishing voice, data and video wires easier in dark spaces, such as above ceilings, in walls, and below sub-floors.
- More flexible for fishing in walls through outlet box holes.
- Sturdy, steel-threaded connectors are interchangeable with Greenlee 1/4" (6.4 mm) Fish Stix.
- Clear, non-metallic storage tube keeps Glo Stix charged and ready to use.
- 200 lbs. (0.9 kN) maximum pulling strength.
- Optional Whisk Nose Tip is available for fishing over obstacles, and can be used to guide extended Glo Stix sideways above ceilings by rotating. Can also be used to fish longer lengths by providing a tip that can be snagged from the opposite direction with another extended Fish or Glo Stix with a hook nose tip.

CAT. NO.	UPC NO.	DESCRIPTION
540-12	10504	Fish Stix Kit: 1/4" x 12' (6.4 mm x 3.6 m) with bullet & "J" hook nose tips
540-24	10506	Fish Stix Kit: 1/4" x 24' (6.4 mm x 7.3 m) with bullet & "J" hook nose tips
IV 540-8M	12918	Glo Stix Kit: 3/16" x 8' long with bullet & "J" hook nose tips
540-15	11422	Glo Stix Kit: 3/16" x 15' (4.7 mm x 4.6 m) with bullet & "J" hook nose tips
540-6	86795	Glo Stix, single 5/32" x 6' (4.0 mm x 1.8 m) with fixed bullet nose on both ends
540-18	86796	Glo Stix Kit: 5/32" x 18' (4.0 mm x 5.5 m) with bullet & "J" hook nose tips
IV 540-20P	12919	Professional Installers Kit: (3)-1/4" x 4' Fish Stix sections, (2)-3/16" x 2' Glo Stix Sections & (1)-5/32" x 4' Glo Stix Section, (1) whisk, (1) "J" hook, (1) bullet nose
10497	10497	A Hook Nose Tip
10498	10498	A Bullet Nose Tip
11426	11426	A Whisk Nose Tip
11583	11583	R 1/4" x 4' (6.4 mm x 1.2 m) Fish Stix Section
11584	11584	R 1/4" x 6' (6.4 mm x 1.8 m) Fish Stix Section
IV 12920	12920	R 3/16" x 20" (4.7 mm x .5 m) Glo Stix Section
11585	11585	R 3/16" x 3' (4.7 mm x 0.9 m) Glo Stix Section
11427	11427	R 3/16" x 5' (4.7 mm x 1.5 m) Glo Stix Section
IV 12922	12922	R 5/32" x 4' (4.7 mm x 1.2 m) Glo Stix Section
89803	89803	R 5/32" x 6' (4.0 mm x 1.8 m) Glo Stix Section

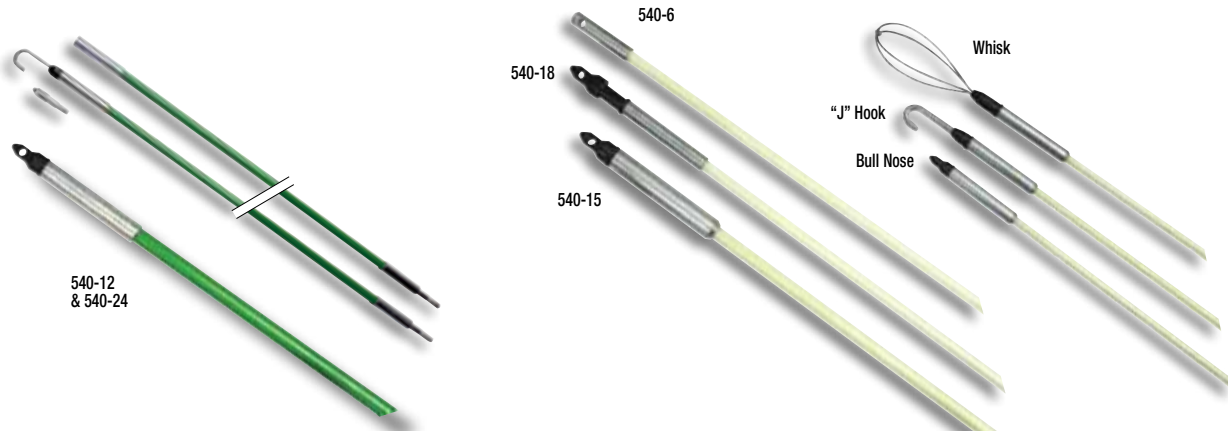

SPECIFICATIONS	FISH STIX [®]		GLOW STIX [®]				
	540-12	540-24	540-8M	540-15	540-6	540-18	540-20P
Overall Length	12' (3.6 m)	24' (7.3 m)	8' (2.4 m)	15' (4.6 m)	6' (1.8 m)	18' (5.5 m)	6' (1.8 m)
Sections	3	5	5	3	1	3	6
Section Length	4' (1.2 m)	(3) 6' (1.8 m), (1) 3' (0.9 m) & (1) 3' (0.9 m) Glo Stix Section	20" (.5 m)	5' (1.5 m)	6' (1.8 m)	6' (1.8 m)	†
Diameter	1/4" (6.4 mm)	1/4" (6.4 mm)	3/16" (4.8 mm)	3/16" (4.7 mm)	5/32" (4.0 mm)	5/32" (4.0 mm)	5/32" (4.0 mm)
Weight	1.04 lbs. (0.5 kg)	1.94 lbs. (0.9 kg)	.8 lbs. (0.4 kg)	1 lbs. (0.5 kg)	.4 lbs. (0.2 kg)	.8 lbs. (0.4 kg)	.4 lbs. (0.2 kg)
Material	Fish Stix	Fish Stix	Glo Stix	Glo Stix	Glo Stix	Glo Stix	Glo Stix
Minimum Bend Radius	6 1/2" (165 mm)	6 1/2" (165 mm)	4 1/4" (108 mm)	4 1/4" (108 mm)	3 1/2" (89 mm)	3 1/2" (89 mm)	3 1/2" (89 mm)

†540-20P includes: (3)-1/4" x 4' Fish Stix sections, (2)-3/16" x 2' Glo Stix Sections & (1)-5/32" x 4' Glo Stix Section.

3' Wire Reacher



- Extends your reach above ceilings and walls.
- Stainless-steel construction for long life.
- Hook can be used to install cables and wires up to 3/4" (19 mm) diameter.
- Clip included for easy storage in shirt pocket.
- Self-contained, no loose parts.

CAT. NO.	UPC NO.	DESCRIPTION
----------	---------	-------------

FP3	23902	3' Wire Reacher
-----	-------	-----------------

SPECIFICATIONS

Extended length:	38" (965 mm)
Collapsed length:	6-3/8" (162 mm)
Diameter:	3/8" (9.5 mm)
Weight:	1.6 oz (46 g)

Fish Poles



Designed specifically for pushing and pulling wires over long distances.

- Push or pull wires over suspended ceilings, under sub-floors or crawl spaces and in attics.
- Non-conductive, high-impact construction.
- Velcro strap secures pole when in collapsed position.
- Self-contained, no loose parts.
- Lightweight design to minimize fatigue.
- FP12 - Fish Pole 12' collapses to 26" x 1 1/4" and uses friction-locking system.
- FP18 - Fish Pole 18' collapses to 27" x 2" and uses friction-locking system.
- FP24 - Fish Pole 24' collapses to 50" x 2 1/4" and uses snap-lock buttons to maintain extended reach capabilities.
- Install suspension wires for drop ceilings.
- U.S. Patents #6,729,358 & #6,908,250

CAT. NO.	UPC NO.	DESCRIPTION
----------	---------	-------------

FP12	02268	Fish Pole 12 ft.
FP18	10442	Fish Pole 18 ft.
FP24	10443	Fish Pole 24 ft.
10453	10453	Replacement Hook

SPECIFICATIONS

	FP12 FISH POLE	FP18 FISH POLE	FP24 FISH POLE
Extended length:	12' (3.7 m)	18' (5.48 m)	24' (7.31 m)
Collapsed length:	26" (660 mm)	27" (686 mm)	50" (1270 mm)
Diameter:	1 1/4" (32 mm)	2" (50 mm)	2 1/4" (57 mm)
Weight:	1.3 lb. (0.6 kg)	2 1/2 lb. (1.1 kg)	4 1/4 lb. (1.9 kg)

Fishing

USA

Tel: 800.435.0786
Fax: 800.451.2632

CANADA

Tel: 800.435.0786
Fax: 800.524.2653

INTERNATIONAL

Tel: +1.815.397.7070
Fax: +1.815.397.9247



CableCaster®



Significantly speeds up the installation of lightweight communications cable through hard-to-reach spaces such as suspended ceilings, rafters and sub-floors.

- 50' (15 m) range allows for faster installations with fewer pulls.
- Bright yellow body reduces chances of leaving the CableCaster behind.
- Glow-in-the-dark darts minimize replacement costs because they are easy to locate.
- Aerodynamic darts provide high accuracy and fast installation.
- Optional flashlight improves visibility.

CAT. NO.	UPC NO.	DESCRIPTION
06186	06186	CableCaster Wire Pulling Tool with Three Darts
06259	06259	CableCaster Replacement Darts (Pack of Four)
46500	46500	Pocket-Light Flashlight

Pocket-Light Flashlight



- High intensity Xenon fired lamp.
- Luminous tip so flashlight can be located in the dark.
- Lifetime limited warranty.
- Submersible to 500 feet.
- Dust and rust proof
- (2) AAA Batteries included.

CAT. NO.	UPC NO.	DESCRIPTION
46500	46500	Pocket-Light Flashlight
46533	46533	Lamp Module
46534	46534	O-Ring

Mini Pocket-Light Flashlight



- High intensity Xenon fired lamp.
- Submersible to 500 feet.
- (2) AAA Batteries included.
- Compact pocket and key chain light.
- Includes key ring and handy hat/clothing clip.
- Dust and rust proof.

CAT. NO.	UPC NO.	DESCRIPTION
46503	46503	Mini Pocket-Light Flashlight
46533	46533	Lamp Module
46534	46534	O-Ring

690 Vacuum/Blower Power Fishing System



NRTL/C

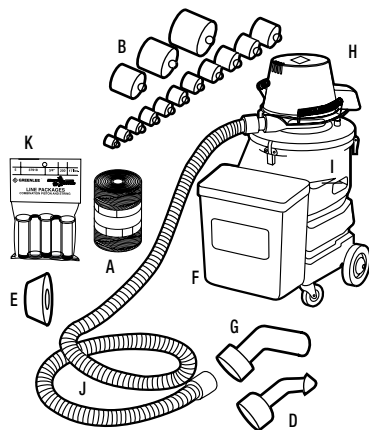

- Rugged, self-contained unit includes everything you need to blow or vacuum fish line, poly line or measuring tape.
- Durable tank and accessory storage box are corrosion, chemical and impact-resistant polyethylene.
- Designed for the jobsite, 10' (3.05 m) long hose, large heavy-duty wheels and removable accessory box.
- Large 11 gallon (41.6 l) tank makes the 690 excellent for vacuuming water and debris.

CAT. NO.	UPC NO.	DESCRIPTION
690	31339	Vacuum/Blower Power Fishing System - 120 VAC
618	16517	A Piston for 5" Conduit
619	16951	A Piston for 6" Conduit
16646	16646	A Accessory - Adapter for 5" - 6" conduit

KEY	CAT. NO.	UPC NO.	DESCRIPTION	690/ 31339
A	595	32433	Fish Line – 85 lbs. (378 N) pulling strength; 2,150' (655 m) long	1
B	*		Piston set for 1/2"-4" conduit (EMT & Rigid) see page 142 for replacements	
C	25644	25644	Adapter Cone 1-1/4"-2-1/2" Conduit	1
D	25646	25646	Adapter Cone 1/2"-1" Conduit	1
E	25645	25645	Adapter Cone 3"-4" Conduit	1
F	34027	34027	Storage Box	1
G	23360	23360	Adapter Nozzle for tape and line	1
H	32116	32116	Blower and Vacuum Unit	1
I	34392	34392	Tank with casters	1
J	38624	38624	Flexible Hose 1-1/2" x 10' (38.1mm x 3.05 m)	1
	31315	31315	Outer Filter Bag	1
	31314	31314	Inner Filter Bag	1
K	37917-10	06274	1/2" Conduit x 150' (46 m) Line Pkg.	10
K	37918-5	06275	3/4" Conduit x 200' (61 m) Line Pkg.	5
K	37920-5	06277	3/4" Conduit x 450' (137 m) Line Pkg.	5
K	37921-5	06278	1" Conduit x 200' (61 m) Line Pkg.	5
K	37923-5	06280	1" Conduit x 450' (137 m) Line Pkg.	5

SPECIFICATIONS

Capacity	1/2" - 4" Conduit (5" and 6" with optional foam pistons) see page 142
Power Source	120 VAC
Weight	50 lbs. (22.7 kg)
Air Flow	120 cfm
Pressure	Will lift 110" (2794 mm) of water

Fishing

USA

Tel: 800.435.0786
Fax: 800.451.2632

CANADA

Tel: 800.435.0786
Fax: 800.524.2853

INTERNATIONAL

Tel: +1.815.397.7070
Fax: +1.815.397.9247

Li'l Fisher[®] 390 Power Fishing System



390

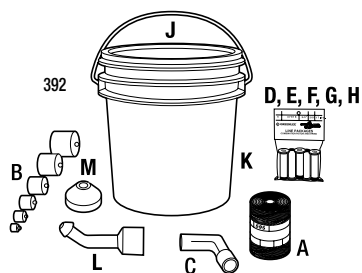

CAT. NO.	UPC NO.	DESCRIPTION
390	38594	Li'l Fisher Vacuum/Blower Power Fishing System - Includes only unit and 38624 hose
392	39051	A Power Fishing System Accessory Kit- Includes all items below

392 / 39051 ACCESSORY KIT INCLUDES:

KEY	CAT. NO.	UPC NO.	DESCRIPTION	QTY.
A	595	32433	Fish Line – 85 lbs. (378 N) pulling strength; 2,150' (655 m) long	1
B	*		Piston for 1/2" Conduit	1
B	*		Piston for 3/4" Conduit	1
B	*		Piston for 1" Conduit	1
B	*		Piston for 1-1/4" Conduit	1
B	*		Piston for 1-1/2" Conduit	1
B	613	16511	Piston for 2" Conduit	1
C	23360	23360	Adapter Nozzle for Measuring Tape	1
D	37917-10	06274	1/2" Conduit x 150' (46 m) Line Pkg.	10
E	37918-5	06275	3/4" Conduit x 200' (91 m) Line Pkg.	5
F	37920-5	06277	3/4" Conduit x 450' (137 m) Line Pkg.	5
G	37921-5	06278	1" Conduit x 200' (61 m) Line Pkg.	5
H	37923-5	06280	1" Conduit x 450' (137 m) Line Pkg.	5
J	39063	39063	Accessory Container Lid	1
K	54284	54284	Accessory Container	1
L	25646	25646	1/2"-1" Cone adapter	1
M	25644	25644	1-1/4"-2-1/2" Cone adapter	1

*See page 142 for replacement conduit pistons.

SPECIFICATIONS

Capacity	1/2"-2" conduit with optional Accessory Kit (2-1/2"-4" with optional foam pistons) Liquid Capacity- 1.75 gal. (6.5 l) Use 690 Power Fishing System for greater liquid capacity requirements
Power Source	120 VAC, 1/2 H.P.
Weight	390-19 lbs. (8.6 kg)
Air Flow	101.2 cfm (2.83 cMm)
Vacuum Lift	137.1" (3482 mm) of Water

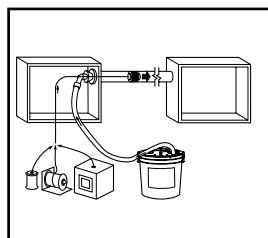

Blowing a piston through conduit using 390 Li'l Fisher[™] Power Fishing System. Can be used with fish line, poly line or measuring tape.

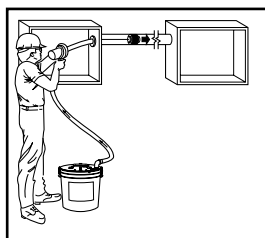

Blowing a piston through conduit using 390 Li'l Fisher[™] Power Fishing System using 691 Blow Gun with 595 Mighty Mouser[®] Fish Line.

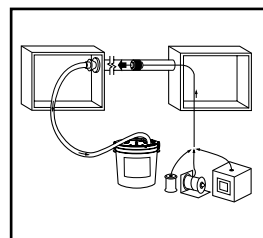

Vacuuming a piston through conduit using 390 Li'l Fisher[™] Power Fishing System. Can be used with fish line, poly line or measuring tape.

Fishing

INTERNATIONAL

Tel: +1.815.397.7070
Fax: +1.815.397.9247

CANADA

Tel: 800.435.0786
Fax: 800.524.2853

USA

Tel: 800.435.0786
Fax: 800.451.2632

Portable Blower Power Fishing System



- Powerful, will blow line or measuring tape in up to 6" conduit.
- Portable, lightweight blower has shoulder strap to make it easy to carry and allow the operator to have both hands free.
- Efficient, includes the Mighty Mouser® blow gun for fast, easy line blowing.

CAT. NO.	UPC NO.	DESCRIPTION
591	32432	Portable Blower Power Fishing System
618	16517	A Piston for 5" Conduit
619	16951	A Piston for 6" Conduit
16646	16646	A Adapter for 5" - 6" conduit

SPECIFICATIONS

Capacity	1/2" - 4" Conduit (5" and 6" with optional foam pistons)
Power Source	120 VAC 20 Amp
Weight	34 lbs. (15.2 kg)

*See next page for parts list.

Mighty Mouser® Blow Gun Kit



- This compact, self-contained Lexan® thermoplastic blow gun holds a 2,150' (655 m) package of 85 lb. (378 N) breaking strength fish line.
- Compact self-contained unit leaves one hand free for more efficient operation.
- Mighty Mouser® Blow Gun and Accessories all fit into a compact sturdy metal case.

CAT. NO.	UPC NO.	DESCRIPTION
592	32565	Mighty Mouser® Blow Gun Kit for 1/2" - 4" Conduit in metal box
691	32095	R Mighty Mouser Blow Gun (only)
595	32433	A Fish Line - 85 lbs. (378 N) pulling strength; 2,150' (655 m) long
618	16517	A Piston for 5" Conduit
619	16951	A Piston for 6" Conduit
16646	16646	A Adapter for 5" - 6" conduit

SPECIFICATIONS

Capacity	1/2" - 4" conduit, through 6" with additional optional accessories
Power Source	Use with blower power fishing systems
Weight	592-20 lbs. (9 kg) 691-1.7 lbs.(0.8 kg)

*See next page for parts list.

Fishing

USA

Tel: 800.435.0786
Fax: 800.451.2632

CANADA

Tel: 800.435.0786
Fax: 800.524.2853

INTERNATIONAL

Tel: +1.815.397.7070
Fax: +1.815.397.9247

Parts List for Models 591 and 592

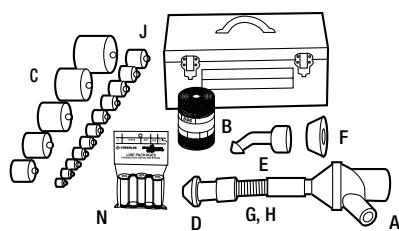

592 Mighty Mouser® Blow Gun Kit

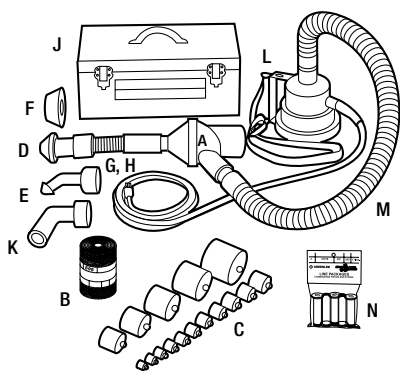

591 Portable Blower Power Fishing System

KEY	CAT. NO.	UPC NO.	DESCRIPTION	592	591
A	691	32095	Mighty Mouser® Blow Gun	1	1
B	595	32433	Fish Line – 85 lbs. (378N) pulling strength; 2,150' (655 m) long	1	1
C	*		Piston set for 1/2"-4" conduit (EMT & Rigid)		
D	25644	25644	Adapter Cone 1-1/4"-2-1/2" Conduit	1	1
E	25646	25646	Adapter Cone 1/2"-1" Conduit	1	1
F	25645	25645	Adapter Cone 3"-4" Conduit		1
G	32104	32104	Flexible Hose 1-1/2" dia. x 1' (38.1 mm x 305 mm)	1	1
H	33451	33451	Hose Clamp	1	1
J	32662	32662	Storage Box	1	1
K	23360	23360	Adapter Nozzle for Tape and Line		1
L	590	32422	Portable Blower		1
M	32431	32431	Flexible Hose 1-1/2" x 4' (38.1 mm x 1.2 m)		1
N	37917-10	06274	1/2" Conduit x 150' (46 m) Line Pkg.	10	10
N	37918-5	06275	3/4" Conduit x 200' (61 m) Line Pkg.	5	5
N	37920-5	06277	3/4" Conduit x 450' (137 m) Line Pkg.	5	5
N	37921-5	06278	1" Conduit x 200' (61 m) Line Pkg.	5	5
N	37923-5	06280	1" Conduit x 450' (137 m) Line Pkg.	5	5

*See below

Conduit Pistons



- Use with blower or vacuum power fishing system to pioneer the line through the conduit run.
- Flexible foam body for an air-tight seal.
- Color-coded end disk with embossed size markings for fast, easy selection.
- Strong steel center rod with loops on both ends.
- Pistons available for all types and sizes of conduit 1/2" through 6".

INDIVIDUAL PISTONS

CAT. NO.	UPC NO.	PACKAGE	CONDUIT SIZE	CONDUIT TYPE	COLOR
608-5	08263	POP	1/2"	All	Green
608	11038	Bulk	1/2"	All	Green
609-5	08264	POP	3/4"	All	Green
609	11039	Bulk	3/4"	All	Green
610-5	08265	POP	1"	All	Green
610	11040	Bulk	1"	All	Green
611-3	08266	POP	1-1/4"	All	Green
611	11041	Bulk	1-1/4"	All	Green
612-2	08267	POP	1-1/2"	All	Green
612	11042	Bulk	1-1/2"	All	Green
613	16511		2"	All	Green
614	16512		2-1/2"	IMC, Rigid	Green
621	19107		2-1/2"	EMT	Yellow
615	16513		3"	IMC, Rigid	Green
622	19109		3"	EMT	Yellow
616	16514		3-1/2"	IMC, Rigid	Green
646	24326		3-1/2"	EMT	Yellow
617	16515		4"	IMC, Rigid	Green
623	19110		4"	EMT	Yellow
618	16517		5"	All	Green
619	16951		6"	All	Green

PISTON SETS

CAT. NO.	UPC NO.	CONDUIT SIZES AND TYPE
S2613	26777	1/2", 3/4", 1", 1-1/4", 1-1/2" and 2" EMT, IMC and Rigid
34317	34317	2-1/2", 3", 3-1/2" and 4" EMT

Fishing

INTERNATIONAL

Tel: +1.815.397.7070
Fax: +1.815.397.9247

CANADA

Tel: 800.435.0786
Fax: 800.524.2853

USA

Tel: 800.435.0786
Fax: 800.451.2632

Fish Line



- Strong, lightweight nylon.
- 595 – Center feed for fast payout without tangling. Use with Mighty Mouser® blow gun.
- 604, 605, 606 and 607 – Specially wound to payout fast from outside without tangles.
- Mildew-resistant, can be pulled into the run with the wire to provide a means to add wires later.

CAT. NO.	UPC NO.	STRENGTH		LENGTH	
		LBS.	N	FT	m
595	32433	85	378	2150	655
604	23368	85	378	2200	670
605	16504	45	200	2750	838
606	16505	72	320	1700	517
607	16506	90	400	1350	411

Line Packages

- Combination piston and string all in one.
- Blow or vacuum through, leaving a lightweight line strong enough to pull a rope.
- 17 lb. breaking strength.



CONDUIT SIZE	LENGTH		COLOR	BOXED			BAGGED		
	FT.	m		CAT. NO.	UPC NO.	PER BOX	QTY. CAT. NO.	UPC NO.	QTY. PER BAG
1/2"	150	46	Red	—	—	—	37917-10	06274	10
3/4"	300	91	Yellow	37909-25	06265	25	37919-5	06276	5
3/4"	450	137	Yellow	37910-25	06266	25	37920-5	06277	5
1"	300	91	White	37912-25	06268	25	37922-5	06279	5
1"	450	137	White	37913-25	06269	25	37923-5	06280	5

Poly Line



430

430-500 Poly Line →

- Ready-to-use, pre-punched hole in lid with resealable cap.
- Use with power fishing systems directly from the container.
- Resists tangling when dispensing.
- Rot and mildew resistant.
- Handy reusable plastic dispenser pail with handle keeps the line dry.
- Use to pull rope through conduit.

CAT. NO.	UPC NO.	DESCRIPTION
430	21481	Poly Line 6500' (1981 m), Green Tracer
430-500	12598	Poly Line 500' (152 m), Green Tracer
431	21482	Poly Line 5200' (1585 m), Yellow Tracer
37959	37959	Poly Line 2200' (670 m), Red Tracer

SPECIFICATIONS

Capacity	430 and 430-500 - 210 lbs. (934 N) average breaking strength
	431 - 240 lbs. (1 kN) average breaking strength
	37959 - 500 lbs. (2.2 kN) average breaking strength
Weight	430 - 11 lbs. (5 kg)
	430-500 - 1 lb. (0.5 kg)
	431 - 12 lbs. (5.4 kg)
	37959 - 12 lbs. (5.4 kg)

Fishing

USA

Tel: 800.435.0786
Fax: 800.451.2632

CANADA

Tel: 800.435.0786
Fax: 800.524.2853

INTERNATIONAL

Tel: +1.815.397.7070
Fax: +1.815.397.9247

MEASURING TAPES

High-Strength Polyaramid Measuring/Pulling Tapes



- Pull small cables or install pull rope for large cable pulling jobs.
- Made of Polyaramid (equivalent to Kevlar[®]), will not rot or deteriorate. Can be left in ducts indefinitely for future use.
- Low stretch properties make measurements accurate.
- Printed measurements every foot from zero to 3000' (914 m).
- Use 406 Dispenser (see page 165).

CAT. NO.	UPC NO.	DESCRIPTION
39243	39243	Conduit Measuring Tape 1/4" x 3000' (6.4 mm x 914 m)
39244	39244	Conduit Measuring Tape 3/8" x 3000' (9.5 mm x 914 m)
39245	39245	Conduit Measuring Tape 1/2" x 3000' (12.7 mm x 914 m)

SPECIFICATIONS

Cat. No.	Average Breaking Strength	Length	Weight
39243	1250 lbs. (5.56 kN)	3000' (914 m)	10.5 lbs. (4.8 kg)
39244	1800 lbs. (8.01 kN)	3000' (914 m)	14.5 lbs. (6.6 kg)
39245	2500 lbs. (11.12 kN)	3000' (914 m)	18 lbs. (8.2 kg)

* Kevlar is a registered trademark of E. I. DuPont, Inc.

High-Strength Polyester Measuring/Pulling Tapes

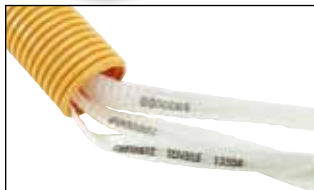

- Durable and stretch-resistant tape for easily pulling and installing wire and fiber optic cables within PVC and HDPE ducts.
- Factory-lubricated to reduce burn-through in innerduct.
- Easy-to-read footage markings for quick and accurate measurements.
- Available in various tensile strengths for use in any application.

CAT. NO.	UPC NO.	DESCRIPTION
4435	10445	Polyester Measure/Pulling Tape 1/2" x 3,000' (12.7 mm x 914m)
4436	10446	Polyester Measure/Pulling Tape 5/8" x 3,000' (15.9 mm x 914m)
4437	10447	Polyester Measure/Pulling Tape 3/4" x 3,000' (19.1 mm x 914m)

SPECIFICATIONS

Cat. No.	Average Breaking Strength	Length	Weight
4435	1250 lbs. (5.56 kN)	3000' (914 m)	23.6 lbs. (10.7 kg)
4436	1800 lbs. (8.01 kN)	3000' (914 m)	31.2 lbs. (14.2 kg)
4437	2500 lbs. (11.12 kN)	3000' (914 m)	39.4 lbs. (17.9 kg)

Polyester Measuring Tape and Dispenser



435 Measuring Tape shown on 434 Dispenser - sold separately.

- Fish and measure conduit runs in one operation.
- Permanently printed measurements every foot from zero to 3000' (914 m).
- Made of strong, waterproof polyester.
- Pay-out dispenser has anti-skid pads, handle and built-in cutter.

CAT. NO.	UPC NO.	DESCRIPTION
435	21562	Conduit Measuring Tape 3/16" x 3000' (4.8 mm x 914 m)
434	21875	Pay-Out Dispenser for 435 Conduit Measuring Tape

SPECIFICATIONS

Size	3000' (914 m)
Capacity	170 lbs. (756 kN) average breaking strength
Weight	435: 4.4 lbs. (2.0 kg), 434: 3.5 lbs. (1.6 kg)

Fishing

INTERNATIONAL

Tel: +1.815.397.7070
Fax: +1.815.397.9247

CANADA

Tel: 800.435.0786
Fax: 800.524.2853

USA

Tel: 800.435.0786
Fax: 800.451.2632