



# GIOVENZANA INTERNATIONAL B.V

TECHNO-CONTROL EQUIPMENT



AUTOMATION



LIFT



LIFTING EQUIPMENT

## GENERAL CATALOGUE



**GIOVENZANA**  
**INTERNATIONAL B.V.**

TECHNO-CONTROL EQUIPMENT

**GENERAL CATALOGUE**

**GIOVENZANA INTERNATIONAL** reserves the right to modify, in order to improve their performance, all technical and functional characteristics of the products showed on the catalogue without prior notice as these information are intended for general knowledge and they are not legally binding.

# GIOVENZANA INTERNATIONAL B.V.

The Company



TECHNO-CONTROL EQUIPMENT

## THE PHILOSOPHY

**Giovenzana's** philosophy is based upon the basic principles of business management, dynamism and the continuous research for the operator's needs in the field of man-machine interaction. These principles, thanks to the experience and professionalism of its staff, guarantees **Giovenzana's** development and growth.

## THE HISTORY

With over 50 years experience in this field and excellent managerial skills, **Giovenzana** has maintained growth relying upon:

- market research
- product placement
- manufacturing technology, and above all, team work

## THE PRODUCTS

**Giovenzana**, leader in the industrial technology field, is the first choice for:

- handling equipment
- automation
- lifting equipment
- maintenance
- command and control of moving parts

Development, design and production are combined together to reach a common aim and cover most industrial applications.

## QUALITY AS A WAY OF LIFE

The commercial success of a product is not by chance, but it is the end result of a combined effort of all human resources operating within an organisational structure devoted to quality. **Giovenzana** is an ISO 9001 certified company.



# GIOVENZANA INTERNATIONAL B.V.

The Company

## THE PRODUCTION

The solutions offered by **Giovenzana** are the outcome of a close examination of the requirements of industrial electrical accessories, in line with all relevant international standards.

It comprises three main sectors:  
Industrial automation, lift and lifting equipment.

## AUTOMATION

It includes Phoenix cam switches and Regolus switch-disconnectors up to 100A, Pegasus control auxiliaries with screw or spring loaded terminal contact blocks; limit switches with die-cast or moulded casing and safety switches; foot switches and micro switches.

## LIFT

Throughout the years, the continuous technological research and development made **Giovenzana** the undisputed leader in this field. The range includes: pit bottom push button stations, recall drive control units and inspection boxes.

## LIFTING EQUIPMENT

It comprises single and double row pendant stations up to 14 gang for control and direct switching power circuits, reversing switches, worm screw and rotary limit switches, slip rings, horns, festoon systems and conductor rails.





## QUALITY

**Giovenzana**, leader in the elevator and lifting equipment fields, has gained a prominent position in the automation sector as well with the launch of industrial control accessories on the market. For many years now, all commercial and industrial operations are integrated within the frame of the UNI EN ISO 9001 quality system.

### CSQ certificate No. 9105

Giovenzana has fulfilled its commitment to the quality of its products in 1995.

The quality system is the guarantee to the end user that all production stages are maintained under strict control and adhere to the requirements set by the company both in terms of customer expectations and compliance with the relevant international standards as proved by the various certificates held by Giovenzana for its products.



## COMPLIANCE

All **Giovenzana** products are manufactured according to the relevant Cee directives and are provided with a declaration of conformity which certifies their compliance.

## CERTIFICATIONS

For many years, **Giovenzana** has been submitting its products for third party testing to one of the most prestigious independent certification body around the world, the Underwriter Laboratories Inc. in order to obtain the UL mark. Today the number of independent certification bodies approving **Giovenzana's** products is even bigger to signal the high level of quality achieved.

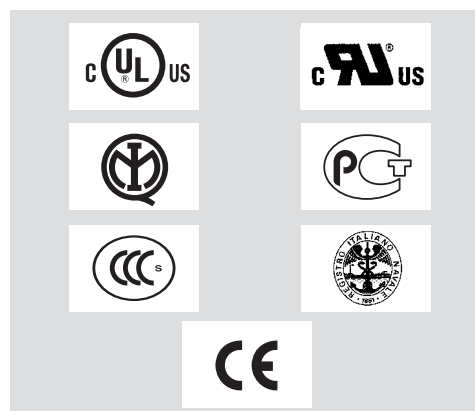

# GIOVENZANA INTERNATIONAL B.V.

## Certifications

### CEE DIRECTIVES

As from the 1st of January 1997, it is compulsory to CE mark all electromechanical products: this has been outlined by two important regulations: 72/23 CEE and 93/68 CEE Low Voltage Directives.

### CE MARK

European directives, applied to all national regulations, set the minimum requirements in term of safety of all electrical material sold within the EU. The compliance to these requirements is certified to the manufacturer by the CE mark placed on the products.

### STANDARDS

Giovenzana's products comply with both European EN and American UL standards. These regulations, such as the EN 60024 with regards to the safety requirements of the electrical circuits on board industrial machinery, define the characteristics and performance or the characteristics and use of the products.

### EN EUROPEAN STANDARDS

These standards are the result of the harmonisation among CENELEC (European Committee for Electrotechnical Standardization) member countries. They cover and eliminate existing national standards which may be in contradiction or not up to date. EN European standards usually originate from IEC International standards.





## AUTOMATION

- Phoenix cam switches ..... pag. 11
- Regolus switch-disconnectors ..... pag. 35
- Pegasus control auxiliaries ..... pag. 45
- Limit switches ..... pag. 71
- Microswitches ..... pag. 95
- Foot switches ..... pag. 97

## LIFT

- Pit bottom push button stations ..... pag. 103
- Recall drive control units

## LIFTING EQUIPMENT

- Pendant stations for: Small hoist applications ..... pag. 113
- Control circuits - Direct switching power circuits
- Tail lift push button stations
- Reversing switches ..... pag. 132
- Rotary cross bar and rotary gear limit switches ..... pag. 133
- Slip rings ..... pag. 137
- Horns ..... pag. 141
- Festoon systems ..... pag. 143
- Conductor rails ..... pag. 164



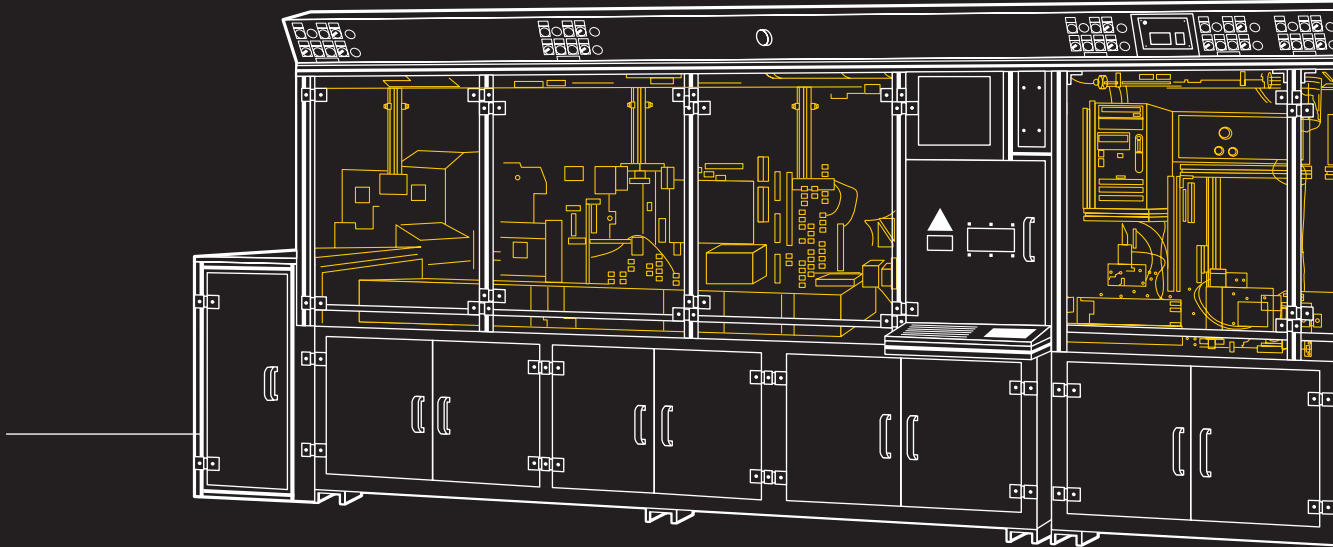

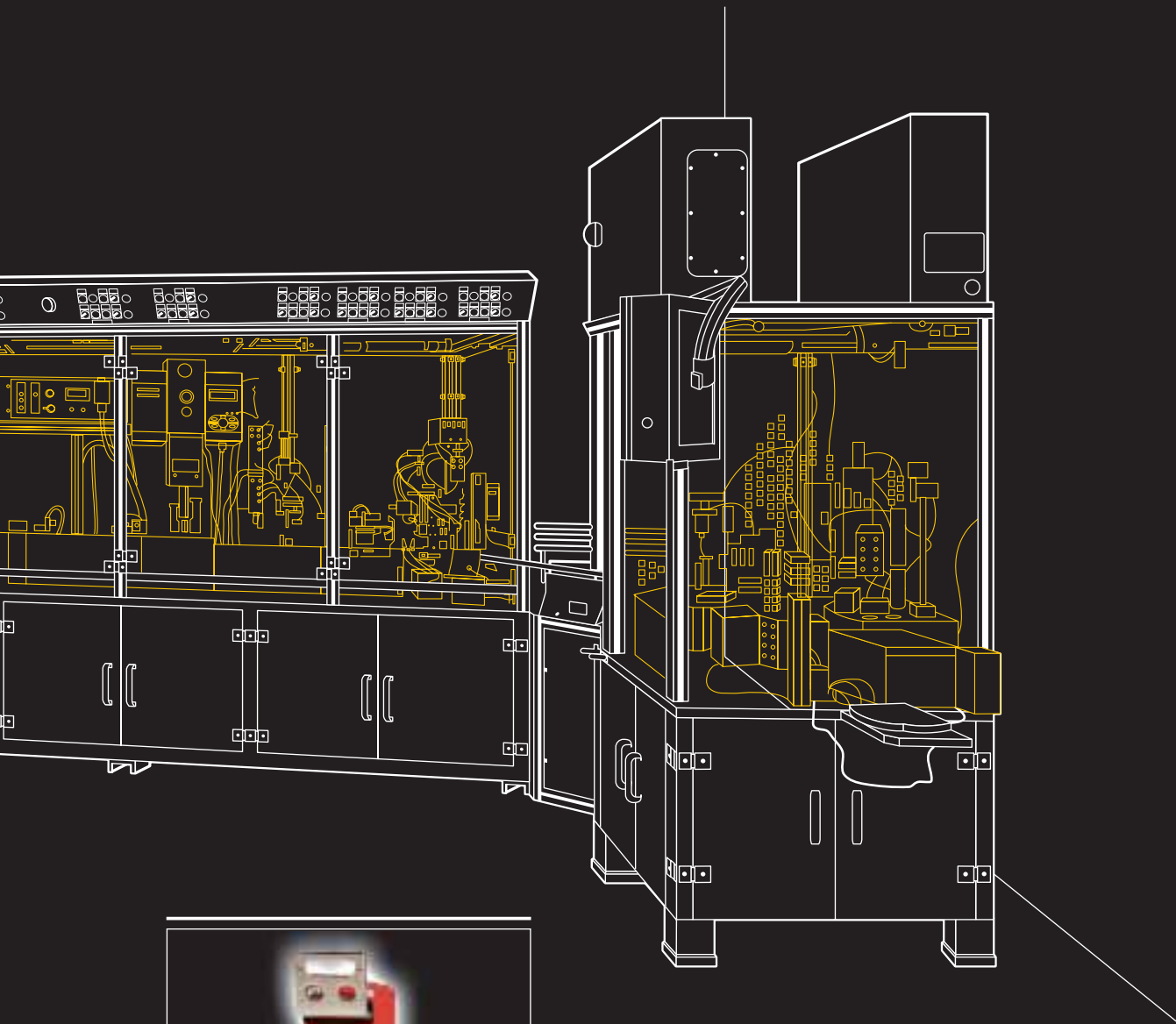



# Phoenix

## Cam switches

Table of contents



TECHNO-CONTROL EQUIPMENT



Current rating from 12 up to 40A. Base, DIN and panel mounted with fixing screws or  $\varnothing$  22.5 holes. Wide range of circuit diagrams available. Special version made to order.

### TABLE OF CONTENTS

■ Range overview	pag. 12	■ Panel-mounted step switches - DIN rail mounted Instrumentation switches	pag. 26
■ Panel-mounted switches	pag. 13	■ Special switches	pag. 27
■ Box-DIN rail mounted switches	pag. 19	■ Accessories	pag. 28
■ Panel-mounted line changeover switches	pag. 21	■ Technical data	pag. 30
■ Panel-mounted motor changeover switches	pag. 22	■ Dimensions	pag. 32
■ Instrumentation switches – Changeover without off switches	pag. 25	■ Circuit diagrams	pag. 34

# Phoenix

## Control switches

Range overview

### PO12 - PO16 - PO20 SERIES



- Panel mounting by means of horizontal fixing holes, 28 mm distance, for M3 screws or vertical fixing holes, 32 mm distance, for self tapping screws.
- Wafers secured by means of screws
- Metal shaft as standard
- IP20 rated terminals

### CO12 - CO16 - CO20 SERIES



- Panel mounting by means of vertical fixing holes for self tapping screws
  - Wafers secured by means of clip-on tie rod
  - Moulded shaft as standard
  - IP20 rated terminals
- \*Replace the letter "P" with "C" to order this range.  
PO12... becomes CO12...

### CO25 - CO32 - CO40 SERIES



- Panel mounting by means of horizontal fixing holes for M3 screws
- Wafers secured by means of screws
- Metal shaft as standard
- IP20 rated terminals

### CX25 - CX32 - CX40 SERIES



- Panel mounting by means of horizontal fixing holes for M3 screws
  - Wafers secured by means of screws
  - Metal shaft as standard
  - IP10 rated terminals for special applications
- \*Replace the number "O" with the letter "X" to order this range.  
CO25... becomes CX25...

# Phoenix

## Control switches

Panel mounting



TECHNO-CONTROL EQUIPMENT



Standard control knob

001  48  
007  64

SERIES	NOM. CURRENT AC21A AMP.	MARKING	1-POLE 1 WAFER	2-POLE 1 WAFER	3-POLE 2 WAFERS	4-POLE 2 WAFERS	5-POLE 3 WAFERS	6-POLE 3 WAFERS
P012	12	<input type="checkbox"/> 48 <input type="checkbox"/>	P0120001R001	<b>P0120002R001</b>	P0120003R001	<b>P0120004R001</b>	P0120005R001	<b>P0120006R001</b>
P016	16		P0160001R001	<b>P0160002R001</b>	P0160003R001	<b>P0160004R001</b>	P0160005R001	<b>P0160006R001</b>
P020	20		P0200001R001	<b>P0200002R001</b>	P0200003R001	<b>P0200004R001</b>	P0200005R001	<b>P0200006R001</b>
C025	25		C0250001R001	<b>C0250002R001</b>	C0250003R001	<b>C0250004R001</b>	C0250005R001	<b>C0250006R001</b>
C032	32		C0320001R001	<b>C0320002R001</b>	C0320003R001	<b>C0320004R001</b>	C0320005R001	<b>C0320006R001</b>
C040	40	90°	C0400001R001	<b>C0400002R001</b>	C0400003R001	<b>C0400004R001</b>	C0400005R001	<b>C0400006R001</b>
P012	12	<input type="checkbox"/> 48 <input type="checkbox"/>	P0120001R001-1	<b>P0120002R001-1</b>	P0120003R001-1	<b>P0120004R001-1</b>	P0120005R001-1	<b>P0120006R001-1</b>
P016	16		P0160001R001-1	<b>P0160002R001-1</b>	P0160003R001-1	<b>P0160004R001-1</b>	P0160005R001-1	<b>P0160006R001-1</b>
P020	20		P0200001R001-1	<b>P0200002R001-1</b>	P0200003R001-1	<b>P0200004R001-1</b>	P0200005R001-1	<b>P0200006R001-1</b>
C025	25		C0250001R001-1	<b>C0250002R001-1</b>	C0250003R001-1	<b>C0250004R001-1</b>	C0250005R001-1	<b>C0250006R001-1</b>
C032	32		C0320001R001-1	<b>C0320002R001-1</b>	C0320003R001-1	<b>C0320004R001-1</b>	C0320005R001-1	<b>C0320006R001-1</b>
C040	40	90°	C0400001R001-1	<b>C0400002R001-1</b>	C0400003R001-1	<b>C0400004R001-1</b>	C0400005R001-1	<b>C0400006R001-1</b>
P012	12	<input type="checkbox"/> 64 <input type="checkbox"/>	P0120001R007	<b>P0120002R007</b>	P0120003R007	<b>P0120004R007</b>	P0120005R007	<b>P0120006R007</b>
P016	16		P0160001R007	<b>P0160002R007</b>	P0160003R007	<b>P0160004R007</b>	P0160005R007	<b>P0160006R007</b>
P020	20		P0200001R007	<b>P0200002R007</b>	P0200003R007	<b>P0200004R007</b>	P0200005R007	<b>P0200006R007</b>
C025	25		C0250001R007	<b>C0250002R007</b>	C0250003R007	<b>C0250004R007</b>	C0250005R007	<b>C0250006R007</b>
C032	32		C0320001R007	<b>C0320002R007</b>	C0320003R007	<b>C0320004R007</b>	C0320005R007	<b>C0320006R007</b>
C040	40	90°	C0400001R007	<b>C0400002R007</b>	C0400003R007	<b>C0400004R007</b>	C0400005R007	<b>C0400006R007</b>
P012	12	<input type="checkbox"/> 64 <input type="checkbox"/>	P0120001R007-1	<b>P0120002R007-1</b>	P0120003R007-1	<b>P0120004R007-1</b>	P0120005R007-1	<b>P0120006R007-1</b>
P016	16		P0160001R007-1	<b>P0160002R007-1</b>	P0160003R007-1	<b>P0160004R007-1</b>	P0160005R007-1	<b>P0160006R007-1</b>
P020	20		P0200001R007-1	<b>P0200002R007-1</b>	P0200003R007-1	<b>P0200004R007-1</b>	P0200005R007-1	<b>P0200006R007-1</b>
C025	25		C0250001R007-1	<b>C0250002R007-1</b>	C0250003R007-1	<b>C0250004R007-1</b>	C0250005R007-1	<b>C0250006R007-1</b>
C032	32		C0320001R007-1	<b>C0320002R007-1</b>	C0320003R007-1	<b>C0320004R007-1</b>	C0320005R007-1	<b>C0320006R007-1</b>
C040	40	90°	C0400001R007-1	<b>C0400002R007-1</b>	C0400003R007-1	<b>C0400004R007-1</b>	C0400005R007-1	<b>C0400006R007-1</b>

SERIES	NOM. CURRENT AC21A AMP.	MARKING	3-POLE RETRACTIVE 3 WAFERS
P012	12	<input type="checkbox"/> 48 <input type="checkbox"/>	P0120007R001
P016	16		P0160007R001
P020	20		P0200007R001
C025	25		C0250007R001
C032	32		C0320007R001
C040	40	45°	C0400007R001
P012	12	<input type="checkbox"/> 64 <input type="checkbox"/>	P0120007R007
P016	16		P0160007R007
P020	20		P0200007R007
C025	25		C0250007R007
C032	32		C0320007R007
C040	40	45°	C0400007R007

### NOTE:

The C012, C016, C020 series can be supplied upon request. To make your order replace the letter "P" in the reference numbers of the P012, P016, P020 series respectively with the letter "C": P0120001R001 becomes C0120001R001.

These series are not available in the O56-O62 operator versions. For the O27 operator replace the reference with "015": P0160003R027 becomes C0160003R015

# Phoenix

## Control switches

### Panel mounting



Red knob  
**002**  48  
**008**  64

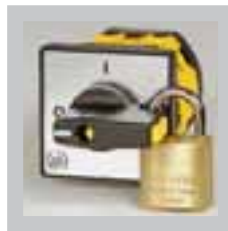

Black knob  
 with locking facility  
**003**

Red knob  
 with locking facility  
**004**



SERIES	NOM. CURRENT AC21A AMP.	MARKING	3-POLE 2 WAFERS		MARKING	3-POLE 2 WAFERS		4-POLE 2 WAFERS	
PO12	12	<input type="checkbox"/> 48	PO120003R002	PO120004R002	<input type="checkbox"/> 48	PO120003R003	PO120004R003	PO120003R003	PO120004R003
PO16	16		PO160003R002	PO160004R002		PO160003R003	PO160004R003	PO160003R003	PO160004R003
PO20	20		PO200003R002	PO200004R002		PO200003R003	PO200004R003	PO200003R003	PO200004R003
CO25	25		CO250003R002	CO250004R002		CO250003R003	CO250004R003	CO250003R003	CO250004R003
CO32	32		CO320003R002	CO320004R002		CO320003R003	CO320004R003	CO320003R003	CO320004R003
CO40	40	90°	CO400003R002	CO400004R002	90°	CO400003R003	CO400004R003	CO400003R003	CO400004R003
PO12	12	<input type="checkbox"/> 64	PO120003R008	PO120004R008	<input type="checkbox"/> 48	PO120003R004	PO120004R004	PO120003R004	PO120004R004
PO16	16		PO160003R008	PO160004R008		PO160003R004	PO160004R004	PO160003R004	PO160004R004
PO20	20		PO200003R008	PO200004R008		PO200003R004	PO200004R004	PO200003R004	PO200004R004
CO25	25		CO250003R008	CO250004R008		CO250003R004	CO250004R004	CO250003R004	CO250004R004
CO32	32		CO320003R008	CO320004R008		CO320003R004	CO320004R004	CO320003R004	CO320004R004
CO40	40	90°	CO400003R008	CO400004R008	90°	CO400003R004	CO400004R004	CO400003R004	CO400004R004



Grey escutcheon,  
 black disc-type knob  
 with locking facility for 3 padlocks  
**009**

Yellow escutcheon,  
 red disc-type knob  
 with locking facility for 3 padlocks

**010**



SERIES	NOM. CURRENT AC21A AMP.	MARKING	3-POLE 2 WAFERS		MARKING	3-POLE 2 WAFERS		4-POLE 2 WAFERS	
PO12	12	<input type="checkbox"/> 67	PO120003R009	PO120004R009	<input type="checkbox"/> 67	PO120003R010	PO120004R010	PO120003R010	PO120004R010
PO16	16		PO160003R009	PO160004R009		PO160003R010	PO160004R010	PO160003R010	PO160004R010
PO20	20		PO200003R009	PO200004R009		PO200003R010	PO200004R010	PO200003R010	PO200004R010
CO25	25		CO250003R009	CO250004R009		CO250003R010	CO250004R010	CO250003R010	CO250004R010
CO32	32		CO320003R009	CO320004R009		CO320003R010	CO320004R010	CO320003R010	CO320004R010
CO40	40	90°	CO400003R009	CO400004R009	90°	CO400003R010	CO400004R010	CO400003R010	CO400004R010
PO12	12	<input type="checkbox"/> 67	PO120003R009-1	PO120004R009-1	<input type="checkbox"/> 67	PO120003R010-1	PO120004R010-1	PO120003R010-1	PO120004R010-1
PO16	16		PO160003R009-1	PO160004R009-1		PO160003R010-1	PO160004R010-1	PO160003R010-1	PO160004R010-1
PO20	20		PO200003R009-1	PO200004R009-1		PO200003R010-1	PO200004R010-1	PO200003R010-1	PO200004R010-1
CO25	25		CO250003R009-1	CO250004R009-1		CO250003R010-1	CO250004R010-1	CO250003R010-1	CO250004R010-1
CO32	32		CO320003R009-1	CO320004R009-1		CO320003R010-1	CO320004R010-1	CO320003R010-1	CO320004R010-1
CO40	40	90°	CO400003R009-1	CO400004R009-1	90°	CO400003R010-1	CO400004R010-1	CO400003R010-1	CO400004R010-1

# Phoenix

## Control switches

Panel mounting



TECHNO-CONTROL EQUIPMENT



Round  
escutcheon  
**013**  $\varnothing$  59  
**014**  $\varnothing$  52

SERIES	NOM. CURRENT AC21A AMP.	MARKING	1-POLE 1 WAFER	2-POLE 1 WAFER	3-POLE 2 WAFERS	4-POLE 2 WAFERS	5-POLE 3 WAFERS
P012	12	$\varnothing$ 59 	P0120001R013	P0120002R013	P0120003R013	P0120004R013	P0120005R013
P016	16		P0160001R013	P0160002R013	P0160003R013	P0160004R013	P0160005R013
P020	20	90° 	P0200001R013	P0200002R013	P0200003R013	P0200004R013	P0200005R013
P012	12	$\varnothing$ 52 	P0120001R014	P0120002R014	P0120003R014	P0120004R014	P0120005R014
P016	16		P0160001R014	P0160002R014	P0160003R014	P0160004R014	P0160005R014
P020	20	90° 	P0200001R014	P0200002R014	P0200003R014	P0200004R014	P0200005R014



Round  
escutcheon  
**013**  $\varnothing$  59  
**014**  $\varnothing$  52

SERIES	NOM. CURRENT AC21A AMP.	MARKING	6-POLE 3 WAFERS	MARKING	3-POLE RETRACTIVE 2 WAFERS
P012	12	$\varnothing$ 59 	P0120006R013	$\varnothing$ 59 	P0120007R013
P016	16		P0160006R013		P0160007R013
P020	20	90° 	P0200006R013	45° 	P0200007R013
P012	12	$\varnothing$ 52 	P0120006R014	$\varnothing$ 52 	P0120007R014
P016	16		P0160006R014		P0160007R014
P020	20	90° 	P0200006R014	45° 	P0200007R014



# Phoenix

## Control switches

Panel mounting

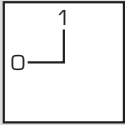

Black knob only  
018  
040

SERIES	NOM. CURRENT AC21A AMP.	POSITIONS	1-POLE 1 WAFER	2-POLE 1 WAFER	3-POLE 2 WAFERS	4-POLE 2 WAFERS	5-POLE 3 WAFERS
P012	12	 90°	P0120001R018	P0120002R018	P0120003R018	P0120004R018	P0120005R018
P016	16		P0160001R018	P0160002R018	P0160003R018	P0160004R018	P0160005R018
P020	20		P0200001R018	P0200002R018	P0200003R018	P0200004R018	P0200005R018
C025	25		C0250001R040	C0250002R040	C0250003R040	C0250004R040	C0250005R040
C032	32		C0320001R040	C0320002R040	C0320003R040	C0320004R040	C0320005R040
C040	40		C0400001R040	C0400002R040	C0400003R040	C0400004R040	C0400005R040

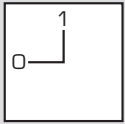
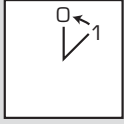
SERIES	NOM. CURRENT AC21A AMP.	POSITIONS	6-POLE 3 WAFERS	POSITIONS	3-POLE RETRACTIVE 2 WAFERS
P012	12	 90°	P0120006R018	 45°	P0120007R018
P016	16		P0160006R018		P0160007R018
P020	20		P0200006R018		P0200007R018
C025	25		C0250006R040		C0250007R040
C032	32		C0320006R040		C0320007R040
C040	40		C0400006R040		C0400007R040

# Phoenix

## Control switches

Panel mounting – Ø 22.5 hole



TECHNO-CONTROL EQUIPMENT



Central fixing Ø 22  
with knob  
**028**



Central fixing Ø 22  
with key  
**029**

SERIES	NOM. CURRENT AC21A AMP.	POSITIONS	1-POLE 1 WAFER	2-POLE 1 WAFER	3-POLE 2 WAFERS	4-POLE 2 WAFERS
PO12	12	 90°	PO120001R028	<b>PO120002R028</b>	PO120003R028	PO120004R028
PO16	16		PO160001R028	<b>PO160002R028</b>	PO160003R028	PO160004R028
PO20	20		PO200001R028	<b>PO200002R028</b>	PO200003R028	PO200004R028
PO12	12		PO120001R029	<b>PO120002R029</b>	PO120003R029	PO120004R029
PO16	16		PO160001R029	<b>PO160002R029</b>	PO160003R029	PO160004R029
PO20	20		PO200001R029	<b>PO200002R029</b>	PO200003R029	PO200004R029



Central fixing Ø 22  
□ 48  
with black knob  
**056 056-1**

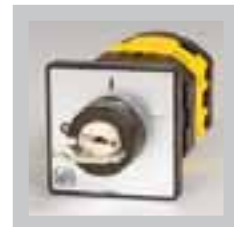

Central fixing Ø 22  
□ 48  
with key  
**057 057-1**

SERIES	NOM. CURRENT AC21A AMP.	MARKING	1-POLE 1 WAFER	2-POLE 1 WAFER	3-POLE 2 WAFERS	4-POLE 2 WAFERS	5-POLE 3 WAFERS	6-POLE 3 WAFERS
PO12	12	 90°	PO120001R056	<b>PO120002R056</b>	PO120003R056	<b>PO120004R056</b>	PO120005R056	<b>PO120006R056</b>
PO16	16		PO160001R056	<b>PO160002R056</b>	PO160003R056	<b>PO160004R056</b>	PO160005R056	<b>PO160006R056</b>
PO20	20		PO200001R056	<b>PO200002R056</b>	PO200003R056	<b>PO200004R056</b>	PO200005R056	<b>PO200006R056</b>
PO12	12		PO120001R057	<b>PO120002R057</b>	PO120003R057	<b>PO120004R057</b>	PO120005R057	<b>PO120006R057</b>
PO16	16		PO160001R057	<b>PO160002R057</b>	PO160003R057	<b>PO160004R057</b>	PO160005R057	<b>PO160006R057</b>
PO20	20		PO200001R057	<b>PO200002R057</b>	PO200003R057	<b>PO200004R057</b>	PO200005R057	<b>PO200006R057</b>
PO12	12	 90°	PO120001R056-1	<b>PO120002R056-1</b>	PO120003R056-1	<b>PO120004R056-1</b>	PO120005R056-1	<b>PO120006R056-1</b>
PO16	16		PO160001R056-1	<b>PO160002R056-1</b>	PO160003R056-1	<b>PO160004R056-1</b>	PO160005R056-1	<b>PO160006R056-1</b>
PO20	20		PO200001R056-1	<b>PO200002R056-1</b>	PO200003R056-1	<b>PO200004R056-1</b>	PO200005R056-1	<b>PO200006R056-1</b>
PO12	12		PO120001R057-1	<b>PO120002R057-1</b>	PO120003R057-1	<b>PO120004R057-1</b>	PO120005R057-1	<b>PO120006R057-1</b>
PO16	16		PO160001R057-1	<b>PO160002R057-1</b>	PO160003R057-1	<b>PO160004R057-1</b>	PO160005R057-1	<b>PO160006R057-1</b>
PO20	20		PO200001R057-1	<b>PO200002R057-1</b>	PO200003R057-1	<b>PO200004R057-1</b>	PO200005R057-1	<b>PO200006R057-1</b>

• Key removal position

# Phoenix

## Control switches

Panel mounting – Ø 22.5 hole







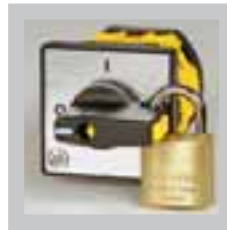



Central fixing Ø 22  
□48  
with red knob  
**058 058-1**

Central fixing Ø 22  
with black knob  
and locking facility  
**059**

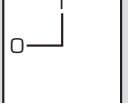
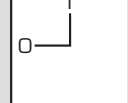
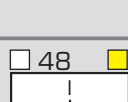

Central fixing Ø 22  
with red knob  
and locking facility  
**060**

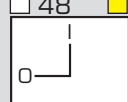







SERIES	NOM. CURRENT AC21A AMP.	MARKING	3-POLE 2 WAFERS	4-POLE 2 WAFERS	MARKING	3-POLE 2 WAFERS	4-POLE 2 WAFERS
P012	12	□ 48 	P0120003R058	P0120004R058	□ 48 	P0120003R059	P0120004R059
P016	16		P0160003R058	P0160004R058		P0160003R059	P0160004R059
P020	20	90°	P0200003R058	P0200004R058		P0200003R059	P0200004R059
P012	12	□ 48 	P0120003R058-1	P0120004R058-1	□ 48 	P0120003R060	P0120004R060
P016	16		P0160003R058-1	P0160004R058-1		P0160003R060	P0160004R060
P020	20	90°	P0200003R058-1	P0200004R058-1		P0200003R060	P0200004R060

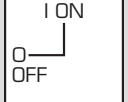

Central fixing Ø 22  
grey escutcheon,  
black disc-type knob  
with locking facility  
for 3 padlocks  
**061 061-1**

Central fixing Ø 22  
yellow escutcheon,  
red disc-type knob  
with locking facility  
for 3 padlocks  
**062 062-1**

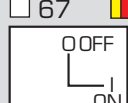

SERIES	NOM. CURRENT AC21A AMP.	MARKING	3-POLE 2 WAFERS	4-POLE 2 WAFERS	MARKING	3-POLE 2 WAFERS	4-POLE 2 WAFERS
P012	12	□ 67 	P0120003R061	P0120004R061	□ 67 	P0120003R062	P0120004R062
P016	16		P0160003R061	P0160004R061		P0160003R062	P0160004R062
P020	20	90°	P0200003R061	P0200004R061	90°	P0200003R062	P0200004R062
P012	12	□ 67 	P0120003R061-1	P0120004R061-1	□ 67 	P0120003R062-1	P0120004R062-1
P016	16		P0160003R061-1	P0160004R061-1		P0160003R062-1	P0160004R062-1
P020	20	90°	P0200003R061-1	P0200004R061-1	90°	P0200003R062-1	P0200004R062-1

# Phoenix

## Control switches

Base-DIN rail mounting



TECHNO-CONTROL EQUIPMENT



Door interlock knob with locking facility **005**



Red door interlock knob with locking facility **006**

SERIES	MARKING	3-POLE	4-POLE	MARKING	3-POLE	4-POLE
		2 WAFERS	2 WAFERS		2 WAFERS	2 WAFERS
PO12	□ 48 ■ 	PO120003B005	PO120004B005	□ 48 ■ 	PO120003B006	PO120004B006
PO16		PO160003B005	PO160004B005		PO160003B006	PO160004B006
PO20	90°	PO200003B005	PO200004B005	90°	PO200003B006	PO200004B006



Door interlock grey escutcheon, black disc-type knob with locking facility for 3 padlocks **011 011-A**



Door interlock yellow escutcheon, red disc-type knob with locking facility for 3 padlocks **012 012-2**

SERIES	MARKING	3-POLE	4-POLE	MARKING	3-POLE	4-POLE
		2 WAFERS	2 WAFERS		2 WAFERS	2 WAFERS
PO12	□ 67 ■ 	PO120003B011	PO120004B011	□ 67 ■ 	PO120003B012	PO120004B012
PO16		PO160003B011	PO160004B011		PO160003B012	PO160004B012
PO20	90°	PO200003B011	PO200004B011	90°	PO200003B012	PO200004B012
PO12	□ 67 ■ 	PO120003B011-A	PO120004B011-A	□ 67 ■ 	PO120003B012-2	PO120004B012-2
PO16		PO160003B011-A	PO160004B011-A		PO160003B012-2	PO160004B012-2
PO20	90°	PO200003B011-A	PO200004B011-A	90°	PO200003B012-2	PO200004B012-2

# Phoenix

## Control switches

Base-DIN rail mounting



Installation in 46mm  
standardised enclosures  
black knob  
**027**

SERIES	MARKING	1-POLE	2-POLE	3-POLE	4-POLE	5-POLE	6-POLE
		3 WAFERS	3 WAFERS	3 WAFERS	3 WAFERS	3 WAFERS	3 WAFERS
P012	□ 52,5X45 0	P0120001D027	P0120002D027	P0120003D027	P0120004D027	P0120005D027	P0120006D027
P016	□ 90°	P0160001D027	P0160002D027	P0160003D027	P0160004D027	P0160005D027	P0160006D027

### Base-DIN rail mounting with central fixing Ø 22



Door interlock  
central fixing Ø 22  
grey escutcheon,  
black disc-type knob  
**063 063-1**



Door interlock  
central fixing Ø 22  
yellow escutcheon,  
red disc-type knob  
**064 064-1**

SERIES	MARKING	3-POLE	4-POLE	MARKING	3-POLE	4-POLE
		2 WAFERS	2 WAFERS		2 WAFERS	2 WAFERS
P012	■	P0120003B063	P0120004B063	■	P0120003B063-1	P0120004B063-1
P016	063	P0160003B063	P0160004B063	063-1	P0160003B063-1	P0160004B063-1
P020	□ 67 ON OFF	P0200003B063	P0200004B063	□ 67 OFF ON	P0200003B063-1	P0200004B063-1
P012	■	P0120003B064	P0120004B064	■	P0120003B064-1	P0120004B064-1
P016	064	P0160003B064	P0160004B064	064-1	P0160003B064-1	P0160004B064-1
P020	90°	P0200003B064	P0200004B064	90°	P0200003B064-1	P0200004B064-1

# Phoenix

## Line changeover switches

Panel and Ø 22.5 hole mounting



TECHNO-CONTROL EQUIPMENT



Standard control knob

001 □ 48

007 □ 64



Central fixing Ø 22 black knob

□ 48 056

SERIES	NOM. CURRENT AC21A AMP.	MARKING	1-POLE	2-POLE	3-POLE	4-POLE
			1 WAFER	2 WAFERS	3 WAFERS	4 WAFERS
P012	12		P0120008R001	<b>P0120009R001</b>	P0120010R001	P0120011R001
P016	16		P0160008R001	<b>P0160009R001</b>	P0160010R001	P0160011R001
P020	20		P0200008R001	<b>P0200009R001</b>	P0200010R001	P0200011R001
C025	25		C0250008R001	<b>C0250009R001</b>	C0250010R001	C0250011R001
C032	32		C0320008R001	<b>C0320009R001</b>	C0320010R001	C0320011R001
C040	40		C0400008R001	<b>C0400009R001</b>	C0400010R001	C0400011R001
P012	12		P0120008R056	<b>P0120009R056</b>	P0120010R056	P0120011R056
P016	16		P0160008R056	<b>P0160009R056</b>	P0160010R056	P0160011R056
P020	20	P0200008R056	<b>P0200009R056</b>	P0200010R056	P0200011R056	
P012	12		P0120008R007	<b>P0120009R007</b>	P0120010R007	P0120011R007
P016	16		P0160008R007	<b>P0160009R007</b>	P0160010R007	P0160011R007
P020	20		P0200008R007	<b>P0200009R007</b>	P0200010R007	P0200011R007
C025	25		C0250008R007	<b>C0250009R007</b>	C0250010R007	C0250011R007
C032	32		C0320008R007	<b>C0320009R007</b>	C0320010R007	C0320011R007
C040	40		C0400008R007	<b>C0400009R007</b>	C0400010R007	C0400011R007



Round escutcheon

013 ø 59

014 ø 52



Black knob only

018

040

SERIES	NOM. CURRENT AC21A AMP.	MARKING	1-POLE	2-POLE	3-POLE	4-POLE
			1 WAFER	2 WAFERS	3 WAFERS	4 WAFERS
P012	12		P0120008R013	<b>P0120009R013</b>	P0120010R013	P0120011R013
P016	16		P0160008R013	<b>P0160009R013</b>	P0160010R013	P0160011R013
P020	20		P0200008R013	<b>P0200009R013</b>	P0200010R013	P0200011R013
P012	12		P0120008R014	<b>P0120009R014</b>	P0120010R014	P0120011R014
P016	16		P0160008R014	<b>P0160009R014</b>	P0160010R014	P0160011R014
P020	20		P0200008R014	<b>P0200009R014</b>	P0200010R014	P0200011R014
P012	12		P0120008R018	<b>P0120009R018</b>	P0120010R018	P0120011R018
P016	16		P0160008R018	<b>P0160009R018</b>	P0160010R018	P0160011R018
P020	20	P0200008R018	<b>P0200009R018</b>	P0200010R018	P0200011R018	
C025	25		C0250008R040	<b>C0250009R040</b>	C0250010R040	C0250011R040
C032	32		C0320008R040	<b>C0320009R040</b>	C0320010R040	C0320011R040
C040	40		C0400008R040	<b>C0400009R040</b>	C0400010R040	C0400011R040

# Phoenix

## Motor changeover switches

Panel and Ø 22.5 hole mounting



Standard control knob

001 □ 48

007 □ 64



Central fixing Ø 22 black knob

056 □ 48

### REVERSING SWITCHES

SERIES	NOM. CURRENT AC21A AMP.	MARKING	MARKING				
			3-POLE 3 WAFERS	3-POLE RETRACTIVE 3 WAFERS	FOR SINGLE-PHASE MOTORS WITH CENTRIFUGAL CUT-OUT 3 WAFERS	FOR SINGLE-PHASE MOTORS WITH AUXILIARY PHASE 3 WAFERS	
			45°	45°	45°	45°	
P012	12	001 □ 48	PO120012R001	PO120013R001	PO120016R001	PO120018R001	
P016	16		PO160012R001	PO160013R001	PO160016R001	PO160018R001	
P020	20		PO200012R001	PO200013R001	PO200016R001	PO200018R001	
C025	25		CO250012R001	CO250013R001	CO250016R001	CO250018R001	
C032	32		CO320012R001	CO320013R001	CO320016R001	CO320018R001	
C040	40		CO400012R001	CO400013R001	CO400016R001	CO400018R001	
P012	12		056	PO120012R056	PO120013R056	PO120016R056	PO120018R056
P016	16			PO160012R056	PO160013R056	PO160016R056	PO160018R056
P020	20			PO200012R056	PO200013R056	PO200016R056	PO200018R056
P012	12			007 □ 64	PO120012R007	PO120013R007	PO120016R007
P016	16	PO160012R007			PO160013R007	PO160016R007	PO160018R007
P020	20	PO200012R007			PO200013R007	PO200016R007	PO200018R007
C025	25	CO250012R007			CO250013R007	CO250016R007	CO250018R007
C032	32	CO320012R007			CO320013R007	CO320016R007	CO320018R007
C040	40	CO400012R007			CO400013R007	CO400016R007	CO400018R007

# Phoenix

## Motor changeover switches

Panel and Ø 22.5 hole mounting



TECHNO-CONTROL EQUIPMENT



Standard control knob

001 □ 48

007 □ 64



Central fixing Ø 22 black knob

056 □ 48

### 2-SPEED SWITCH

### STAR DELTA SWITCH

### SWITCH

3-POLE DAHLANDER  
4 WAFERS

4 WAFERS

FOR SINGLE-PHASE MOTORS WITH AUXILIARY PHASE  
2 WAFERS

MARKING

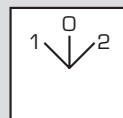

45°

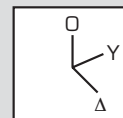

60°

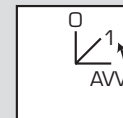

45°

SERIES	NOM. CURRENT AC21A AMP.	MARKING	MARKING	2-SPEED SWITCH	STAR DELTA SWITCH	SWITCH	
P012	12	<div style="display: flex; align-items: center; justify-content: center;"> <div style="border: 1px solid black; width: 40px; height: 40px; margin-right: 5px;"></div> <div style="text-align: center;"> <p>001</p> <p>□ 48</p> </div> </div>		P0120014R001	P0120015R001	P0120017R001	
P016	16			P0160014R001	P0160015R001	P0160017R001	
P020	20			P0200014R001	P0200015R001	P0200017R001	
C025	25			C0250014R001	C0250015R001	C0250017R001	
C032	32			C0320014R001	C0320015R001	C0320017R001	
C040	40			C0400014R001	C0400015R001	C0400017R001	
P012	12		<div style="display: flex; align-items: center; justify-content: center;"> <div style="border: 1px solid black; width: 40px; height: 40px; margin-right: 5px;"></div> <div style="text-align: center;"> <p>056</p> <p>□ 48</p> </div> </div>		P0120014R056	P0120015R056	P0120017R056
P016	16				P0160014R056	P0160015R056	P0160017R056
P020	20				P0200014R056	P0200015R056	P0200017R056
P012	12				P0120014R007	P0120015R007	P0120017R007
P016	16			P0160014R007	P0160015R007	P0160017R007	
P020	20			P0200014R007	P0200015R007	P0200017R007	
C025	25			C0250014R007	C0250015R007	C0250017R007	
C032	32			C0320014R007	C0320015R007	C0320017R007	
C040	40			C0400014R007	C0400015R007	C0400017R007	



# Phoenix

## Motor changeover switches

Panel mounting





Round  
escutcheon  
**013** ø 59  
**014** ø 52



Black  
knob only  
**018**  
**040**

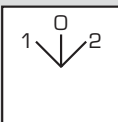
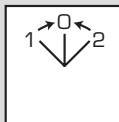
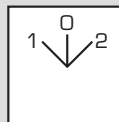
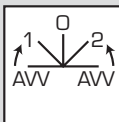

### REVERSING SWITCHES

SERIES	NOM. CURRENT AC21A AMP.	MARKING	MARKING	3-POLE 3 WAFERS	3-POLE RETRACTIVE 3 WAFERS	FOR SINGLE-PHASE MOTORS WITH CENTRIFUGAL CUT-OUT 3 WAFERS	FOR SINGLE-PHASE MOTORS WITH AUXILIARY PHASE 3 WAFERS
				 45°	 45°	 45°	 45°
PO12	12		013	PO120012R013	PO120013R013	PO120016R013	PO120018R013
PO16	16			PO160012R013	PO160013R013	PO160016R013	PO160018R013
PO20	20			PO200012R013	PO200013R013	PO200016R013	PO200018R013
PO12	12			014	PO120012R014	PO120013R014	PO120016R014
PO16	16	018	018	PO160012R014	PO160013R014	PO160016R014	PO160018R014
PO20	20			PO200012R014	PO200013R014	PO200016R014	PO200018R014
PO12	12			PO120012R018	PO120013R018	PO120016R018	PO120018R018
PO16	16			PO160012R018	PO160013R018	PO160016R018	PO160018R018
PO20	20	040	040	PO200012R018	PO200013R018	PO200016R018	PO200018R018
CO25	25			CO250012R040	CO250013R040	CO250016R040	CO250018R040
CO32	32			CO320012R040	CO320013R040	CO320016R040	CO320018R040
CO40	40			CO400012R040	CO400013R040	CO400016R040	CO400018R040

### 2-SPEED SWITCH

### STAR DELTA SWITCH

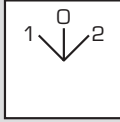
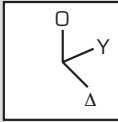
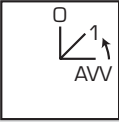
### SWITCH

SERIES	NOM. CURRENT AC21A AMP.	MARKING	MARKING	3-POLE DAHLANDER 4 WAFERS	4 WAFERS	FOR SINGLE-PHASE MOTORS WITH AUXILIARY PHASE 2 WAFERS
				 45°	 60°	 45°
PO12	12		013	PO120014R013	PO120015R013	PO120017R013
PO16	16			PO160014R013	PO160015R013	PO160017R013
PO20	20			PO200014R013	PO200015R013	PO200017R013
PO12	12			014	PO120014R014	PO120015R014
PO16	16	018	018	PO160014R014	PO160015R014	PO160017R014
PO20	20			PO200014R014	PO200015R014	PO200017R014
PO12	12			PO120014R018	PO120015R018	PO120017R018
PO16	16			PO160014R018	PO160015R018	PO160017R018
PO20	20	040	040	PO200014R018	PO200015R018	PO200017R018
CO25	25			CO250014R040	CO250015R040	CO250017R040
CO32	32			CO320014R040	CO320015R040	CO320017R040
CO40	40			CO400014R040	CO400015R040	CO400017R040

# Phoenix

Instrumentation switches - Changeover without off switches - Step switches  
Panel and Ø 22.5 hole mounting



TECHNO-CONTROL EQUIPMENT



Standard control knob  
001  48  
007  64



Central fixing Ø 22 black knob  
056  48

SERIES	NOM. CURRENT AC21A AMP.	MARKING	MARKING			
			AMMETER 1-POLE FOR 3 CTS 3 WAFERS	3-PHASE TO NEUTRAL 2 WAFERS	VOLTMETER PHASE TO PHASE 2 WAFERS	PHASE TO PHASE 2 CIRCUITS 4 WAFERS
			90°	45°	45°	45°
PO12	12		PO120019R001	PO120020R001	PO120021R001	PO120022R001
PO16	16		PO160019R001	PO160020R001	PO160021R001	PO160022R001
PO20	20		PO200019R001	PO200020R001	PO200021R001	PO200022R001
PO12	12		PO120019R056	PO120020R056	PO120021R056	PO120022R056
PO16	16		PO160019R056	PO160020R056	PO160021R056	PO160022R056
PO20	20		PO200019R056	PO200020R056	PO200021R056	PO200022R056
PO12	12		PO120019R007	PO120020R007	PO120021R007	PO120022R007
PO16	16		PO160019R007	PO160020R007	PO160021R007	PO160022R007
PO20	20		PO200019R007	PO200020R007	PO200021R007	PO200022R007

SERIES	NOM. CURRENT AC21A AMP.	MARKING	MARKING				
			VOLTMETER PHASE TO PHASE PHASE TO NEUTRAL 3 WAFERS	PHASE TO PHASE - 1 PHASE TO NEUTRAL 3 WAFERS	SINGLE POLE 1 WAFER	DOUBLE POLE 2 WAFERS	3-POLE 3 WAFERS
			45°	45°			
PO12	12		PO120023R001	PO120024R001	PO120025R001	PO120026R001	PO120027R001
PO16	16		PO160023R001	PO160024R001	PO160025R001	PO160026R001	PO160027R001
PO20	20		PO200023R001	PO200024R001	PO200025R001	PO200026R001	PO200027R001
PO12	12		PO120023R056	PO120024R056	PO120025R056	PO120026R056	PO120027R056
PO16	16		PO160023R056	PO160024R056	PO160025R056	PO160026R056	PO160027R056
PO20	20		PO200023R056	PO200024R056	PO200025R056	PO200026R056	PO200027R056
PO12	12		PO120023R007	PO120024R007	PO120025R007	PO120026R007	PO120027R007
PO16	16		PO160023R007	PO160024R007	PO160025R007	PO160026R007	PO160027R007
PO20	20		PO200023R007	PO200024R007	PO200025R007	PO200026R007	PO200027R007

# Phoenix

**Step switches** - Panel and Ø 22.5 hole mounting  
**Instrumentation switches** - Base-DIN rail mounting

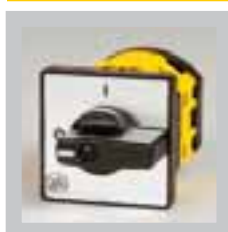

Standard control knob  
 Black knob

001 □ 48  
 007 □ 64



Central fixing Ø 22  
 black knob

056 □ 48

Installation in standard  
 46mm standardised  
 enclosures black knob  
**027**



## STEP WITH OFF SWITCH

SERIES	NOM. CURRENT AC21A AMP.	MARKING	MARKING	STEP WITH OFF SWITCH		
				2-STEP SINGLE POLE 1 WAFER	3-STEP SINGLE POLE 2 WAFERS	4-STEP SINGLE POLE 2 WAFERS
PO12	12		001	PO120028R001	<b>PO120029R001</b>	PO120030R001
PO16	16			PO160028R001	<b>PO160029R001</b>	PO160030R001
PO20	20			PO200028R001	<b>PO200029R001</b>	PO200030R001
PO12	12			PO120028R056	<b>PO120029R056</b>	PO120030R056
PO16	16			PO160028R056	<b>PO160029R056</b>	PO160030R056
PO20	20			PO200028R056	<b>PO200029R056</b>	PO200030R056
PO12	12			PO120028R007	<b>PO120029R007</b>	PO120030R007
PO16	16			PO160028R007	<b>PO160029R007</b>	PO160030R007
PO20	20			PO200028R007	<b>PO200029R007</b>	PO200030R007

## AMMETER

1-POLE  
 FOR 3 CTS  
 3 WAFERS

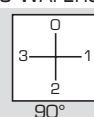

## VOLTMETER

PHASE  
 TO PHASE  
 3 WAFERS

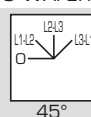

PHASE TO PHASE-PHASE  
 TO NEUTRAL  
 3 WAFERS

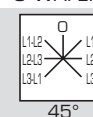

SERIES	NOM. CURRENT AC21A AMP.	MARKING	MARKING	AMMETER	VOLTMETER	VOLTMETER
				1-POLE FOR 3 CTS 3 WAFERS	PHASE TO PHASE 3 WAFERS	PHASE TO PHASE-PHASE TO NEUTRAL 3 WAFERS
PO12	12	52,5X45	001	PO120019D027	<b>PO120021D027</b>	PO120023D027
PO16	16			PO160019D027	<b>PO160021D027</b>	PO160023D027

## MADE TO ORDER SWITCHES



CX25 - CX32 - CX40 series  
 Made from the C25 - C32 - C40 series  
 With IP10 terminals  
 For multiple connections

PO12 - PO16 - PO20 series  
 with flat fast on terminals  
 No. 1 6.3x0.8 terminal  
 No. 2 2.8x0.8 terminal



# Phoenix

## Cam switches

### Accessories



TECHNO-CONTROL EQUIPMENT



**BF1/2NGO**

Moulded wall-mounted enclosure for PO12-PO16-PO20 R series. Provision for the installation of the switch on the front

Max 3 wafers IP65  
Black box - RAL 7035  
grey front cover  
Dimensions 120x100x82 mm  
No. 8 knock-outs

Moulded wall-mounted enclosure for PO12-PO16-PO20 R series  
Provision for the installation of the switch on the side

For Ref. 018 controls  
Max 3 wafers IP65  
Black box - RAL 7035  
grey front cover  
Dimensions 120x100x82 mm  
No. 8 knock-outs



**BL1/ONGO**

SHORT HANDLE <input type="checkbox"/> 6	LONG HANDLE	PADLOCKABLE HANDLE	ROUND KNOB
---	-------------	--------------------	------------



REF. NO.	COLOUR	CAM	REF. NO.	COLOUR	REF. NO.	COLOUR	CAM	Ø	REF. NO.	COLOUR
20402023	Black	<input type="checkbox"/> 6	20402025	Black	20401090	Black	<input type="checkbox"/> 5 *	34	20402027	Black
		<input type="checkbox"/> 6	20402026	Red			<input type="checkbox"/> 6 *	34	20402020	Black
20402024	Red	<input type="checkbox"/> 6 *	20402172	Black	20401091	Red	<input type="checkbox"/> 5 *	40	20402171	Black
		<input type="checkbox"/> 6 *	20402173	Red			<input type="checkbox"/> 6 *	40	20402170	Black

IP65 SEAL	IP65 SEAL	SHAFT <input type="checkbox"/> 5	ROUND KNOB Ø 30
-----------	-----------	----------------------------------	-----------------

For control knob: 013-014-018

For control knob: 040

For door interlock

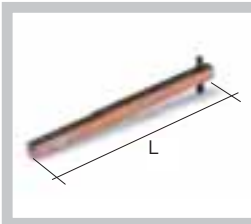

PO12-PO16-PO20 Series 28000012	CO25-CO32-CO40 Series 15000015	L 185 mm 20401089 L 300 mm 20401164	PO12-PO16 Series Control knob 015 20402050 Black
-----------------------------------	-----------------------------------	--	---

Ø 65 PROTECTION	Ø 65 PROTECTION ADAPTER	FLAT FAST ON TERMINALS
-----------------	-------------------------	------------------------



From 1 up to 3 wafers PO12 - PO16 - PO20 series 11706031	Dimensions = 2 wafers 11702038	PO12 - PO16 - PO20 Series FLAT 11708340 A 30° 11708341
---	-----------------------------------	---

\* Installation with adapter

# Phoenix

## Technical data

### Electrical characteristics

EN 60947-3 CHARACTERISTICS			P012	P016	P020	C025	C032	C040
Rated operating voltage U <sub>e</sub>	V		690	690	690	690	690	690
Rated insulation voltage U <sub>i</sub>	V		690	690	690	690	690	690
Rated impulse voltage U <sub>imp</sub>	kV		4	4	4	6	6	6
Rated thermal current I <sub>th</sub>	A		12	16	20	32	40	50
Rated thermal current enclosed I <sub>the</sub>	A		12	16	20	25	32	40
Frequency	Hz		50/60	50/60	50/60	50/60	50/60	50/60
<b>RATED OPERATING CURRENT I<sub>e</sub>: alternate current</b>								
AC-21A Switching resistive loads with light overloads	690V	A	12	16	20	25	32	40
AC-22A Switching mixed resistive and inductive loads with light overloads	690V	A	12	16	20	25	32	40
AC-23A Periodic switching of motors	Single-phase - 2-pole	110V A/kW	12/1,1	14/1,5	18/2	20/1,5	25/2,2	35/3
		230V A/kW	12/2,2	14/3	18/4	25/4	30/5,5	35/6,5
		230V A/kW	10/3	13/4	16/5	25/7,5	30/9	35/11
	3-phase - 3-pole	400V A/kW	10/5,5	13/7,5	16/9	22/11	27/15	32/18,5
		500V A/kW	10/7,5	14/10	16/11	22/15	27/18,5	32/22
		690V A/kW	10/7,5	14/10	16/12,5	16/15	20/18,5	25/22
AC3 Starting of cage motors (interruption while running)	Single-phase - 2-pole	110V A/kW	10/0,75	12/1,1	16/1,5	16/1,1	20/1,5	30/2,5
		230V A/kW	10/2	12/2,2	16/3,5	20/3,7	25/4	30/5,5
		230V A/kW	8/2,2	10/3	12/4	18/5,5	23/7,5	27/9
	3-phase - 3-pole	400V A/kW	8/4	10/5	10/6	16/7,5	20/11	27/15
		500V A/kW	8/5	10/7,5	12/8	16/11	20/15	27/18,5
		690V A/kW	6/5,5	8/7,5	10/9	12/11	16/15	20/18,5
<b>RATED OPERATING CURRENT I<sub>e</sub>: direct current</b>								
DC-21A Switching resistive loads with light overloads (1 phase)	50V (Single pole)	A	10	12	16	20*	25*	32*
DC-22A Switching mixed resistive and inductive loads with light overloads (1 phase)	30V (Single pole)	A	8	10	12	16*	20*	25*
AC-23A Periodic switching of motors (cosφ 0.45)	230V	A	128	128	128	280	280	280
	400V	A	128	128	128	256	256	256
	500V	A	128	128	128	256	256	256
	690V	A	128	128	128	200	200	200
Power dissipation for each phase	W		0,3*	0,35*	0,4*	-	-	-
<b>SHORT CIRCUIT CHARACTERISTICS</b>								
Rated short-time short circuit withstand current I <sub>cw</sub> (1s)	A		300	300	300	500	500	500
Rated short circuit making capacity I <sub>cm</sub>	A		1200	1200	1200	2840	2840	2840
Conditional rated short circuit withstand current	kA		5	5	5	10	10	10
Fuse rating gG	690V	A	20	20	20	40*	40*	40*
<b>UL 508 CHARACTERISTICS</b>								
General Use	600V ac	A	12	16	20	25	32	40
Standard motors load	Single-phase - 2-pole	120V ac HP(FLA)	0,5 (9,8)	1 (16)	1,5 (20)	1,5(20)	2 (24)	3 (34)
		240V ac HP(FLA)	1 (8)	1,5 (10)	2 (12)	3 (17)	5 (28)	5 (28)
		200V ac HP(FLA)	1,5 (9)	3 (14,4)	5 (22,8)	7,5 (25,3)	7,5 (25,3)	10 (32,2)
		240V ac HP(FLA)	3 (9,6)	5 (15,2)	5 (15,2)	7,5 (22)	7,5 (22)	10 (28)
	3-phase - 3-pole	480V ac HP(FLA)	5 (7,6)	7,5 (11)	10 (14)	15 (21)	20 (27)	20 (27)
		600V ac HP(FLA)	5 (6,1)	7,5 (9)	10 (11)	15 (17)	20 (22)	20 (22)

\*Values not reported on the IMQ file

\* Fuses gG 40A-500V

# Phoenix

## Technical data

### General characteristics



TECHNO-CONTROL EQUIPMENT

Comply with		IEC947-3, EN60947-3, UL508					
		P012 - P016 - P020			C025 - C032 - C040		
Protection class	controls	EN60529			IP65		
	controls O13 - O14 - O18 - O40				IP40		
	terminals				IP20		
	cx. series terminals				IP10		
Material group	EN60947-1			II			
Pollution grade	EN60947-1			3			
Flammability	UL 94			VO: live parts			
Ambient temperature				Operating: -25 +55			
				Storage: -30 +70			
Climate withstand	IEC68 part 2-3			Hot damp			
	IEC68 part 2-30			Unsettled hot damp			
Terminal referencing				EN50013			
Terminals:							
Dimension	EN60947-1			A3		A5	
Terminal screw				M 3,5		M4	
Torque	EN60947-1			0,8 Nm (7,2 lb. in.)		1,2 Nm (10,6 lb. in.)	
	UL508			7,5 lb. in. (0,85 Nm)		12 lb in. (1,4 Nm)	
Capacity:							
n° 2 flexible conductors min/max	mm <sup>2</sup>	1x0,75/4 - 2x0,75/2,5		2x2,5/10			
	AWG	16-12		14-6			
n° 2 solid conductors min/max	mm <sup>2</sup>	1x0,75/4 - 2x0,75/2,5		2X2,5/10			
	AWG	16-12		14-6			
Contacts				Double gap contacts with positive opening action			
Opening angles				45° - 60° - 90°		30° - 45° - 60° - 90°	
Mechanical life at 120 operations per hour	mil./cycles	1		1			
Electrical life at 120 operations per hour	AC21 mil./cycles	1	0,75	0,75	1	0,75 0,5	
CERTIFICATIONS		P012	P016	P020	C025	C032	C040
CE mark - Europe		■	■	■	■	■	■
CUL Listed - USA and Canada		●	●	●	●	●	●
Istituto Marchio Qualità (IMQ) - Italy		●	●	●	●	●	●
CCC China		●	●	●	●	●	●
GOST-R Russia		●	●	●	●	●	●

■ Meets or exceed the minimum requirements ● Certified

# Phoenix

## Dimensions

Fixing details

### PANEL MOUNTING

#### FIXING HOLES

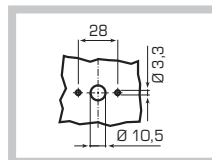

P012 - P016 - P020 SERIES

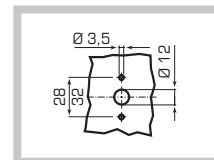

C012 - C016 - C020 SERIES

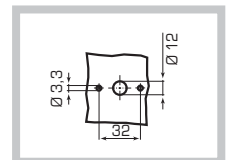

C025 - C032 - C040 SERIES

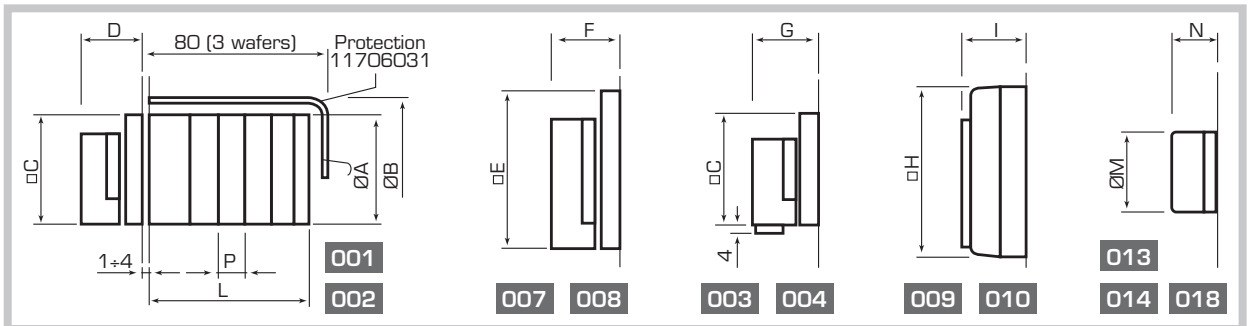

#### L x WAFERS No.

SERIES	1	2	3	4	5	6	P	A	B	C	D	E	H	I	M	N		
P012 - P016 - P020	39	51,7	64,4	77,1	89,8	102,5	12,7	45	63	48	30,2	64	30,2	35,2	67	30,2	34	18,8
C025 - C032 - C040	41,5	59	76,5	94	111,5	129	17,5	62	-	48	30,2	64	30,2	35,2	67	30,2	34	18,8

### PANEL MOUNTED WITH 22.5 Ø HOLE

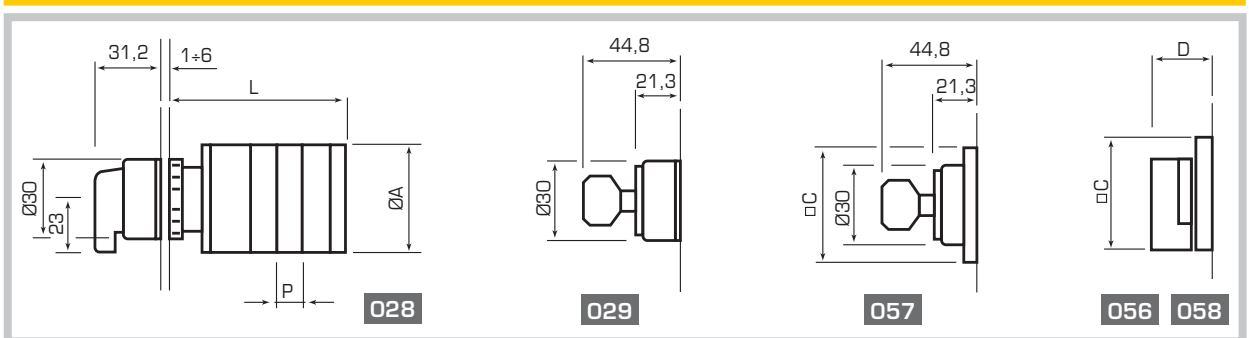

#### FIXING HOLE

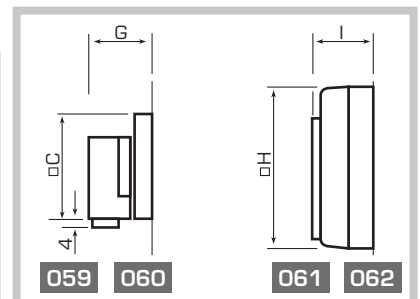
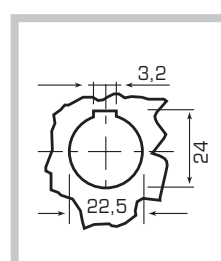

#### L x WAFERS No.

SERIES	1	2	3	4	5	6
P012 - P016 - P020	58,2	70,9	83,6	96,3	109	121,7



### BASE MOUNTING FOR DOOR INTERLOCK

#### BASE MOUNTING - DOOR INTERLOCK

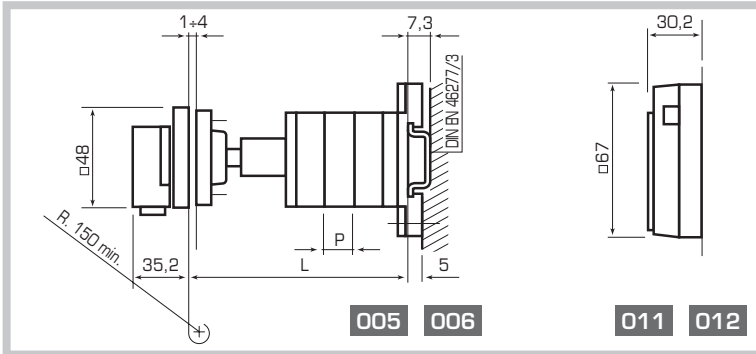

#### FIXING HOLES

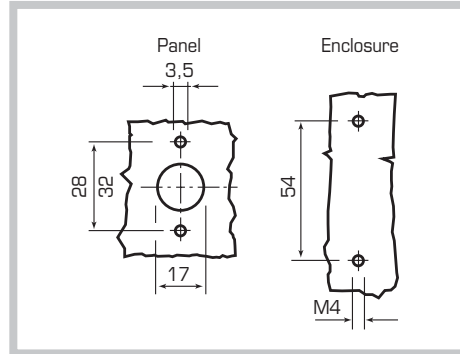

L x WAFERS No. WITH SHAFT AS STANDARD

SERIES	L x WAFERS No. WITH SHAFT AS STANDARD						P	
	1	2	3	4	5	6		
P012 - P016 - P020	min	76,7	89,4	102,1	114,8	127,5	140,2	12,7
	max	134,7	147,4	160,1	172,8	185,5	198,2	

L x WAFERS No. WITH SHAFT EXTENSION (ref. No. 20401089)

L x WAFERS No. WITH SHAFT EXTENSION (ref. No. 20401089)						
1	2	3	4	5	6	
min	76,7	89,4	102,1	114,8	127,5	140,2
max	234,7	247,4	260,1	272,8	285,5	298,2

### BASE MOUNTING WITH 22.5 Ø HOLE - DOOR INTERLOCK

#### BASE MOUNTING - DOOR INTERLOCK

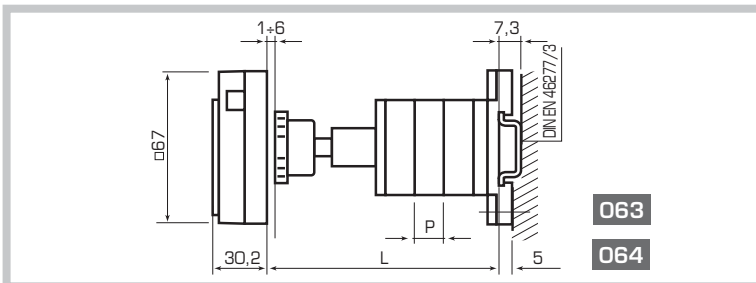

#### FIXING HOLES

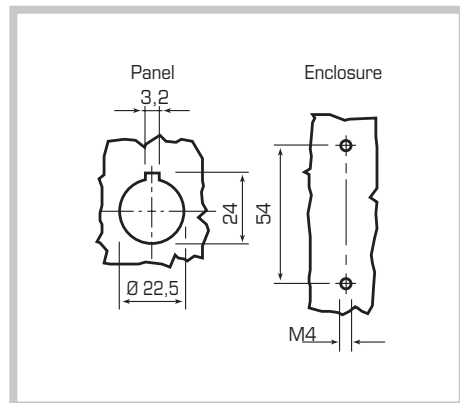

L x WAFERS No. WITH SHAFT AS STANDARD

SERIES	L x WAFERS No. WITH SHAFT AS STANDARD						P	
	1	2	3	4	5	6		
P012 - P016 - P020	min	76,7	89,4	102,1	114,8	127,5	140,2	12,7
	max	134,7	147,4	160,1	172,8	185,5	198,2	

### BASE MOUNTING - 46 mm STANDARD ENCLOSURES

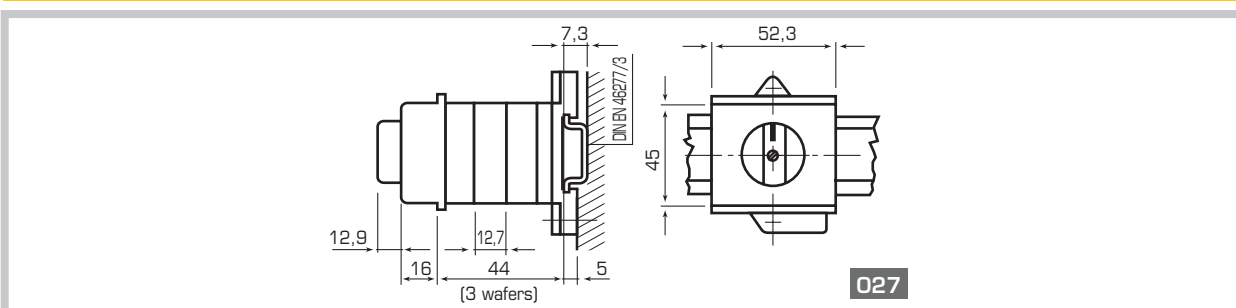



# Phoenix

## Cam switches

### Circuit diagrams

#### SWITCHES

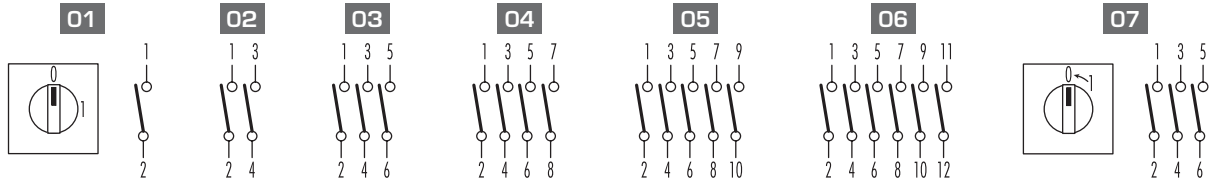

#### LINE CHANGEOVER SWITCHES

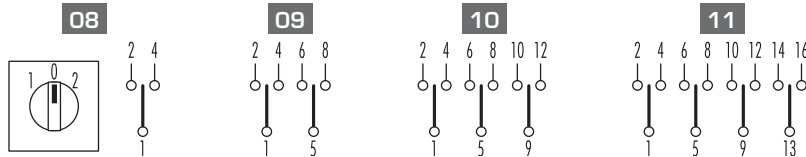

#### MOTOR CHANGEOVER SWITCHES

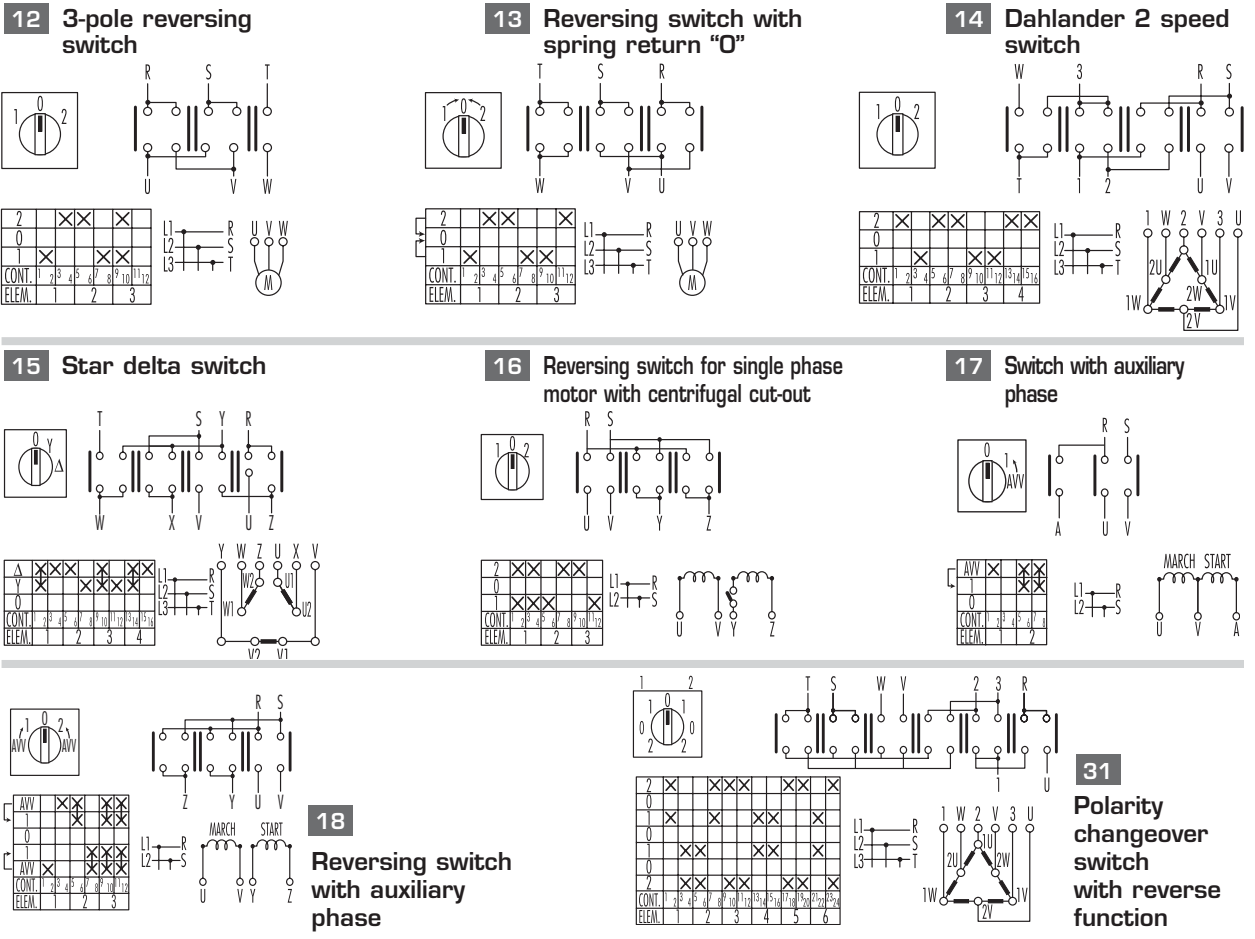



# Phoenix

## Cam switches

Special diagram on request

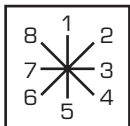

45° - 90°

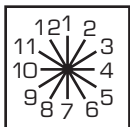

30° - 60°

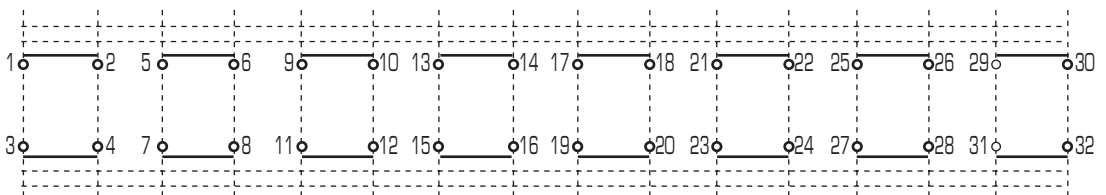

POS.	DESCRIPTION	POS.	DESCRIPTION
1		7	
2		8	
3		9	
4		10	
5		11	
6		12	

10	39-40				
	37-38				
9	35-36				
	33-34				
8	31-32				
	29-30				
7	27-28				
	25-26				
6	23-24				
	21-22				
5	19-20				
	17-18				
4	15-16				
	13-14				
3	11-12				
	9-10				
2	7-8				
	5-6				
1	3-4				
	1-2				
Wafer	Contact				Position

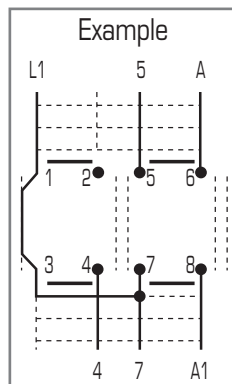

2	7-8			X
	5-6		X	X
1	3-4	X	X	
	1-2		X	
Wafer	Contact			
		0	1	M
		Position		

- Open contact
- Closed contact
- Break before make
- Contact closed: no interruption during change-over
- Spring return
- Make before break
- Open contact early make

### Rated current Ie Operational rated voltage Ue

Category	Amp/kw	Volt
<input type="checkbox"/> AC-21A	A	V
<input type="checkbox"/> AC-22A	A	V
<input type="checkbox"/> AC-23A	1Ph	kW
	3Ph	kW
<input type="checkbox"/> AC-3	1Ph	kW
	3Ph	kW

### Series

### Mounting:

- Panel mounting
- Base mounting
- DIN rail

### Operating:

### Notes:

### Company

### Contact Mr

Ph. \_\_\_\_\_  
 Fax \_\_\_\_\_  
 E-mail \_\_\_\_\_  
 Quantity \_\_\_\_\_  
 Due date \_\_\_\_\_  
 Order No. \_\_\_\_\_

# Regolus

## Switch-disconnectors

Table of contents



TECHNO-CONTROL EQUIPMENT



Current rating from 32 up to 100A. Panel, base and DIN rail mounted. Available in the 2, 3 and 4-pole version with central control knob and through shaft. 2 and 3-pole fuse holders for switch-disconnectors up to 32A.

### TABLE OF CONTENTS

■ Switch-disconnectors	pag.36	■ Technical data	pag.40
■ Control knob type	pag.37	■ Assembly	pag.42
■ Enclosed installation	pag.38	■ Dimensions	pag.43
■ Accessories	pag.39		

# Regolus

## Switch-disconnectors

IP 20



SE16  
SE32

Base mounting B  
For installation  
on DIN-EN50022-35 rail  
for door interlocks

SE63  
SE80  
SE100



SERIES	AC21A AMP. 690V	AC23A AMP. 400V	2-POLE			3-POLE			4-POLE		
			Diagram	1L1 N 2T1 N	Diagram	1L1 3L2 5L3 2T1 4T2 6T3	Diagram	1L1 3L2 5L3 N 2T1 4T2 6T3 N			
SE16	32	25	SE1610F2B		SE163003B		SE163004B				
SE32	40	32	SE3210F2B		SE323003B		SE323004B				
SE63	63	50	SE630002B		SE630003B		SE630004B				
SE80	80	60	SE800002B		SE800003B		SE800004B				
SE100	100	67	SE1000002B		SE1000003B		SE1000004B				



SE16  
SE32

Panel  
mounting R

SE63  
SE80  
SE100



SERIES	AC21A AMP. 690V	AC23A AMP. 400V	2-POLE			3-POLE			4-POLE		
			Diagram	1L1 N 2T1 N	Diagram	1L1 3L2 5L3 2T1 4T2 6T3	Diagram	1L1 3L2 5L3 N 2T1 4T2 6T3 N			
SE16	32	25	SE1610F2R		SE163003R		SE163004R				
SE32	40	32	SE3210F2R		SE323003R		SE323004R				
SE63	63	50	SE630002R		SE630003R		SE630004R				
SE80	80	60	SE800002R		SE800003R		SE800004R				
SE100	100	67	SE1000002R		SE1000003R		SE1000004R				

# Regolus

## Switch-disconnectors

IP65 Control knob





TECHNO-CONTROL EQUIPMENT

### BASE MOUNTING CONTROL KNOBS FOR DOOR INTELLOCK

		
□ 48    ■	□ 48    ■	□ 67    ■
Standard control knob	Black knob with locking facility	Grey escutcheon, black disc-type knob with locking facility for 3 padlocks
SE16	SE16	SE16    SE63
SE32	SE32	SE32    SE80
		SE100
020/0001	005/0001	011/0001    041/0001 063/0001*    065/0001*

### FOR ...B DEVICES



		
□ 48    ■	□ 48    ■	□ 67    ■
Red knob	Red knob locking facility	Yellow escutcheon, Red disc-type knob with locking facility for 3 padlocks
SE16	SE16	SE16    SE63
SE32	SE32	SE32    SE80
		SE100
030/0001	006/0001	012/0001    042/0001 064/0001*    066/0001*

\* Central fixing version Ø 22,5

### PANEL MOUNTING CONTROL KNOBS

		
□ 48    ■	□ 48    ■	□ 67    ■
Standard control knob	Black knob with locking facility	Grey escutcheon, black disc-type knob with locking facility for 3 padlocks
SE16	SE16	SE16    SE63
SE32	SE32	SE32    SE80
		SE100
001/0001	003/0001	009/0001    049/0001

### FOR ...R DEVICES

		
□ 48    ■	□ 48    ■	□ 67    ■
Red knob	Red knob locking facility	Yellow escutcheon, Red disc-type knob with locking facility for 3 padlocks
SE16	SE16	SE16    SE63
SE32	SE32	SE32    SE80
		SE100
002/0001	004/0001	010/0001    050/0001

# Regolus

## Enclosed installation

Enclosed installation IP65 □

- Lid released when knob in O/OFF position only
- No. 8 knock-outs
- Heat resistant material



**C10**



**C09**



**C01**

**3-POLE**

**4-POLE**

**3-POLE**

**4-POLE**

**3-POLE**

**4-POLE**

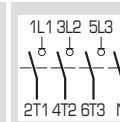
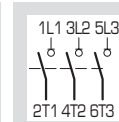
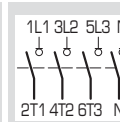
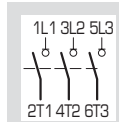
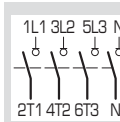
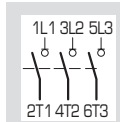

SERIES	AC-21A AMP. 690V		AC-23A AMP. 400V	
	32	25	32	25
SE16	SE160003BC10	SE160004BC10	SE160003BC09	SE160004BC09
SE32	SE320003BC10	SE320004BC10	SE320003BC09	SE320004BC09
			SE320003BC01	SE320004BC01

- Lid released when knob in O/OFF position only
- Provision for No. 2 M32 and No. 2 M40 cable glands
- Heat resistant material



**C41**



**C42**

**3-POLE**

**4-POLE**

**3-POLE**

**4-POLE**

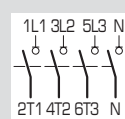
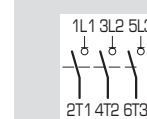
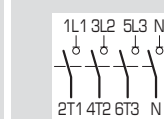
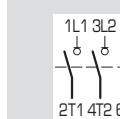

SERIES	AC-21A AMP. 690V		AC-23A AMP. 400V	
	63	50	60	67
SE63	SE630003BC41	SE630004BC41	SE630003BC42	SE630004BC42
SE80	SE800003BC41	SE800004BC41	SE800003BC42	SE800004BC42
SE100	SE100003BC41	SE100004BC41	SE100003BC42	SE100004BC42

# Regolus

## Switch-disconnectors

### Accessories



TECHNO-CONTROL EQUIPMENT

- Thermoplastic enclosure for SE 16-SE32 B BOX series
- IP65
- Dimensions
- Order also:  
Shaft 11706237  
Fixing plate 11814005



**BF1/1NGO**

- Thermoplastic enclosure for SE 16-SE32 R series
- Panel mounting



**BF1/2NGO**

- Aluminium enclosure for SE 16-SE32 R series 102x102x81
- IP65
- Sand finish
- No. 2 Ø 20.5 holes
- Lid □ 106



**BFM/3ASO**

- Fuse holder for SE 16-SE32 BOX series
- For 32A 10.3x38 max. fuses
- Terminal protection class IP20



2-Pole	TF322
3-Pole	TF323

**SHAFT FOR BF1/NGO ENCLOSURE**



SE16-SE32 B Series  
**11706237**

**SHAFT EXTENSION □ 5 SERIES SE16-SE32**

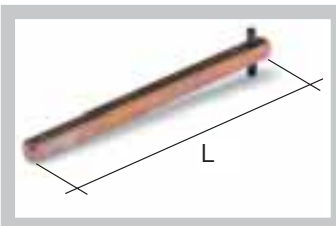

L 185 mm	20401089
L 300 mm	20401164

**ENCLOSURE FIXING PLATE**



SE16-SE32 B Series  
**11814005**

**SHAFT EXTENSION □ 6 SERIES SE63-SE100**

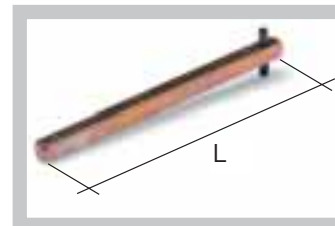

L 185 mm	20900010
L 300 mm	20900011

**AUXILIARY CONTACTS**

- SE16-SE32 Series
- IEC/EN 60947-5-1
- Ith 16A-690V ac
- AC15 6A-230V/4.5A-400V
- UL508 A600-Q600
- Order also:  
Fixing plate 11814021
- No. 1 pc. for each contact



1 NC	PL004001
1 NO	PL004002

**FIXING PLATE FOR AUXILIARY CONTACTS**



SE16-SE32 Series  
**11814021**



# Regolus

## Technical data

### Electrical characteristics

CHARACTERISTICS IEC/EN60947-3			SE16	SE32	SE63	SE80	SE100	
Rated operating voltage Ue	V		690*	690*	690	690	690	
Rated insulation voltage Ui	V		690*	690*	690	690	690	
Rated impulse withstand voltage Uimp	kV		4*	4*	8	8	8	
Rated thermal current Ith	A		(30*) 32	40*	63*	86*	100	
Rated thermal current enclosed Ithe	A		(30*) 32	40*	63*	86*	86	
Frequency	Hz		50	50	50	50	50	
<b>RATED OPERATING CURRENT Ie: alternate current</b>								
AC-21A Switching resistive loads with light overloads	690V	A	(30*) 32	(32*) 40	63*	80*	100	
AC-22A Switching mixed resistive and inductive loads with light overloads	500V	A	-	-	-	-	100	
	690V	A	(20*) 25	32*	63*	80*	86	
AC-23A Periodic switching of motors	3-phase - 3-pole	230V	A/kW	25/7.5	32/10	50/15	63/18.5	70/22
		400V	A/kW	25/15	32/18.5	50/30	60/33	67/37
		500V	A/kW	25/15	32/22	50/37	60/40	67/45
		690V	A/kW	(16A*) 20/18.5	25*/22	32/30	35/33	38/37
AC3 Starting of cage motors (interruption while running)	3-phase - 3-pole	230V	A/kW	22/7.5	30/9	40/11	50/15	60/18.5
		400V	A/Kw	22/11	30/15	40/22	50/25	55/30
		500V	A/kW	22/11	30/18,5	40/30	50/33	55/37
		690V	A/kW	(12A*) 22/11	(20A*) 22/18.5	25/22	27/25	32/30
AC-23A rated breaking capacity (cosφ 0.45)		110V	A/kW	256	256	560	560	560
		230V	A/kW	256	256	536	536	536
		230V	A/Kw	256	256	536	536	536
		400V	A/kW	200	200	304	304	304
<b>SHORT-CIRCUIT CHARACTERISTICS</b>								
Rated short-time short circuit withstand current Icw (1s)	A		400*	400*	1500	1500	1500	
Rated short circuit making capacity Icm	A		1500*	1500*	2840	2840	2840	
Conditional rated short circuit withstand current	kA		10*	10*	10*	10*	10	
Fuse rating gG	500V	A	-	-	-	-	100	
	690V	A	40*	40*	(80*) 63	80*	-	
<b>UL508 CHARACTERISTICS</b>								
General Use	600V ac	A	32	40	63	80	100	
Standard motors load	1-phase - 2-pole	120V ac HP(FLA)	1.5 (20)	2 (24)	3 (34)	3(34)	3 (34)	
		240V ac HP(FLA)	3 (17)	5 (28)	7.5 (40)	7,5 (40)	10 (50)	
		240V ac HP(FLA)	7.5 (22)	10 (28)	10 (28)	10 (28)	10 (28)	
	3-phase - 3-pole	480V ac HP(FLA)	10 (14)	15 (21)	20 (27)	25 (34)	25 (34)	
		600V ac HP(FLA)	15 (17)	20 (22)	25 (27)	30 (32)	30 (32)	

\* Values certified by IMQ

# Regolus

## Switch-disconnectors

General characteristics



TECHNO-CONTROL EQUIPMENT

Comply with			IEC947-3, EN60947-3, UL508				
			SE16 - SE32		SE63 - SE80 - SE100		
Protection class	controls	EN60529	IP65		IP65		
	terminals		IP20		IP20		
Material group		EN60947-1	II		II		
Pollution grade		EN60947-1	3		3		
Flammability		UL94	VO: live parts				
Ambient temperature		°C	Operating: -25 +55				
		°C	Storage: -30 +70				
Climate protection		IEC68 part 2-3	Hot damp				
		IEC68 part 2-30	Unsettled hot damp				
Minimum tripping force (4-pole)			0.7 Nm (6.3 lb.in.)		1.8 Nm (16 lb.in.)		
Terminals:							
Dimensions		EN60947-1	A6		A8		
Terminal screw			M4		M5		
Torque		EN60947-1	0.8 Nm (7.2 lb.in.)		1.2 Nm (10.6 lb.in.)		
		UL508	7.5 lb.in. (0.85 Nm)		12 lb.in. (1.4 Nm)		
Capacity:							
Flexible conductors	No. 1 min/max	mm <sup>2</sup>	1.5-10		6-25		
		AWG	16-3		10-2		
Solid conductors	No. 1 min/max	mm <sup>2</sup>	1.5-16		10-35		
		AWG	16-8		10-2		
Contacts			Double gap contacts with positive opening action				
Opening angles			90°		90°		
Mechanical life	120 operations per hour	mil./cycles	0.1		0.1		
CE mark – Europa			■	■	■	■	■
CUL Listed – USA and Canada			●	●	●	●	●
Istituto Marchio Qualità (IMQ) – Italy			●	●	●	●	-
CCC Cina			●	●	●	●	-
GOST-R Russia			●	●	●	●	-

■ Meets or exceed the minimum requirements      ● Certified

# Regolus

## Switch-disconnectors

### Assembly

#### ASSEMBLY EXPLODED VIEW

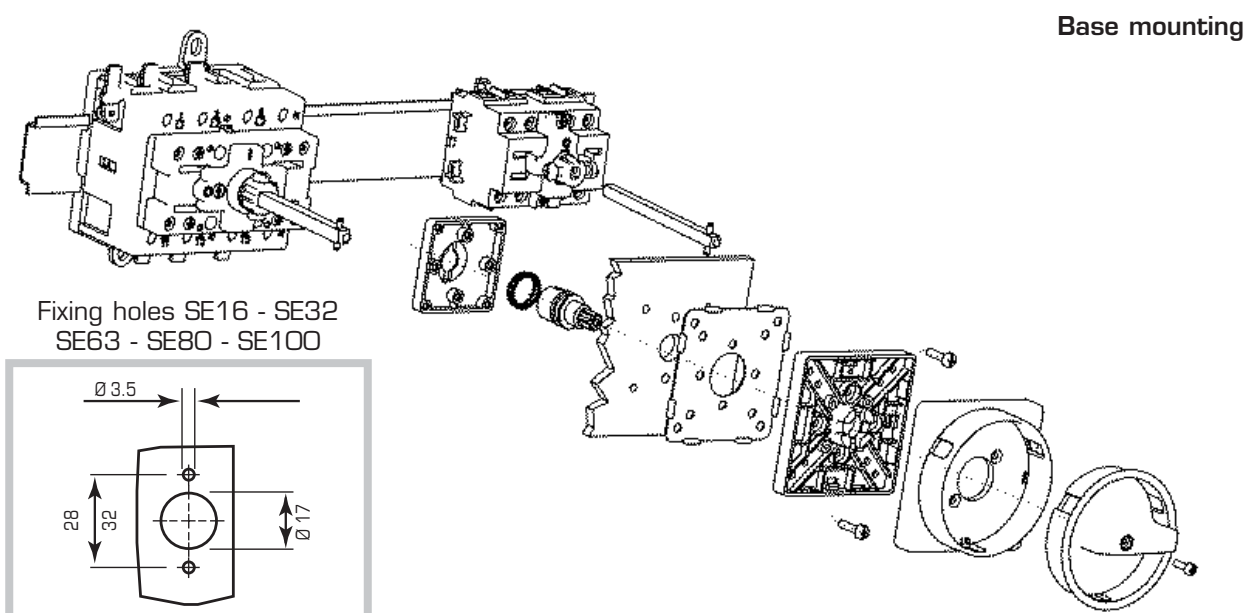
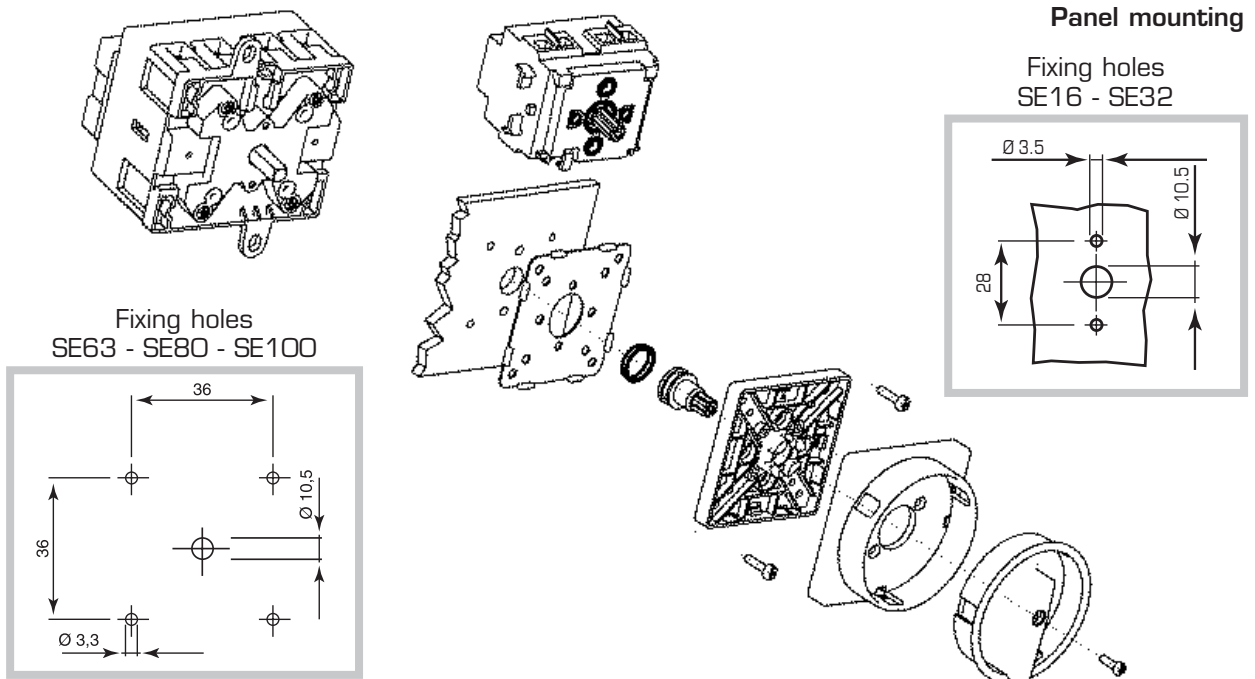

# Regolus

## Dimensions

Fixing holes



TECHNO-CONTROL EQUIPMENT

### PANEL MOUNTING

**SE16-SE32 R**

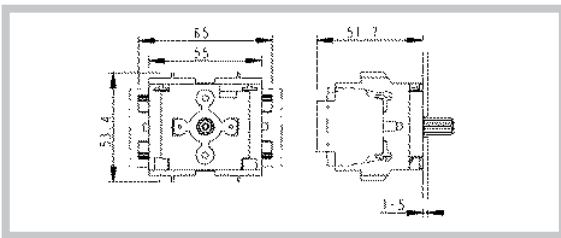

**SE63-SE80-SE100 R**

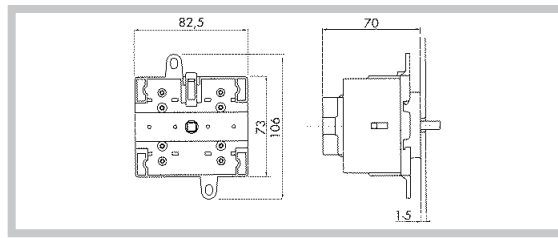

### BASE MOUNTING

**SE16-SE32 B**

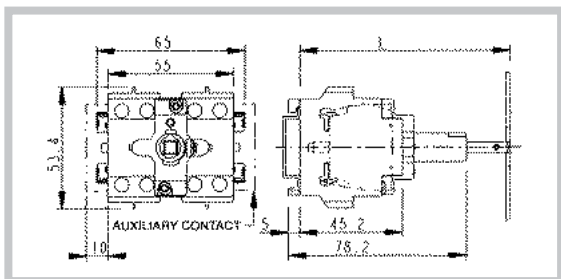

**DEPTH**

	WITH SHAFT AS STANDARD	WITH 20401089 EXTENSION
L min	80	80
L max	120	220

**SE63-SE80-SE100 B**

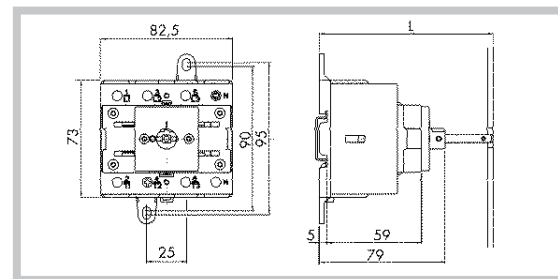

**DEPTH**

	WITH SHAFT AS STANDARD	WITH 20900010 EXTENSION
L min	98	98
L max	128	228

### ENCLOSED INSTALLATION

**SE16-SE32**

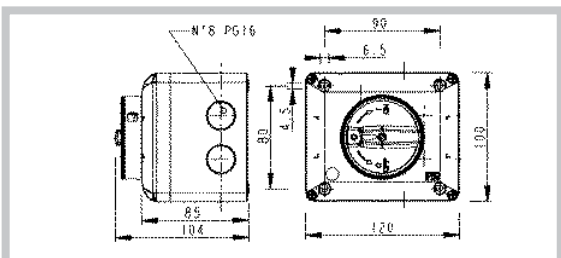

**SE63-SE80-SE100**

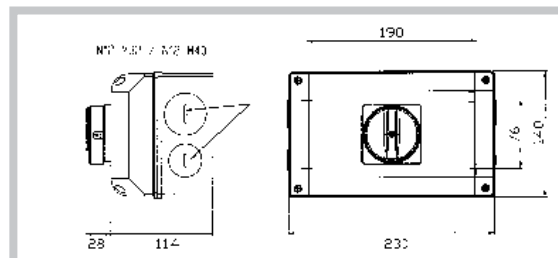



# Pegasus

## Control auxiliaries

### Table of contents



TECHNO-CONTROL EQUIPMENT



Panel mounting on  $\varnothing$  22.5 mm holes, IP65 protection rating, available with "black" or "chrome" finish, EN418 emergency mushrooms, terminals with screws, spring loaded or for printed circuit boards. Push button stations up to 3 gang or enclosures up to 6 gang. Version for pneumatic systems available.

### TABLE OF CONTENTS

■ Assembly	pag. 46	■ Contact blocks – Power supplies	pag. 58
■ $\varnothing$ 22 push buttons with colour cap	pag. 47	■ Spring loaded terminals	
■ EN 418 emergency push buttons	pag. 48	■ Contact blocks – Power supplies	pag. 59
■ Rotary switches	pag. 50	■ Screw terminals	
■ $\varnothing$ 22 push buttons with lens cap	pag. 51	■ IP65 push button stations (single function)	pag. 60
■ LED pilot lights – Multi-function push buttons	pag. 52	■ EN418 emergency push button stations	pag. 61
■ Joystick operators	pag. 53	■ IP65 push button stations (multi-function)	pag. 62
■ Chrome line $\varnothing$ 22 push buttons with colour cap	pag. 54	■ Push button station enclosures	pag. 63
■ Chrome line rotary switches	pag. 55	■ Pneumatic valve adapters	pag. 64
■ Chrome line $\varnothing$ 22 push buttons with lens cap	pag. 56	■ Accessories	pag. 65
■ Chrome line multi-function push buttons	pag. 57	■ Accessories – Push buttons with symbols	pag. 66
		■ Electrical characteristics	pag. 68
		■ General characteristics	pag. 69

# Pegasus

## Control auxiliaries

### Assembly instructions

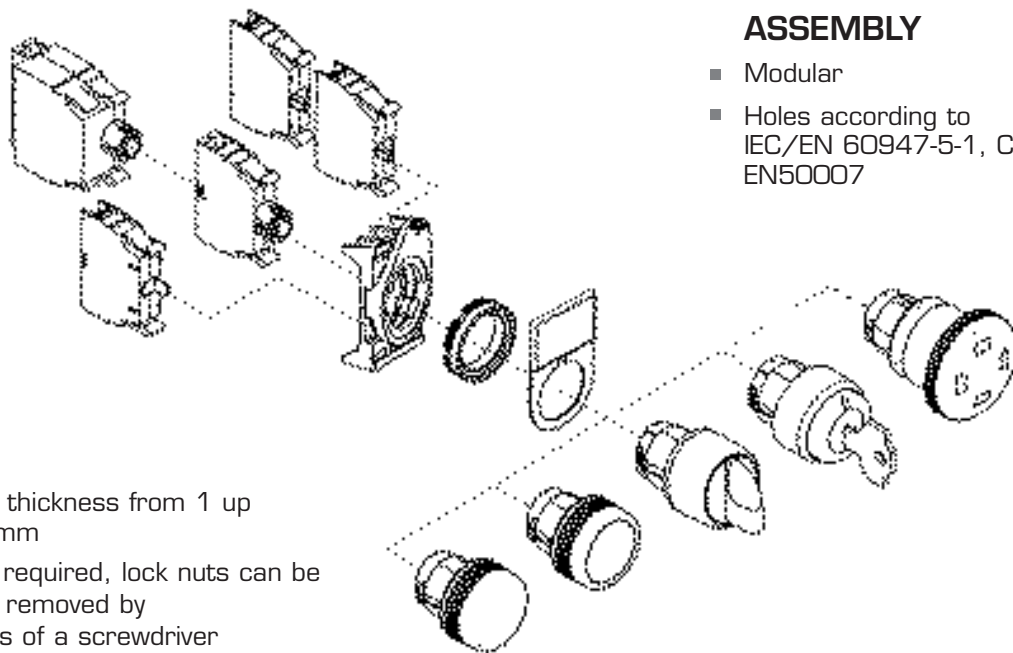

#### ASSEMBLY

- Modular
- Holes according to IEC/EN 60947-5-1, CENELEC EN50007

- Panel thickness from 1 up to 6 mm
- If not required, lock nuts can be easily removed by means of a screwdriver

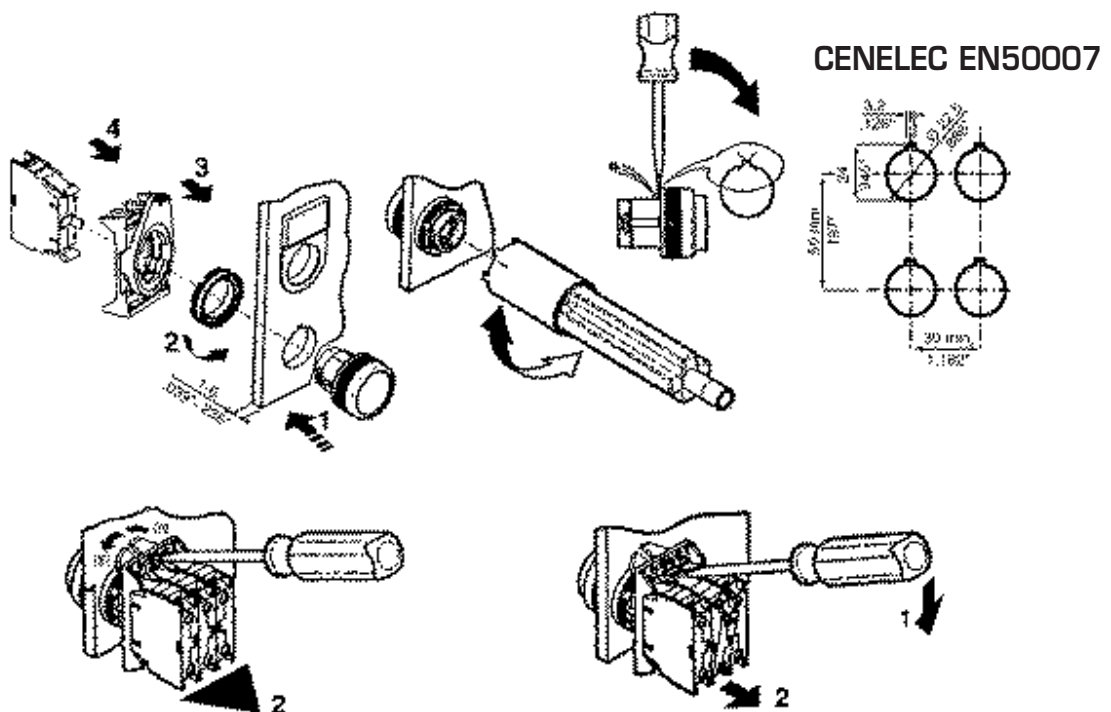













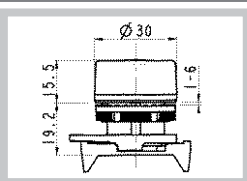







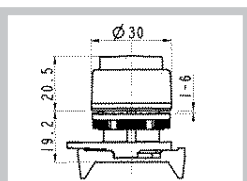







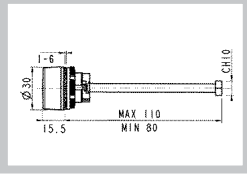

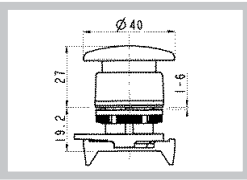



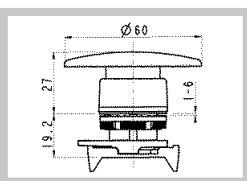

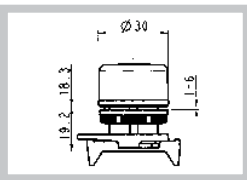
# Pegasus

## ø 22 Push buttons

With colour cap

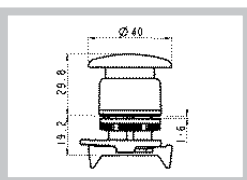

TECHNO-CONTROL EQUIPMENT









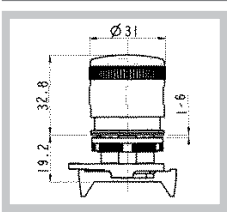

STANDARD	DESCRIPTION	COLOUR	REF. NO.	WEIGHT g	MIN. PACK QTY.	DIMENSIONS			
	Flush push button		PPRN1	30	10				
			PPRN2	30	10				
			PPRN3	30	10				
			PPRN4	30	10				
			PPRN5	30	10				
			PPRN8	30	10				
			Extended push button		PPSN1		31	10	
					PPSN2		31	10	
	PPSN3			31	10				
	PPSN4			31	10				
	PPSN5			31	10				
	PPSN8			31	10				
	Flush reset push button				PPRN4R	43	10		
	Mushroom operator ø 40				PPFN1M4N	35	10		
			PPFN2M4N	35	10				
			PPFN3M4N	35	10				
	Mushroom operator ø 60		PPFN1M6N	40	10				
<b>LATCHED</b>									
	Flush push button		PPP1	32	10				
			PPP2	32	10				
			PPP3	32	10				
			PPP4	32	10				
			PPP5	32	10				
			PPP8	32	10				
			Mushroom operator ø 40		PPFN1S4N		35	10	
					PPFN2S4N		35	10	
	PPFN3S4N			35	10				

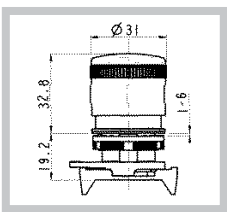

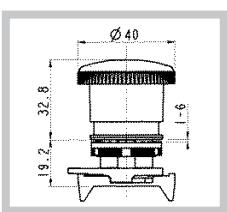
# Pegasus

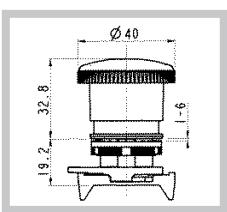
## Emergency push buttons

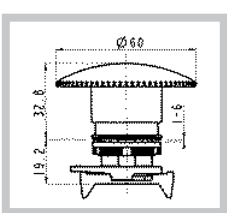
EN418

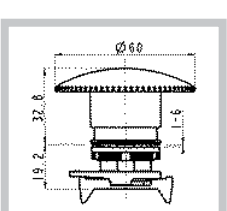
	DESCRIPTION	COLOUR	REF. NO.	WEIGHT g	MIN. PACK QTY.	DIMENSIONS
	Mushroom operator ø 30 twist to release	■	PPFN1R3N	42	10	
	Mushroom operator with vision ø 30 twist to release	■	PPFN1R3S	44	10	
	Mushroom operator ø 40 twist to release	■	PPFN1R4N	44	10	
	Mushroom operator with vision ø 40 twist to release	■	PPFN1R4S	46	10	
	Mushroom operator ø 60 twist to release	■	PPFN1R6N	50	10	
	Mushroom operator with vision ø 60 twist to release	■	PPFN1R6S	52	10	







# Pegasus

## Emergency push buttons

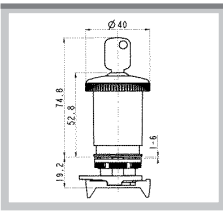
EN418

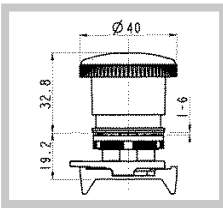

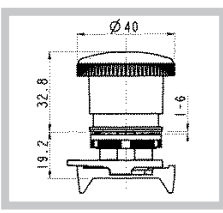
TECHNO-CONTROL EQUIPMENT

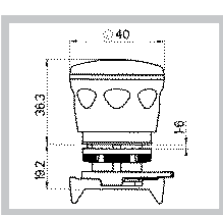
	DESCRIPTION	COLOUR	REF. NO.	WEIGHT g	MIN. PACK QTY.	DIMENSIONS
	Mushroom operator ø 40 with key release	■	PPFN1C4N	76	10	
	Mushroom operator ø 40 push-pull	■	PPFN1P4N	44	10	
	Mushroom operator ø 40 push-pull with vision	■	PPFN1P4S	46	10	
	Mushroom operator ø 40 push-pull with colour cap	■	PPFN1P4C	45	10	
	Mushroom operator ø 40 push-pull with lens cap	■	PPFL1P4N	45	10	

### TECHNICAL NOTES

- All operators comply with the relevant European standard
- EN418 Machine safety  
Emergency stop operators, functional characteristics – Design guidelines
- IEC/EN60947-5-1
- Comply with the standard IEC/EN60204-1: Machine safety – Machine electrical circuits – General guidelines
- The push buttons are designed with a load charge mechanism to ensure a reliable operation and stoppage, or blockage, in the activated position. The combination with positive switching NC  $\ominus$  contacts and the presence of the “status” indicator on some models, guarantee a high degree of reliability and effectiveness.

# Pegasus

## Rotary switches

Standard and with lens

### WITH SHORT OPERATOR



### WITH LONG OPERATOR



### WITH KEY



POSITIONS	WITH SHORT OPERATOR		WITH LONG OPERATOR		KEY REMOVAL			REF.NO.
	COL.INDEX	REF.NO.	COL.INDEX	REF.NO.	Sn	O	Dx	
 <b>2</b>	■	PSMB1DO	■	PSLB1DO		*		PSCG8DOC
	■	PSMB2DO	■	PSLB2DO				
	■	PSMB3DO	■	PSLB3DO			*	PSCG8DOE
	■	PSMB4DO	■	PSLB4DO				
	■	PSMB5DO	■	PSLB5DO		*	*	PSCG8DON
	■	PSMB8DO	■	PSLB8DO				
	■	PSMB1D2	■	PSLB1D2		*		PSCG8D2C
	■	PSMB2D2	■	PSLB2D2				
	■	PSMB3D2	■	PSLB3D2				
	■	PSMB4D2	■	PSLB4D2				
	■	PSMB5D2	■	PSLB5D2				
	■	PSMB8D2	■	PSLB8D2				
	■	PSMB1T0	■	PSLB1T0	*	*		PSCG8TOC
	■	PSMB2T0	■	PSLB2T0	*			PSCG8TOA
	■	PSMB3T0	■	PSLB3T0	*	*	*	PSCG8TOE
	■	PSMB4T0	■	PSLB4T0	*	*	*	PSCG8TOG
	■	PSMB5T0	■	PSLB5T0	*	*	*	PSCG8TOH
	■	PSMB8T0	■	PSLB8T0	*	*	*	PSCG8TON
	■	PSMB1T3	■	PSLB1T3		*		PSCG8T3C
	■	PSMB2T3	■	PSLB2T3				
	■	PSMB3T3	■	PSLB3T3				
	■	PSMB4T3	■	PSLB4T3				
	■	PSMB5T3	■	PSLB5T3				
	■	PSMB8T3	■	PSLB8T3				
	■	PSMB1T2	■	PSLB1T2		*		PSCG8T2C
	■	PSMB2T2	■	PSLB2T2				
	■	PSMB3T2	■	PSLB3T2	*			PSCG8T2A
	■	PSMB4T2	■	PSLB4T2				
	■	PSMB5T2	■	PSLB5T2	*	*		PSCG8T2H
	■	PSMB8T2	■	PSLB8T2				
	■	PSMB1T1	■	PSLB1T1		*		PSCG8T1C
	■	PSMB2T1	■	PSLB2T1				
	■	PSMB3T1	■	PSLB3T1			*	PSCG8T1E
	■	PSMB4T1	■	PSLB4T1				
	■	PSMB5T1	■	PSLB5T1		*	*	PSCG8T1N
	■	PSMB8T1	■	PSLB8T1				

**1** For standard rotary switches suitable to operate a central contact, replace the letter "B" with the letter "C": PSMB...C...

**2** For rotary switches with Left-Right operating angles replace the letters "DO" with "SD": PSMB1SD or PSCG8SDC

\* Key removal position

# Pegasus

## Ø 22 push buttons

With lens cap



TECHNO-CONTROL EQUIPMENT

### STANDARD

DESCRIPTION	COL. INDEX	REF. NO.	WEIGHT g	MIN. PACK QTY.	DIMENSIONS
Flush push button		PPRL1	30	10	
		PPRL2	30	10	
		PPRL3	30	10	
		PPRL4	30	10	
		PPRL5	30	10	

Extended push button		PPSL1	31	10	
		PPSL2	31	10	
		PPSL3	31	10	
		PPSL4	31	10	
		PPSL5	31	10	

Mushroom operator Ø 40		PPFL1M4N	35	10	
------------------------	--	----------	----	----	--

### LATCHED

Flush push button		PPPL1	32	10	
		PPPL2	32	10	
		PPPL3	32	10	
		PPPL4	32	10	
		PPPL5	32	10	

Mushroom operator Ø 40		PPFL1S4N	35	10	
		PPFL2S4N	35	10	
		PPFL3S4N	35	10	

### INDICATOR LIGHT

Flat cap		PLSL1	30	10	
		PLSL2	30	10	
		PLSL3	30	10	
		PLSL4	30	10	
		PLSL5	30	10	

### PILOT LIGHT

BA9s E10		PLML1	15	10	
		PLML2	15	10	
		PLML3	15	10	
		PLML4	15	10	
		PLML5	15	10	

# Pegasus





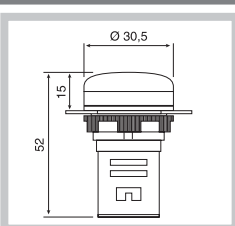

## LED pilot lights

Multi-function push buttons



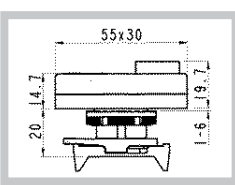

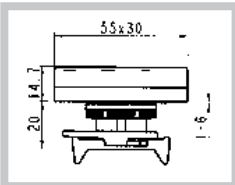
### LED PILOT LIGHTS

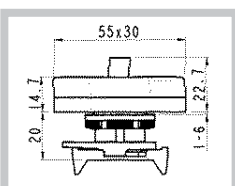
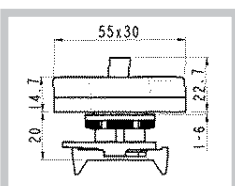
DESCRIPTION	POWER SUPPLY	REF. NO.	WEIGHT g	MIN. PACK QTY.	DIMENSIONS
 Single light indicator	AC110V	PLML 2 L110*	15	10	
	AC220V	PLML 2 L220*	15	10	
	AC380V <sup>1</sup>	PLML 2 L380	15	10	
	AC/DC 6V <sup>1</sup>	PLML 2 L6	15	10	
	AC/DC 12V <sup>1</sup>	PLML 2 L12	15	10	
	AC/DC 24V	PLML 2 L24	15	10	
	AC/DC 48V	PLML 2 L48	15	10	

### MULTI-FUNCTION PUSH BUTTONS

DESCRIPTION	COL. - SYMBOL	REF. NO.	WEIGHT g	MIN. PACK QTY.	DIMENSIONS
 Dual push button		PPDN	38	10	
 Flush dual push button		PPDNR	38	10	
		PPDNR.3	38	10	
 Triple push button		PPMN	40	10	

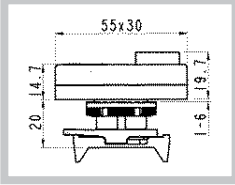
### MULTI-FUNCTION PUSHBUTTONS - WITH LENS

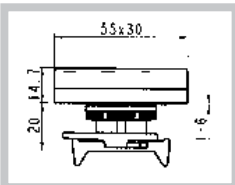
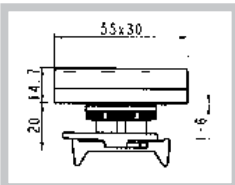
 Dual push button		PPDL	30	10	
 Flush dual push button		PPDLR	30	10	
		PPDLR.3	30	10	

<sup>1</sup> Made to order

<sup>2</sup> Insert lens colour code: 1 - red, 2 - green, 3 - yellow, 4 - blue, 5 - white

Multi-function push buttons - Special symbols and text for horizontal assembly/identification are available on request

\* For AC/DC applications add the letter "S": PLML.L110S

# Pegasus

## Joystick operators

With colour caps



TECHNO-CONTROL EQUIPMENT

### JOYSTICK OPERATORS

CONTACT BLOCKS		2 POSITIONS			4 POSITIONS				
		1	0	2	3	1	0	2	4
Left-hand side contact block	NO	0	0	X	X	0	0	0	0
	NC	X	0	0	0	0	0	0	X
Right-hand side contact block	NO	X	0	0	0	X	0	0	0
	NC	0	0	X	0	0	0	X	0



X Contact close

0 Contact open

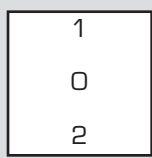
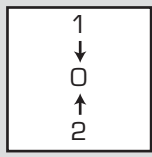
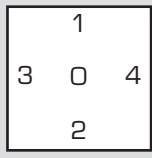
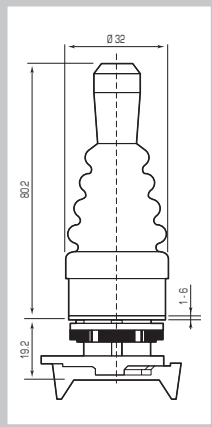
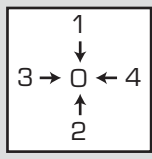
POSITIONS	REF.NO.	REF.NO.	WEIGHT g	MIN.PACK	DIMENSIONS
	PMJN8TO	-	54	5	
	PMJN8T3	-	54	5	
	-	PMJN8Q0	54	5	
	-	PMJN8Q4	54	5	













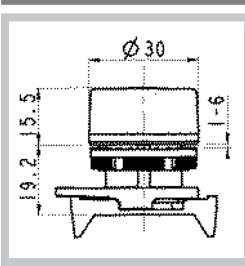





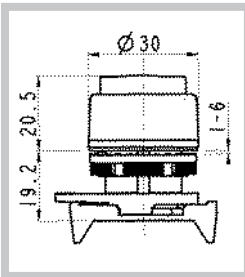

# Pegasus







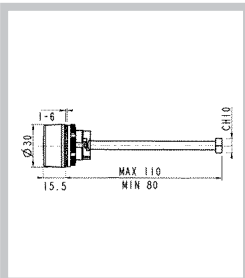

## Push buttons $\varnothing$ 22

With colour caps – Chrome line

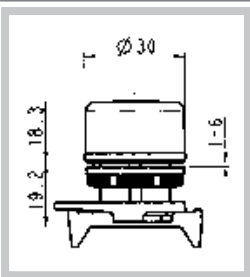
### STANDARD

	DESCRIPTION	COLOUR	REF. NO.	WEIGHT g	MIN. PACK QTY.	DIMENSIONS
	Flush push button		PPRN1CL	30	10	
			PPRN2CL	30	10	
			PPRN3CL	30	10	
			PPRN4CL	30	10	
			PPRN5CL	30	10	
			PPRN8CL	30	10	
	Extended push button		PPSN1CL	31	10	
			PPSN2CL	31	10	
			PPSN3CL	31	10	
			PPSN4CL	31	10	
			PPSN5CL	31	10	
			PPSN8CL	31	10	
	Flush reset push button		PPRN4RCL	43	10	

### LATCHED

	DESCRIPTION	COLOUR	REF. NO.	WEIGHT g	MIN. PACK QTY.	DIMENSIONS
	Flush push button		PPPN1CL	31	10	
			PPPN2CL	31	10	
			PPPN3CL	31	10	
			PPPN4CL	31	10	
			PPPN5CL	31	10	
			PPPN8CL	31	10	

# Pegasus

## Rotary switches

Standard and with lens – Chrome line



TECHNO-CONTROL EQUIPMENT

### WITH SHORT OPERATOR



### WITH LONG OPERATOR



### WITH KEY



POSITIONS	COL. INDEX	REF. NO.	COL. INDEX	REF. NO.	KEY REMOVAL			REF. NO.
					Sn	O	Dx	
		PSMB1DOCL		PSLB1DOCL		*		PSCG8DOCCCL
		PSMB2DOCL		PSLB2DOCL				
		PSMB3DOCL		PSLB3DOCL			*	PSCG8DOECL
		PSMB4DOCL		PSLB4DOCL			*	
		PSMB5DOCL		PSLB5DOCL		*	*	PSCG8DONCL
		PSMB8DOCL		PSLB8DOCL				
		PSMB1D2CL		PSLB1D2CL				
		PSMB2D2CL		PSLB2D2CL				
		PSMB3D2CL		PSLB3D2CL		*		PSCG8D2CCL
		PSMB4D2CL		PSLB4D2CL				
		PSMB5D2CL		PSLB5D2CL				
		PSMB8D2CL		PSLB8D2CL				
		PSMB1TOCL		PSLB1TOCL		*		PSCG8TOCCCL
		PSMB2TOCL		PSLB2TOCL	*		*	PSCG8TOACL
		PSMB3TOCL		PSLB3TOCL	*	*	*	PSCG8TOECL
		PSMB4TOCL		PSLB4TOCL	*	*		PSCG8TOGCL
		PSMB5TOCL		PSLB5TOCL	*		*	PSCG8TOHCL
		PSMB8TOCL		PSLB8TOCL		*	*	PSCG8TONCL
		PSMB1T3CL		PSLB1T3CL				
		PSMB2T3CL		PSLB2T3CL				
		PSMB3T3CL		PSLB3T3CL		*		PSCG8T3CCL
		PSMB4T3CL		PSLB4T3CL				
		PSMB5T3CL		PSLB5T3CL				
		PSMB8T3CL		PSLB8T3CL				
		PSMB1T2CL		PSLB1T2CL		*		PSCG8T2CCL
		PSMB2T2CL		PSLB2T2CL				
		PSMB3T2CL		PSLB3T2CL	*			PSCG8T2ACL
		PSMB4T2CL		PSLB4T2CL				
		PSMB5T2CL		PSLB5T2CL	*	*		PSCG8T2HCL
		PSMB8T2CL		PSLB8T2CL				
		PSMB1T1CL		PSLB1T1CL		*		PSCG8T1CCL
		PSMB2T1CL		PSLB2T1CL				
		PSMB3T1CL		PSLB3T1CL			*	PSCG8T1ECL
		PSMB4T1CL		PSLB4T1CL				
		PSMB5T1CL		PSLB5T1CL		*	*	PSCG8T1NCL
		PSMB8T1CL		PSLB8T1CL				

**1** For standard rotary switches suitable to operate a central contact, replace the letter "B" with the letter "C": PSMB...C...

**2** For rotary switches with Left-Right operating angles replace the letters "DO" with "SD": PSMB1SD or PSCG8SDC

\* Key removal position













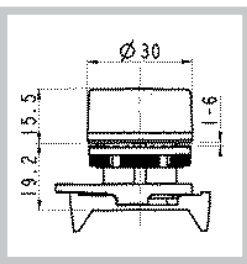



# Pegasus

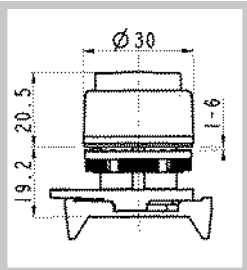



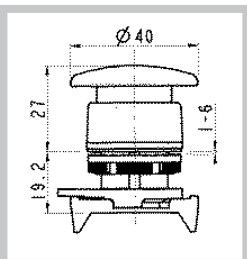

## Ø 22 push buttons

With lens cap – Chrome line

### STANDARD

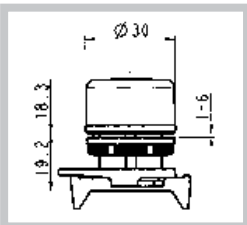
	DESCRIPTION	COLOUR	REF. NO.	WEIGHT g	MIN. PACK QTY.	DIMENSIONS
	Flush push button		PPRL1CL	30	10	
			PPRL2CL	30	10	
			PPRL3CL	30	10	
			PPRL4CL	30	10	
			PPRL5CL	30	10	
	Extended push button		PPSL1CL	31	10	
			PPSL2CL	31	10	
			PPSL3CL	31	10	
			PPSL4CL	31	10	
			PPSL5CL	31	10	
	Mushroom operator Ø 40		PPFL1M4NCL	43	10	

### LATCHED

	DESCRIPTION	COLOUR	REF. NO.	WEIGHT g	MIN. PACK QTY.	DIMENSIONS
	Flush push button		PPPL1CL	31	10	
			PPPL2CL	31	10	
			PPPL3CL	31	10	
			PPPL4CL	31	10	
			PPPL5CL	31	10	

# Pegasus





## Multi-function push buttons

Chrome line



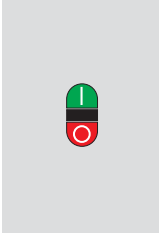
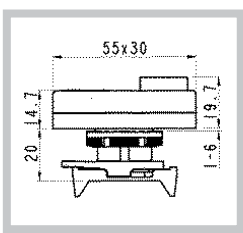

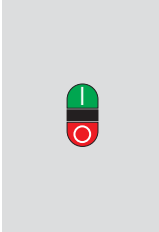
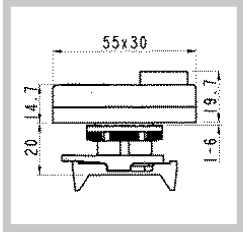
TECHNO-CONTROL EQUIPMENT

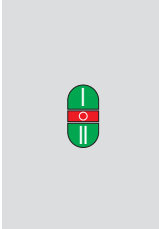
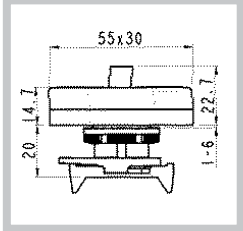
### MULTI-FUNCTION PUSH BUTTONS

	DESCRIPTION	COL. - SYMBOL	REF. NO.	WEIGHT g	MIN. PACK QTY.	DIMENSIONS
	Dual push button		PPDNCL	38	10	
	Flush dual push button		PPDNRCL	38	10	
	Triple push button		PPMNCL	40	10	

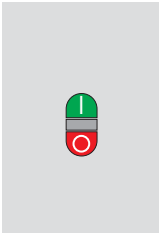
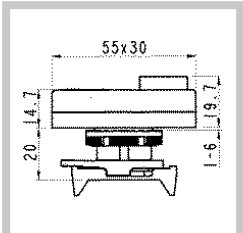
### MULTI-FUNCTION PUSH BUTTONS - WITH LENS

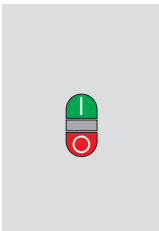
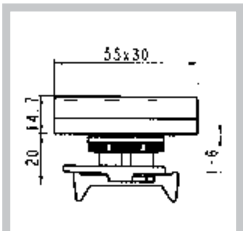
	Dual push button		PPDLCL	38	10	
	Flush dual push button		PPDLRCL	38	10	

**1** Made to order



Multi-function push buttons – Special symbols and text for horizontal assembly/identification are available on request

# Pegasus

## Contact blocks – Power supplies

Spring loaded and welding terminals

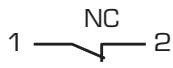

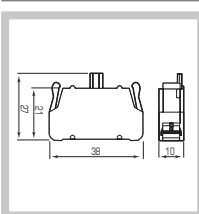
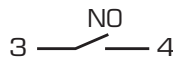
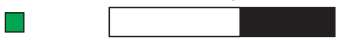
### SPRING LOADED TERMINALS

DESIGNATION	CONTACT BLOCKS		REF. NO.	DIMENSIONS
	FUNCTIONS			
 1 — NC — 2 3 — NO — 4		 0 1,5 6 mm	PCW01	
		 0 3,5 6 mm	PCW10	

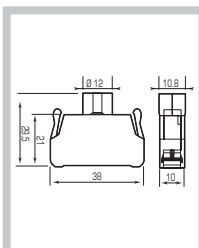
### LAMPHOLDER

DESIGNATION	DIRECT POWER SUPPLY		WITH BUILT-IN LED		DIMENSIONS
	POWER SUPPLY	REF. NO.	POWER SUPPLY	REF. NO.	
 X1 — ⊗ — X2	BA9s	PCWAD	AC/DC 12V	PCW5L12	
	250V max		Lamp <b>1</b>	AC/DC 24V	
	2,4W max		AC/DC 48V	PCW5L48	
			AC/DC 110V	PCW5L110	
			AC 220V	PCW5L220	

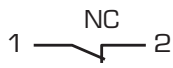
### WELDING TERMINALS - FOR PRINTED CIRCUIT BOARDS

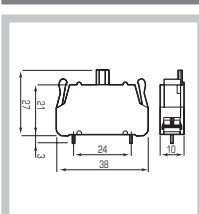
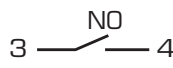
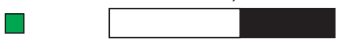
DESIGNATION	CONTACT BLOCKS		REF. NO.	DIMENSIONS
	FUNCTIONS			
 1 — NC — 2 3 — NO — 4		 0 1,5 6 mm	PSC01	
		 0 3,5 6 mm	PSC10	

### LAMPHOLDER

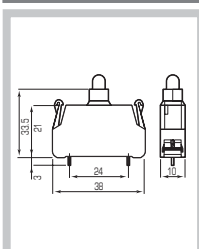
DESIGNATION	DIRECT POWER SUPPLY		WITH BUILT-IN LED		DIMENSIONS
	POWER SUPPLY	REF. NO.	POWER SUPPLY	REF. NO.	
 X1 — ⊗ — X2	BA9s	PSCAD	AC/DC 12V	PSC5L12	
	250V max		Lamp <b>1</b>	AC/DC 24V	
	2,4W max		AC/DC 48V	PSC5L48	
			AC/DC 110V	PSC5L110	
			AC 220V	PSC5L220	

**1** Lamp supplied separately

# Pegasus

## Contact blocks – Power supplies

Screw terminals



TECHNO-CONTROL EQUIPMENT

### CONTACT BLOCKS

	DESIGNATION	FUNCTIONS	REF. NO.	DIMENSIONS
	1 — 2 NC			
	3 — 4 NO			

### LAMPHOLDER

	DESIGNATION	DIRECT POWER SUPPLY		WITH BUILT-IN LED		DIMENSIONS
		POWER SUPPLY	REF. NO.	POWER SUPPLY	REF. NO.	
	X1 — ⊗ — X2	BA9s	PLO04007	AC/DC 12V	PLO045L12	
		250V max Lamp  1 2,4W max		AC/DC 24V	PLO045L24	
				AC/DC 48V	PLO045L48	
				AC/DC 110V	PLO045L110	
				AC 220V	PLO045L220	

### POWER SUPPLY WITH DIODE AND RESISTORS

	DESIGNATION	SUPPLY	LAMP  1	REF. NO.	DIMENSIONS
	X1 — ⊗ — X2	110/130V	48/60V -2W max	PLO04RD1	
	X1 — ⊗ — X2	220/240V	110/130V -2W max	PLO04RD2	

### POWER SUPPLY WITH TRANSFORMER

	DESIGNATION	SUPPLY	LAMP  1	REF. NO.	DIMENSIONS
		110/130V	24V-1,5 max	PLO04TR1	
		220/240V	24V-1,5 max	PLO04TR2	
		380/440V	24V-1,5 max	PLO04TR3	

### POWER SUPPLY WITH FLASHING LIGHT









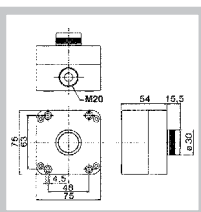

	DESIGNATION	SUPPLY	LAMP  1	REF. NO.	DIMENSIONS
		24V	24V-2,6 max	PLO04LA1	
		110/130V	110/130V-2,6 max	PLO04LA2	

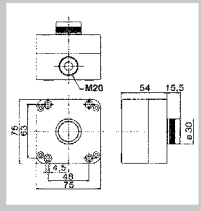
1 Lamp supply separately

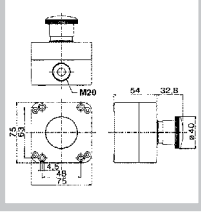
# Pegasus

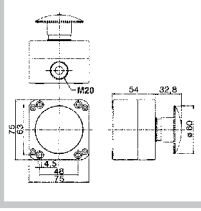
## Push button stations

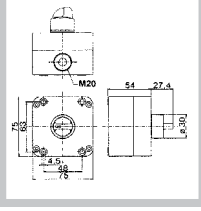
IP65 □ Screw terminal contact blocks

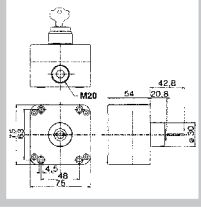











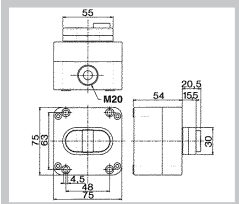

	DESCRIPTION	COL.	DESIGNATION	REF.NO.	WEIGHT g	MIN. PACK QTY.	DIMENSIONS
	Flush push button	■	3 — 4	PQ01RN2	176	1	
		■	1 — 2	PQ01RN1	176	1	
	Latched flush push button	■	3 — 4	PQ01PN2	176	1	
	Emergency stop ø 40	■	1 — 2	PQ01M4N	192	1	
	Emergency stop ø 60	■	1 — 2	PQ01M6N	198	1	
	Short operator latched rotary switch Q-1	□	3 — 4	PQ01SMN8DO	174	1	
	90° angle latched key switch Q-1 Key removable in 0 position	■	3 — 4	PQ01SCN8DOC	200	1	

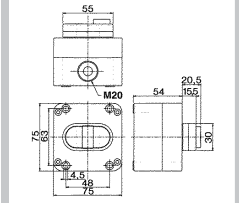

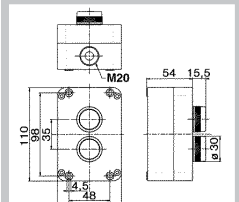
# Pegasus

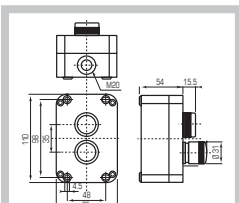
## Push button stations

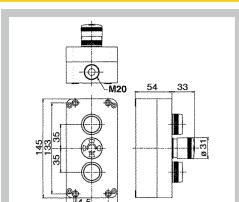
IP65 □ Screw terminal contact blocks

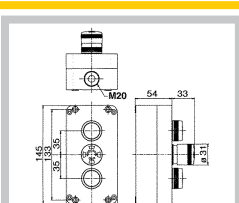
	DESCRIPTION	COL.	DESIGNATION	REF.NO.	WEIGHT g	MIN. PACK QTY.	DIMENSIONS
	Dual push button		3 — 4 1 — 2	PQ01PDN	184	1	
	Dual push button with lens		3 — 4 X1 — X2 1 — 2	PQ01PDL			
	Triple push button		3 — 4 1 — 2 3 — 4	PQ01PMN	186	1	
	With No. 2 push buttons		3 — 4 3 — 4	PQ02B	264	1	
	With No. 1 push button and No. 1 EN418 emergency stop		3 — 4 1 — 2	PQ02A	264	1	
	With No. 1 push button, No. 1 EN418 emergency stop and pilot light		3 — 4 1 — 2 X1 — X2	PQ03A	350	1	
	With No. 2 push buttons and No. 1 EN418 emergency stop		3 — 4 1 — 2 3 — 4	PQ03B	362	1	





# Pegasus

## Push button station enclosures

IP65 □

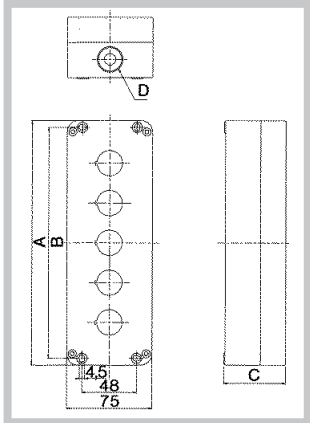

TECHNO-CONTROL EQUIPMENT

DESCRIPTION	REF.NO.		WEIGHT g	MIN. PACK QTY.	DIMENSIONS
	FRONT COVER COLOUR				
 1 hole enclosure			134	1	
	<b>PQ01K</b>	PQ01KGN			
 2 holes enclosure	<b>PQ02K</b>	PQ02KGN	174	1	
	<b>PQ03K</b>	PQ03KGN	214	1	
 3 holes enclosure	<b>PQ04K</b>	PQ04KGN	256	1	
	<b>PQ05K</b>	PQ05KGN	296	1	

HOLE No.	A	B	C	D
1	75	63	54	1xM16 1xM20
2	110	98	54	2xM20
3	145	133	54	2xM20
4	180	168	57	2xM20
5	215	203	54	2xM20



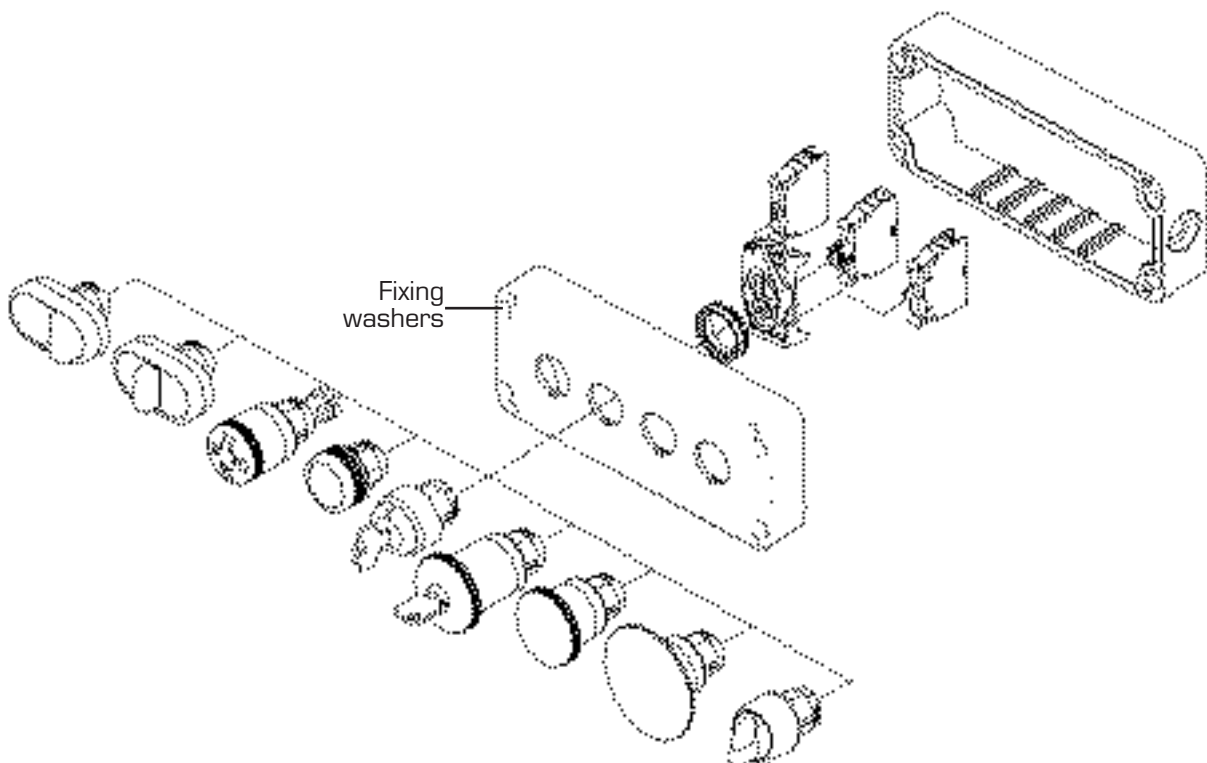

# Pegasus

## Control auxiliaries

### Pneumatic valve adapters

Pegasus control auxiliaries are suitable for operating certain type of pneumatic or micro valves. Push buttons can be used for such applications using a set of adapters and supports.

The operators suitable for this use are the following:

- Standard push buttons with colour cap
- Mushroom operators
- Rotary and key operators

Adapters are supplied with an actuator to operate the pneumatic valve.



#### ASSEMBLY:

Operator  
+Support  
+valve

	DESCRIPTION	REFERENCE NO.	WEIGHT Gr.	MIN. PACK QTY.	DIMENSIONS
	Single adapter (for 1 valve) <b>1</b>	AVP1	5	10	
	Twin adapter (for 2 valves) <b>1</b>	AVP2	10	10	

### 3/2 NC - 3/2 NO MICROVALVE - 2÷10 BAR



BOTTOM  
ø 4 CABLE ENTRY

3/2 NC

3/2 NA

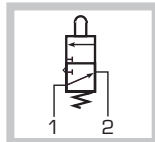
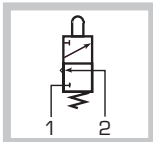

REFERENCE NO.  
V304MA

REFERENCE NO.  
V314MA



SIDE  
ø 4 CABLE ENTRY

3/2 NC

3/2 NA

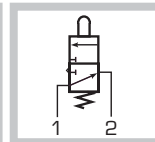
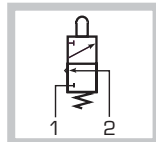

REFERENCE NO.  
V304MAL

REFERENCE NO.  
V314MAL



TAPPED M5 BOTTOM  
CABLE ENTRY

3/2 NC

3/2 NA

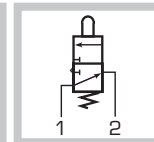
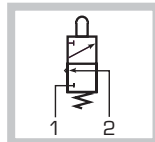

REFERENCE NO.  
V305MA

REFERENCE NO.  
V315MA

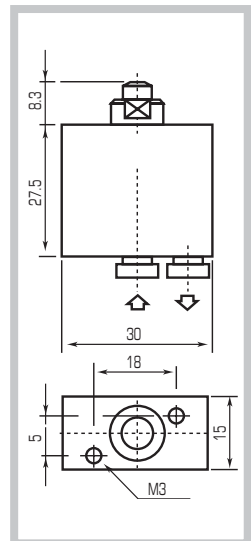

**1** Complete with actuator to operate the valve or valves/To be installed in the centre of the operator

# Pegasus

## Control auxiliaries

### Accessories



TECHNO-CONTROL EQUIPMENT

#### DIN-RAIL ADAPTER

For 53x45 mm distribution boards  
3 DIN modules  
RAL7035 grey colour  
Weight 21 g.  
Min. packing qty. 10 pcs.



11708351

#### EMERGENCY STOP RING

Ø 60  
Made of plastic  
Yellow background  
black letters  
Weight 3.5 g.  
Min. packing qty. 10 pcs.



TEXT	REF.NO.
Blank	PTE
STOP EMERGENZA	PTE/I
EMERGENCY STOP	PTE/A
NOT AUS	PTE/D

#### COUPLING PLATE



PPELN8

#### SEALING CAPS



FOR PCR FLUSH PUSH BUTTONS

PCR



FOR PCS EXTENDED PUSH BUTTONS

PCS



FOR MULTI-FUNCTION

TYPE	REF.NO.
PPDN-PPDL-PPDNCL-PPDLCL	PCD
PPMN-PPMNCL	PCM
PPDNR-PPDLR-PPDNRL-PPDLRCL	PCN

#### CENTRAL CONTACT ACTUATOR

(selectors not included)



PAC

#### MOUNTING RING AND LAMP REMOVAL TOOL



PCF

#### Ø 22.5 HOLE PLUG



PTRN8

#### LEGEND PLATE



PPTN8

#### LABEL



TEXT	REF.NO.
(Blank)	PTA00
MARCIA	PTA01
ARRESTO	PTA02

I O II	PTA03	EIN	PTA12
O I	PTA04	AUS	PTA13
I → O ← II	PTA17	STOP	PTA14
CHIUDE	PTA05	START	PTA15
APRE	PTA06	RESET	PTA16
EMERGENZA	PTA07	AUT O MAN	PTA18
MANUALE	PTA08	INS. - DISINS.	PTA26
AUTOMATICO	PTA09	HAND OFF AUTO	PTA27
AVANTI	PTA10	FORW OFF REV	PTA28
INDIETRO	PTA11	ON OFF	PTA29

#### FASTON AND PCB TERMINALS



FASTON	PCB
6,3x0,8	
11708341	11708235

# Pegasus

## Control auxiliaries

With engraved caps



Black

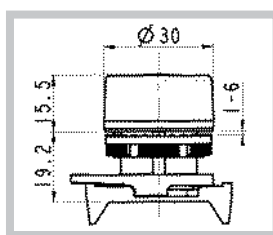

Chrome

SYMBOL	COLOUR AND TYPE	BLACK FRONT RING	CHROME FRONT RING	WEIGHT g.	MIN. PACK QTY.
	Green flush push button	PPRN2/I	PPRN2CL/I	30	10
	Red flush push button	PPRN1/O	PPRN1CL/O	30	10
	Green flush push button	PPRN2/II	PPRN2CL/II	30	10
	Green flush push button	PPRN2/START	PPRN2CL/ START	30	10
	Red flush push button	PPRN1/STOP	PPRN1CL/ STOP	30	10
	Green flush push button	PPRN2/ON	PPRN2CL/ ON	30	10

# Pegasus

## Control auxiliaries

With engraved caps



TECHNO-CONTROL EQUIPMENT



Black

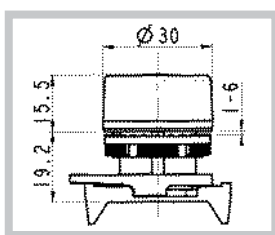

Chrome



SYMBOL	COLOUR AND TYPE	BLACK FRONT RING	CHROME FRONT RING	WEIGHT g.	MIN. PACK QTY.
	Red flush push button	PPRN1/OFF	PPRN1CL/OFF	30	10
	White flush push button	PPRN5/F	PPRN5CL/F	30	10
	Black flush push button	PPRN8/F	PPRN8CL/F	30	10
	Green flush push button	PPRN2/EIN	PPRN2CL/EIN	30	10
	Red flush push button	PPRN1/AUS	PPRN1CL/AUS	30	10

# Pegasus

## Technical data

### Electrical characteristics

#### CONTACT BLOCKS

##### IEC/EN 60947-5-1 CHARACTERISTICS

Rated insulation voltage $U_i$	V
Rated impulse withstand voltage $U_{imp}$	kV
Operating frequency	Hz
Rated thermal current $I_{th}$	A
Rated thermal current enclosed $I_{the}$	A

##### PLO04001 - PLO04002

Rated insulation voltage $U_i$	690 V*
Rated impulse withstand voltage $U_{imp}$	4*
Operating frequency	50/60*
Rated thermal current $I_{th}$	16*
Rated thermal current enclosed $I_{the}$	10*

##### PCW01-PCW10 PSC01-PSC10

Rated insulation voltage $U_i$	690 V*
Rated impulse withstand voltage $U_{imp}$	4*
Operating frequency	50/60*
Rated thermal current $I_{th}$	16*
Rated thermal current enclosed $I_{the}$	10*

##### RATED OPERATING CURRENT $I_e$ :

AC15: alternate current	V
	A
DC13: direct current	V
	A

24	60	110	230	400	440	500	690
16*	12	8	6	4,5	3,5	1*	1
24	48	60	110	220			
2*	1.2	0.85	0.4	0.25*			

24	60	110	240	400	440	500	690
16*	12*	5	5*	4	4	4*	2*
24	48	60	110	250			
2	2*	1*	0.4	0.4*			

Conditional short circuit withstand current	A
Fuse rating gG	500 V
Contact insulation resistance	mΩ
Switching mechanism	
Contact duty	
Minimum tripping force	mil./cycles
Electrical life AC15	

Conditional short circuit withstand current	1000*
Fuse rating gG	10A*
Contact insulation resistance	<25
Switching mechanism	Slow break double gap contacts
Contact duty	NC contact with positive opening ⊕
Minimum tripping force	4N
Electrical life AC15	1A/1.5 - 2A/0.5 - 3A/0.25

Conditional short circuit withstand current	1000*
Fuse rating gG	10A*
Contact insulation resistance	<25
Switching mechanism	Slow break double gap contacts
Contact duty	NC contact with positive opening ⊕
Minimum tripping force	4N
Electrical life AC15	1A/1.5 - 2A/0.5 - 3A/0.25

##### UL 508 CHARACTERISTICS

General use	
Heavy Duty (HD) category	

General use	10A-600V ac 2.5A-125V dc
Heavy Duty (HD) category	A600-Q600

General use	10A-600V ac 2.5-125V dc
Heavy Duty (HD) category	A600-Q600

#### LED PILOT LAMP

##### IEC/EN 60947-5-1 CHARACTERISTICS

Rated insulation voltage $U_i$ AC/DC	V
Rated insulation voltage $U_i$ AC	V
Operating frequency	Hz
Current $I_e$	mA
Brightness	cd/m <sup>2</sup>
Electrical life	h

##### LED PLML.L

Rated insulation voltage $U_i$ AC/DC	6 - 12 - 24 - 28
Rated insulation voltage $U_i$ AC	110 - 220 - 380
Operating frequency	50/60
Current $I_e$	≤80 (6V - 12V) - ≤20 (24V...380V)
Brightness	≤60
Electrical life	≤30.000

##### BA9s - E10 PLML.

Rated insulation voltage $U_i$ AC/DC	250
Rated insulation voltage $U_i$ AC	-
Operating frequency	50/60
Current $I_e$	2 W max
Brightness	-
Electrical life	-

#### POWER SUPPLIES

##### IEC/EN 60947-5-1 CHARACTERISTICS

Rated insulation voltage $U_i$	V
Rated operating voltage $U_e$	V
	V
	V
	V
Max rated power	W
Power supply	
Lamp fixing system	

##### DIRECT PLO04007 PCWAD-PSCAD

Rated insulation voltage $U_i$	690*
Rated operating voltage $U_e$	400* 300 <sup>1</sup>
	-
	-
	-
Max rated power	2.4* 2.5 <sup>1</sup>
Power supply	AC/DC
Lamp fixing system	BA9s

##### LED PLO04.L. PCWL.L.-PSC.,.

Rated insulation voltage $U_i$	400
Rated operating voltage $U_e$	AC/DC 12-24
	AC/DC 48
	AC/DC 110
	AC 220
Max rated power	-
Power supply	-
Lamp fixing system	-

##### RESISTOR PLO04RD.

Rated insulation voltage $U_i$	400
Rated operating voltage $U_e$	PRIMARY SECONDARY
	110/130 48/60
	220/240 110/130
	- -
Max rated power	2
Power supply	-
Lamp fixing system	BA9s

##### TRANSFORMER PLO04TR.

Rated insulation voltage $U_i$	440
Rated operating voltage $U_e$	PRIMARY SECONDARY
	110/130 24
	220/240 24
	380/440 24
Max rated power	1.5
Power supply	AC
Lamp fixing system	BA9s

##### FLASHING LIGHT PLO04LA.

Rated insulation voltage $U_i$	400
Rated operating voltage $U_e$	PRIMARY SECONDARY
	24 24
	110/130 110/130
	- -
Max rated power	2,6
Power supply	-
Lamp fixing system	BA9s

<sup>1</sup> UL certified values

\* IMG certified values

# Pegasus

## Technical data

### General characteristics



TECHNO-CONTROL EQUIPMENT

STANDARD CONFORMITY		
■ Approvals		UL, IMQ, CCC, GOST-R, R.I.NA
■ Protection class	EN60529	IEC947-5-1, EN60947-5-1, UL508
		IP65: push buttons, rotary switches
		IP65: mushroom operators
		IP65: pilot lights
		IP66: push buttons with sealing cap
		IP40: multi-function push buttons
		IP65: push button stations
		IP20: contact blocks with spring or screwless terminals
		IPO0: contact blocks with welding terminals
■ Material group	EN60947-1	II
■ Pollution grade	EN60947-1	3
■ Flammability	UL94	VO: live parts
■ Ambient temperature	°C	Operating: -25 +70
	°C	Storage: -30 +70
■ Climate protection	IEC68 part 2-3	Hot damp
	IEC68 part 2-30	Unsettled hot damp
Terminals referencing:		EN50013
■ Terminals:		
Dimensions		A2
Screw		M3,5
Torque		1.2Nm - EN60947-1 - 12 lb.in. UL508
■ Capacity:		
solid and flexible conductors	No. 1 min/max mm <sup>2</sup>	1/2.5 screw terminals, 0.5-2.5 spring loaded terminals
	No. 2 min/max mm <sup>2</sup>	1/2.5 screw terminals, 0.5-2.5 spring loaded terminals
	AWG	20-12 screw terminals
■ Mechanical life:		
Mushroom operators and standard		
Push buttons with colour cap	mil./cycles	3
Standard push buttons with lens cap		1
Latched push button with colour cap		1
Standard rotary switches		1
Rotary switches with lens, latched		
pushbutton with lens cap, joysticks		0.5
Emergency stop push buttons with release		0.3



# Limit Switches

FA - FT - FT1R - Safety - FCT - Astra Series

Table of contents



TECHNO-CONTROL EQUIPMENT



Thermoplastic and die-cast aluminium limit switches



Limit switches with reset



Safety limit switches



Pre-wired thermoplastic limit switches

## TABLE OF CONTENTS

■ Introduction	pag. 72	■ Installation and use	pag. 91
■ FA series limit switches	pag. 74	■ Technical data	pag. 92
■ FT series limit switches	pag. 80	■ FCT series limit switches Pre-wired	pag. 93
■ Safety limit switches with reset	pag. 87	■ Astra universal limit switches	pag. 94
■ Safety limit switches	pag. 89		



# Limit Switches

## FA - FT - FT1R - Safety - FCT - Astra Series Terminology

### DOUBLE INSULATION □

Materials of group II, according to IEC536, are made with double insulation. This consists of doubling the insulation capability by means

of an additional divider in order to eliminate any electrical shock risk and avoid the need for any additional protections.

### POSITIVE OPENING OPERATION ⊕

A limit switch complies to this specification when all the normally closed contact elements of the switch can be changed, with certainty, to the open position (no flexible link between the moving contacts and the operator of the switch, to which an actuating force is applied). Positive opening does not apply to NO contacts. Control switches

with positive opening operation can be equipped with either slow-break or snap-action contacts. In order to use different contacts on the same switch, it is necessary to electrically separate them; otherwise only one contact can be used. Every positive opening control switch must be marked on the external housing with the symbol ⊕.

### SNAP-ACTION CONTACTS

Snap action contacts are characterised by different tripping and resetting points (differential travel). The displacement speed of the moving contacts is independent to the speed of the operator. This feature ensures satisfactory electrical performance in applications involving low speed actuators.

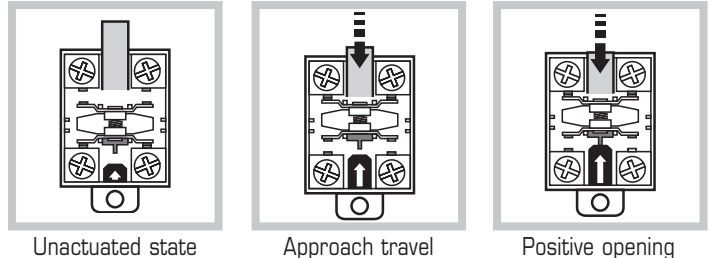

Unactuated state

Approach travel

Positive opening

### SLOW-BREAK CONTACTS

Slow break contacts are characterised by identical tripping and resetting points. The displacement speed of the moving contacts is equal, or proportional, to the speed of the operator. The opening distance is also dependent on the distance travelled by the operator.

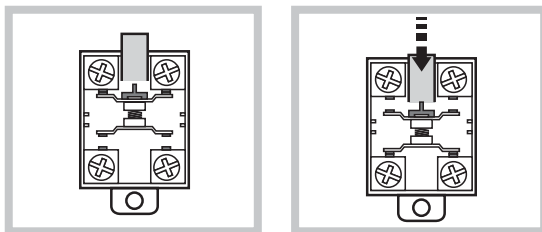

Contact in stand-by

Contact activated

### CONTACT BLOCKS CONFIGURATION

ACCORDING TO IEC/EN60947-5-1

Contact blocks with 4 terminals must be marked with Za or Zb symbols as shown in the picture below.

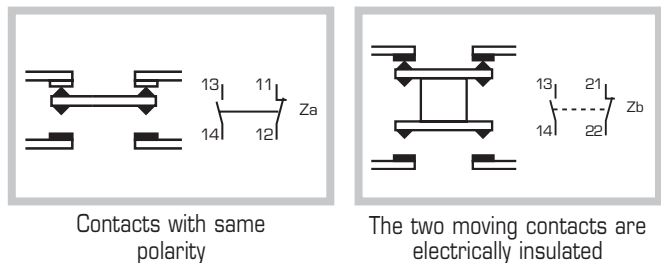

Contacts with same polarity

The two moving contacts are electrically insulated

### APPLICATIONS

**AC-15:** control of an electromagnet on a.c., test 10 le/le.

**AC-13:** control of an electromagnet on d.c., test le/le.

### TERMINALS

For limit switches with metal housing, the fixing point of the earth conductor must be marked and must be positioned inside the housing next to the cable entry.

# Limit Switches

FA - FT - FT1R - Safety - FCT - Astra Series  
Terminology



TECHNO-CONTROL EQUIPMENT

## MINIMUM OPENING FORCE/MOMENTUM

It is the minimum force/momentum that must be applied by the actuator for the contacts to trip.

## MINIMUM POSITIVE OPENING FORCE/MOMENTUM

It is the minimum force/momentum that must be applied by the actuator to guarantee the positive opening of NC contacts.

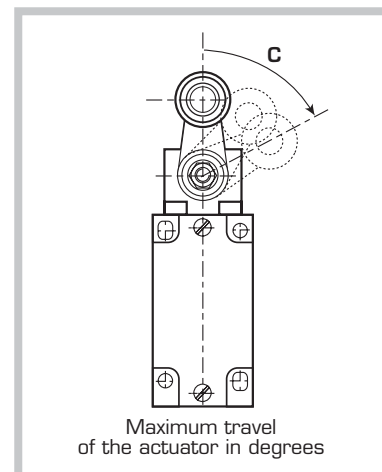
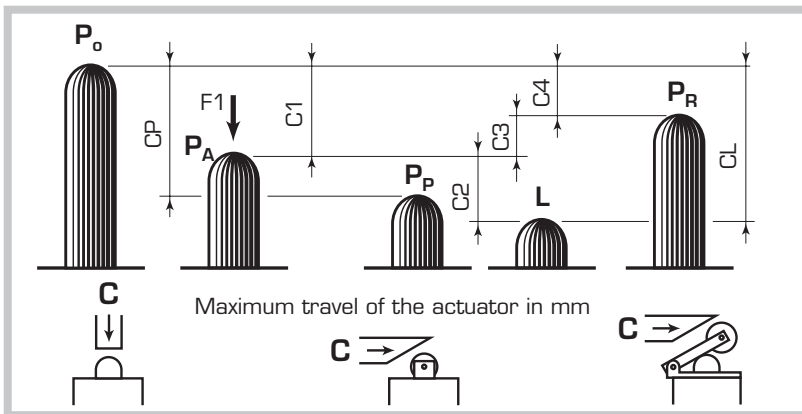

- P<sub>0</sub>** Rest position  
Position of the actuator when no external force is applied.
- P<sub>A</sub>** Tripping point of contact  
Position of the actuator, with force F1 applied, in which the contacts leave the stand-by position.
- P<sub>P</sub>** Positive opening position  
Position of the actuator when there is positive opening.
- L** Maximum travel position  
Maximum travel of the actuator when the force F1 is applied.
- P<sub>R</sub>** Resetting position  
Position of the actuator when the contacts are back in their non actuated position.

- C<sub>1</sub>** Tripping travel  
Distance between the P<sub>0</sub> and P<sub>A</sub> positions.
- C<sub>P</sub>** Positive opening tripping travel  
Minimum travel of the actuator from the P<sub>0</sub> position to guarantee positive opening of NC contacts.
- C<sub>2</sub>** Extra tripping travel  
Distance between P<sub>A</sub> and the maximum travel L.
- C<sub>L</sub>** Maximum travel  
Distance between P<sub>0</sub> and the maximum travel L.
- C<sub>3</sub>** Differential travel (C<sub>1</sub>-C<sub>4</sub>)  
Distance between P<sub>A</sub> and P<sub>R</sub>
- C<sub>4</sub>** Resetting travel  
Distance between P<sub>R</sub> and P<sub>0</sub>

### Tripping travel for snap-action contacts

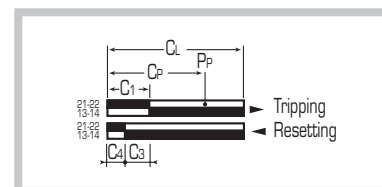

### Tripping travel for slow-break contacts

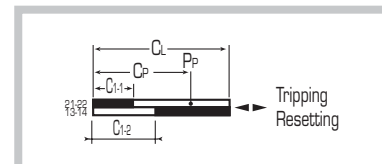

NOTE: for slow-break contacts, C<sub>3</sub>=C<sub>1</sub>, C<sub>1</sub>-1=Tripping and resetting travel of contacts 21-22, C<sub>1</sub>-2=Tripping and resetting travel of contacts 13-14

### Examples

**FA134Z11**  
(snap-action contacts)



Tripping travel in mm/  
cam linear movement



**FA138Z11**  
(snap-action contacts)



Tripping travel in degrees/  
lever rotary movement

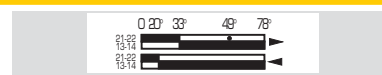

**FA131X11**  
(slow break contacts)



Tripping travel in mm/  
plunger linear movement

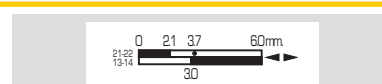

# Limit Switches

## FA1 Series

IP66 die-cast aluminium type

1 cable entry  
M16x1.5



FA131



FA134



FA132



FA133

TYPE OF OPERATOR	SHORT STEEL END PLUNGER	STEEL ROLLER PLUNGER	PA ROLLER LEVER PLUNGER HORIZONTAL ACTUATION	PA ROLLER LEVER PLUNGER VERTICAL ACTUATION
Standard - Positive opening NC contacts	EN50047	EN50047	-	-
Minimum tripping force	15	12	7	7
Minimum positive opening force	30	30	24	24
<b>Z11</b> 1NC-1NO Zb	FA131Z11 	FA134Z11 	FA132Z11 	FA133Z11 
<b>X11</b> 1NC-1NO Zb	FA131X11 	FA134X11 	FA132X11 	FA133X11 
<b>Y11</b> 1NC-1NO overlapping Zb	FA131Y11 	FA134Y11 	FA132Y11 	FA133Y11 
<b>Z02</b> 2NC Zb	FA131Z02 	FA134Z02 	FA132Z02 	FA133Z02 
<b>W02</b> 2NC Zb	FA131W02 	FA134W02 	FA132W02 	FA133W02 
<b>W20</b> 2NO Zb	FA131W20 	FA134W20 	FA132W20 	FA133W20 
<b>WEIGHT gr. - MIN. PACK QTY.</b>	168 gr. 1 pcs.	175 gr. 1 pcs.	186 gr. 1 pcs.	186 gr. 1 pcs.
<b>DIMENSIONS</b>				

# Limit Switches

## FA1 Series

IP66 die-cast aluminium type



TECHNO-CONTROL EQUIPMENT

1 cable entry  
M16x1.5



FA138



FA141



FA139



FA140

TYPE OF OPERATOR	18 Ø PA ROLLER LEVER	50 Ø RUBBER ROLLER LEVER	VARIABLE LENGTH 18 Ø PA ROLLER LEVER	VARIABLE LENGTH 50 Ø RUBBER ROLLER LEVER
Standard - Positive opening NC contacts	-	-	-	-
Minimum tripping force	0.10	0.10	0.10	0.10
Minimum positive opening force	0.32	-	-	-
<b>Z11</b> Snap action 1NC-1NO Zb	FA138Z11 	FA141Z11 	FA139Z11 	FA140Z11 
<b>X11</b> Slow break 1NC-1NO Zb	FA138X11 	FA141X11 	FA139X11 	FA140X11 
<b>Y11</b> Slow break 1NC-1NO overlapping Zb	FA138Y11 	FA141Y11 	FA139Y11 	FA140Y11 
<b>Z02</b> Snap action 2NC Zb	FA138Z02 	FA141Z02 	FA139Z02 	FA140Z02 
<b>W02</b> Slow break 2NC Zb	FA138W02 	FA141W02 	FA139W02 	FA140W02 
<b>W20</b> Slow break 2NO Zb	FA138W20 	FA141W20 	FA139W20 	FA140W20 

WEIGHT gr. - MIN. PACK QTY.

235 gr. 1 pcs.

255 gr. 1 pcs.

245 gr. 1 pcs.

265 gr. 1 pcs.

### DIMENSIONS

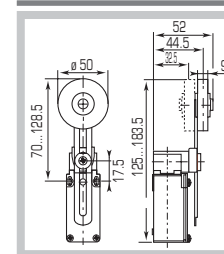
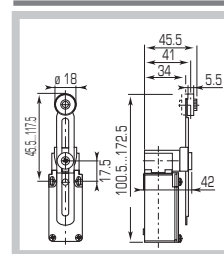
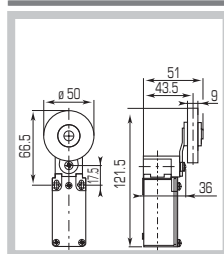
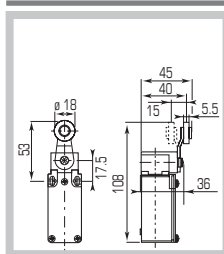
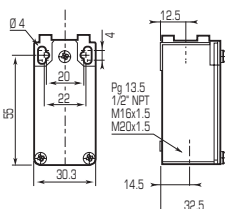

# Limit Switches

## FA1 Series

IP66 die-cast aluminium type

1 cable entry  
M16x1.5



FA135



FA136



FA137

TYPE OF OPERATOR	SPRING LEVER WITH TIP IN PA	"CAT'S WHISKER"	3 Ø STEEL ROD LEVER
Standard - Positive opening NC contacts (→)	-	-	-
Minimum tripping force	0.10	0.10	0.10
Minimum positive opening force	-	-	-
<b>Z11</b> Snap action 1NC-1NO Zb	FA135Z11 	FA136Z11 	FA137Z11 
<b>X11</b> Slow break 1NC-1NO Zb	FA135X11 	FA136X11 	FA137X11 
<b>Y11</b> Slow break 1NC-1NO overlapping Zb	FA135Y11 	FA136Y11 	FA137Y11 
<b>Z02</b> Snap action 2NC Zb	FA135Z02 	FA136Z02 	FA137Z02 
<b>W02</b> Slow break 2NC Zb	FA135W02 	FA136W02 	FA137W02 
<b>W20</b> Slow break 2NO Zb	FA135W20 	FA136W20 	FA137W20 

WEIGHT gr. - MIN. PACK QTY.

235 gr. 1 pcs.

255 gr. 1 pcs.

245 gr. 1 pcs.

### DIMENSIONS

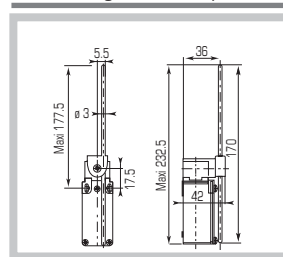
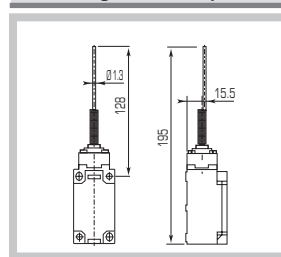
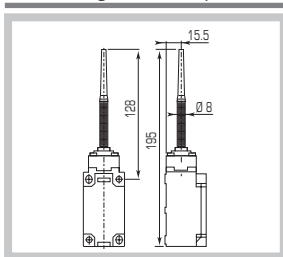
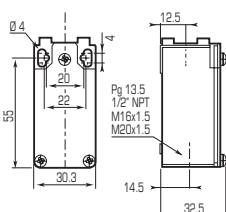

# Limit Switches

## FA3 Series

IP66 die-cast aluminium type



TECHNO-CONTROL EQUIPMENT

3 cable entries  
M16x1.5



FA331



FA334



FA332

TYPE OF OPERATOR	SHORT STEEL END PLUNGER	SHORT STEEL ROLLER PLUNGER	PA ROLLER LEVER PLUNGER HORIZONTAL ACTUATION
Standard - Positive opening NC contacts	-	-	-
Minimum tripping force	15	12	7
Minimum positive opening force	30	30	24
<b>Z11</b> Snap action 1NC-1NO Zb	FA331Z11 	FA334Z11 	FA332Z11 
<b>X11</b> Slow break 1NC-1NO Zb	FA331X11 	FA334X11 	FA332X11 
<b>Y11</b> Slow break 1NC-1NO overlapping Zb	FA331Y11 	FA334Y11 	FA332Y11 
<b>Z02</b> Snap action 2NC Zb	FA331Z02 	FA334Z02 	FA332Z02 
<b>W02</b> Slow break 2NC Zb	FA331W02 	FA334W02 	FA332W02 
<b>W20</b> Slow break 2NO Zb	FA331W20 	FA334W20 	FA332W20 

WEIGHT gr. - MIN. PACK QTY.

270 gr. 1 pcs.

280 gr. 1 pcs.

290 gr. 1 pcs.

### DIMENSIONS

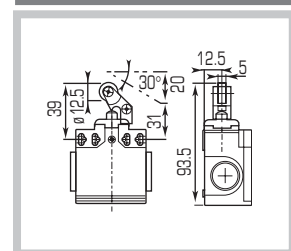
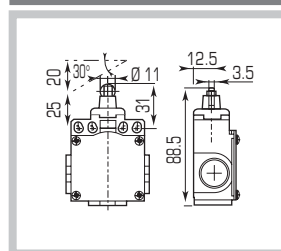
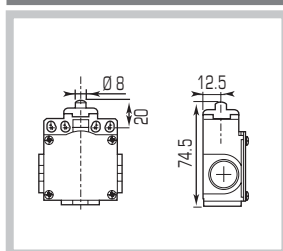
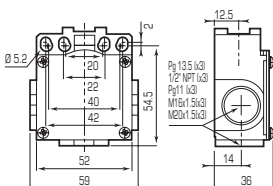

# Limit Switches

## FA3 Series

IP66 die-cast aluminium type

3 cable entries  
M16x1.5



FA338



FA341



FA339



FA340

TYPE OF OPERATOR	18 Ø PA ROLLER LEVER	50 Ø RUBBER ROLLER LEVER	VARIABLE LENGTH 18 Ø PA ROLLER LEVER	VARIABLE LENGTH 50 Ø RUBBER ROLLER LEVER
Standard - Positive opening NC contacts	-	-	-	-
Minimum tripping force	0.10	0.10	0.10	0.10
Minimum positive opening force	0.32	-	-	-
<b>Z11</b> Snap action 1NC-1NO	FA338Z11 	FA341Z11 	FA339Z11 	FA340Z11 
<b>X11</b> Slow break 1NC-1NO	FA338X11 	FA341X11 	FA339X11 	FA340X11 
<b>Y11</b> Slow break overlapping 1NC-1NO	FA338Y11 	FA341Y11 	FA339Y11 	FA340Y11 
<b>Z02</b> Snap action 2NC	FA338Z02 	FA341Z02 	FA339Z02 	FA340Z02 
<b>W02</b> Slow break 2NC	FA338W02 	FA341W02 	FA339W02 	FA340W02 
<b>W20</b> Slow break 2NO	FA338W20 	FA341W20 	FA339W20 	FA340W20 
<b>WEIGHT gr. - MIN. PACK QTY.</b>	325 gr. 1 pcs.	345 gr. 1 pcs.	335 gr. 1 pcs.	355 gr. 1 pcs.

### DIMENSIONS

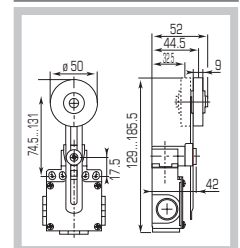
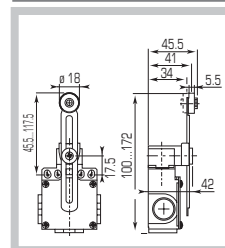
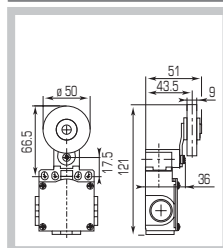
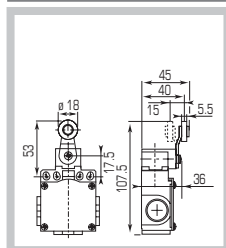
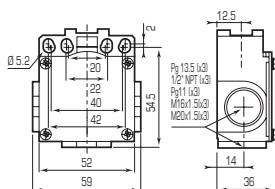

# Limit Switches

## FA3 Series

IP66 die-cast aluminium type



TECHNO-CONTROL EQUIPMENT

3 cable entries  
M16x1.5



FA335



FA336



FA337

TYPE OF OPERATOR	SPRING LEVER WITH TIP IN PA	"CAT'S WHISKER"	VARIABLE LENGTH 3 Ø STEEL ROD LEVER
Standard - Positive opening NC contacts	-	-	-
Minimum tripping force	0.10	0.10	0.10
Minimum positive opening force	-	-	-
<b>Z11</b> 1NC-1NO Snap action  Zb	<b>FA335Z11</b> 	<b>FA336Z11</b> 	<b>FA337Z11</b> 
<b>X11</b> 1NC-1NO Slow break  Zb	<b>FA335X11</b> 	<b>FA336X11</b> 	<b>FA337X11</b> 
<b>Y11</b> 1NC-1NO Slow break overlapping  Zb	<b>FA335Y11</b> 	<b>FA336Y11</b> 	<b>FA337Y11</b> 
<b>Z02</b> 2NC Snap action  Zb	<b>FA335Z02</b> 	<b>FA336Z02</b> 	<b>FA337Z02</b> 
<b>W02</b> 2NC Slow break  Zb	<b>FA335W02</b> 	<b>FA336W02</b> 	<b>FA337W02</b> 
<b>W20</b> 2NO Slow break  Zb	<b>FA335W20</b> 	<b>FA336W20</b> 	<b>FA337W20</b> 

WEIGHT gr. - MIN. PACK QTY.

305 gr. 1 pcs.

320 gr. 1 pcs.

380 gr. 1 pcs.

**DIMENSIONS**

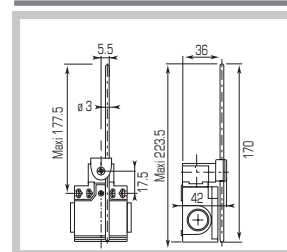
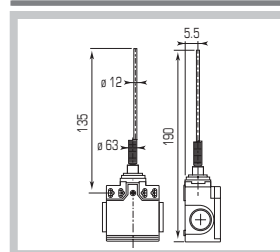
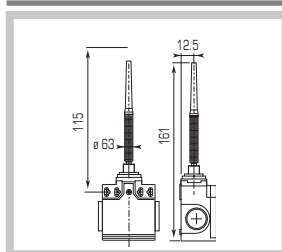
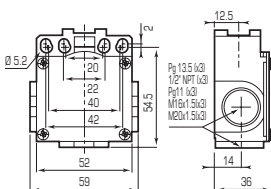



# Limit Switches

## FT1 Series

IP65 □ thermoplastic type

1 cable entry  
M16x1.5



FT131



FT1P31



FT134



FT132

TYPE OF OPERATOR	SHORT STEEL END PLUNGER	SHORT STEEL END PLUNGER WITH PROTECTIVE BOOT	PA ROLLER LEVER PLUNGER	PA ROLLER LEVER PLUNGER HORIZONTAL ACTUATION
Standard - Positive opening NC contacts (→)	EN50047 (→)	EN50047 (→)	EN50047 (→)	EN50047 (→)
Minimum tripping force	15	15	12	7
Minimum positive opening force	30	30	30	24
<b>Z11</b> Snap action 1NC-1NO 13 21 14 22 Zb	FT131Z11 0 13 25 41 56 mm	FT1P31Z11 0 13 25 41 56 mm	FT134Z11 0 25 47 76 96 mm	FT132Z11 0 49 90 145 210 mm
<b>X11</b> Slow break 1NC-1NO 13 21 14 22 Zb	FT131X11 0 16 32 56 mm 2.5	FT1P31X11 0 16 32 56 mm 2.5	FT134X11 0 32 60 96 mm 46	FT132X11 0 60 105 210 mm 86
<b>Y11</b> Slow break 1NC-1NO overlapping 13 21 14 22 Zb	FT131Y11 0 29 45 56 mm 15	FT1P31Y11 0 29 45 56 mm 15	FT134Y11 0 53 82 96 mm 30	FT132Y11 0 102 146 210 mm 54
<b>Z02</b> Snap action 11 21 12 22 Zb	FT131Z02 0 13 24 40 56 mm	FT1P31Z02 0 13 24 40 56 mm	FT134Z02 0 25 45 74 96 mm	FT132Z02 0 51 86 131 210 mm
<b>W02</b> Slow break 11 21 12 22 Zb	FT131W02 0 15 31 56 mm	FT1P31W02 0 15 31 56 mm	FT134W02 0 30 59 96 mm	FT132W02 0 57 102 210 mm
<b>W20</b> Slow break 13 23 14 24 Zb	FT131W20 0 14 56 mm	FT1P31W20 0 14 56 mm	FT134W20 0 28 96 mm	FT132W20 0 5.3 210 mm
<b>WEIGHT gr. - MIN. PACK QTY.</b>	60 gr. 1 pcs.	60 gr. 1 pcs.	62 gr. 1 pcs.	65 gr. 1 pcs.

DIMENSIONS	FT131	FT1P31	FT134	FT132
<p>Dimensions for FT131: 22, 20, 24.5, 12.5, 15, 30, 30.3, 63, Pg 13.5, Pg 11, M16x1.5, M20x1.5</p>	<p>Dimensions for FT1P31: Ø8, 12.5, 73</p>	<p>Dimensions for FT134: Ø8, 12.5, 73</p>	<p>Dimensions for FT132: 30, Ø11, 12.5, 3.5, 39, Ø12.5, 31, 20, 92, 12.5, 5</p>	

# Limit Switches

## FT1 Series

IP65 □ thermoplastic type



TECHNO-CONTROL EQUIPMENT

1 cable entry  
M16x1.5



FT1P32



FT133



FT1P33



FT138

TYPE OF OPERATOR	PA ROLLER LEVER PLUNGER WITH PROTECTIVE BOOT HORIZONTAL ACTUATION	PA ROLLER LEVER PLUNGER VERTICAL ACTUATION	PA ROLLER LEVER PLUNGER WITH PROTECTIVE BOOT VERTICAL ACTUATION	18 Ø PA ROLLER LEVER
Standard - Positive opening NC contacts (→)	EN50047 (→)	EN50047 (→)	EN50047 (→)	EN50047 (→)
Minimum tripping force	N	7	7	0.10
Minimum positive opening force	N	24	24	0.32
<b>Z11</b> Snap action 1NC-1NO	FT1P32Z11 0 49 90 145 210 mm	FT133Z11 0 49 90 145 210 mm	FT1P33Z11 0 49 90 145 210 mm	FT138Z11 0 17° 31° 47° 74°
<b>X11</b> Slow break 1NC-1NO	FT1P32X11 0 60 105 210 mm 86	FT133X11 0 60 105 210 mm 86	FT1P33X11 0 60 105 210 mm 86	FT138X11 0 21° 37° 74° 30°
<b>Y11</b> Slow break 1NC-1NO overlapping	FT1P32Y11 0 102 146 210 mm 54	FT133Y11 0 102 146 210 mm 54	FT1P33Y11 0 102 146 210 mm 54	FT138Y11 0 35° 51° 74° 18°
<b>Z02</b> Snap action 2NC	FT1P32Z02 0 51 86 131 210 mm	FT133Z02 0 51 86 131 210 mm	FT1P33Z02 0 51 86 131 210 mm	FT138Z02 0 17° 30° 46° 74°
<b>W02</b> Slow break 2NC	FT1P32W02 0 57 102 210 mm	FT133W02 0 57 102 210 mm	FT1P33W02 0 57 102 210 mm	FT138W02 0 19° 37° 74°
<b>W20</b> Slow break 2NO	FT1P32W20 0 5.3 210 mm	FT133W20 0 5.3 210 mm	FT1P33W20 0 5.3 210 mm	FT138W20 0 18° 74°
<b>WEIGHT gr. - MIN. PACK QTY.</b>	65 gr. 1 pcs.	65 gr. 1 pcs.	65 gr. 1 pcs.	80 gr. 1 pcs.

### DIMENSIONS

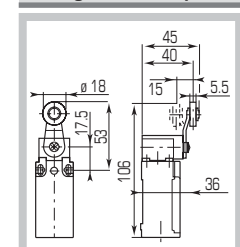
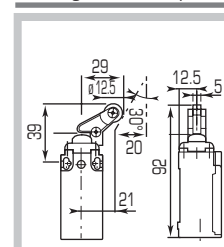
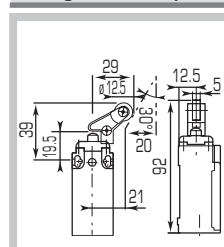
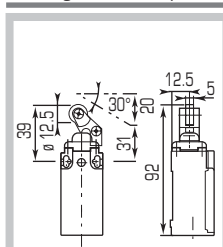
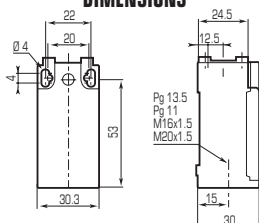

# Limit Switches

## FT1 Series

IP65 □ thermoplastic type

1 cable entry  
M16x1.5



FT141



FT139



FT140



FT135

TYPE OF OPERATOR	50 Ø RUBBER ROLLER LEVER	VARIABLE LENGTH 18 Ø PA ROLLER LEVER	VARIABLE LENGTH 50 Ø RUBBER ROLLER LEVER	SPRING LEVER WITH TIP IN PA
Standard - Positive opening NC contacts	-	-	-	EN50047
Minimum tripping force N	0.10	0.10	0.10	0.12
Minimum positive opening force N	-	-	-	-
<b>Z11</b> Snap action 1NC-1NO	FT141Z11 	FT139Z11 	FT140Z11 	FT135Z11 
<b>X11</b> Slow break 1NC-1NO	FT141X11 	FT139X11 	FT140X11 	FT135X11 
<b>Y11</b> Slow break 1NC-1NO overlapping	FT141Y11 	FT139Y11 	FT140Y11 	FT135Y11 
<b>Z02</b> Snap action 2NC	FT141Z02 	FT139Z02 	FT140Z02 	FT135Z02 
<b>W02</b> Slow break 2NC	FT141W02 	FT139W02 	FT140W02 	FT135W02 
<b>W20</b> Slow break 2NO	FT141W20 	FT139W20 	FT140W20 	FT135W20 

WEIGHT gr. - MIN. PACK QTY.

95 gr. 1 pcs.

105 gr. 1 pcs.

125 gr. 1 pcs.

70 gr. 1 pcs.

### DIMENSIONS

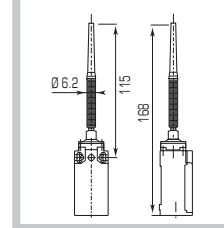
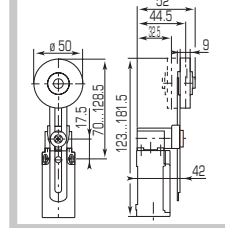
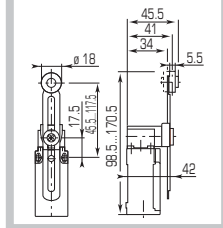
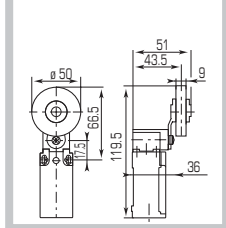
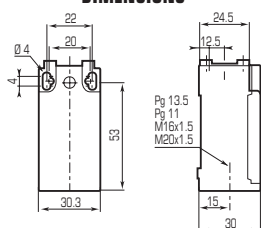

# Limit Switches

## FT1 Series

IP65 □ thermoplastic type



TECHNO-CONTROL EQUIPMENT

1 cable entry  
M16x1.5



FT136



FT137

TYPE OF OPERATOR	"CAT'S WHISKER"	VARIABLE LENGTH 3 Ø STEEL ROD LEVER
Standard - Positive opening NC contacts	-	-
Minimum tripping force N	0.12	0.12
Minimum positive opening force N	-	-
<b>Z11</b> 1NC-1NO Snap action  Zb	<b>FT136Z11</b> 	<b>FT137Z11</b> 
<b>X11</b> 1NC-1NO Slow break  Zb	<b>FT136X11</b> 	<b>FT137X11</b> 
<b>Y11</b> 1NC-1NO Slow break overlapping  Zb	<b>FT136Y11</b> 	<b>FT137Y11</b> 
<b>Z02</b> 2NC Snap action  Zb	<b>FT136Z02</b> 	<b>FT137Z02</b> 
<b>W02</b> 2NC Slow break  Zb	<b>FT136W02</b> 	<b>FT137W02</b> 
<b>W20</b> 2NO Slow break  Zb	<b>FT136W20</b> 	<b>FT137W20</b> 

WEIGHT gr. - MIN. PACK QTY.

80 gr. 1 pcs.

105 gr. 1 pcs.

DIMENSIONS

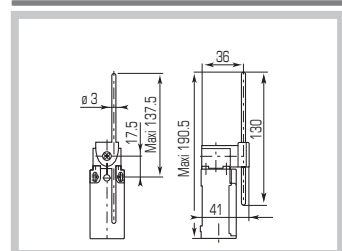
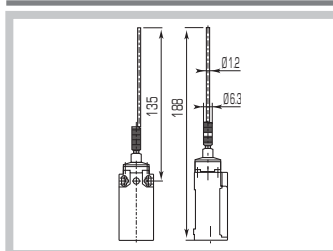
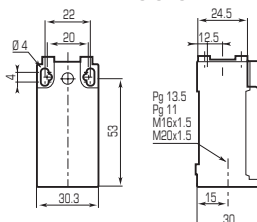

# Limit Switches

## FT2 Series

IP65 □ thermoplastic type

2 cable entries  
M16x1.5



FT231



FT2P31



FT234



FT232

TYPE OF OPERATOR	SHORT STEEL END PLUNGE	SHORT STEEL END PLUNGER WITH PROTECTIVE BOOT	PA ROLLER LEVER PLUNGER	PA ROLLER LEVER PLUNGER HORIZONTAL ACTUATION
Standard - Positive opening NC contacts (→)	- (→)	- (→)	- (→)	- (→)
Minimum tripping force N	15	15	12	7
Minimum positive opening force N	30	30	30	24

Z11 1NC-1NO	Snap action	FT231Z11	FT2P31Z11	FT234Z11	FT232Z11

X11 1NC-1NO	Slow break	FT231X11	FT2P31X11	FT234X11	FT232X11

Y11 1NC-1NO overlapping	Slow break	FT231Y11	FT2P31Y11	FT234Y11	FT232Y11

Z02 2NC	Snap action	FT231Z02	FT2P31Z02	FT234Z02	FT232Z02

W02 2NC	Slow break	FT231W02	FT2P31W02	FT234W02	FT232W02

W20 2NO	Slow break	FT231W20	FT2P31W20	FT234W20	FT232W20

WEIGHT gr. - MIN. PACK QTY.	100 gr. 1 pcs.	100 gr. 1 pcs.	105 gr. 1 pcs.	105 gr. 1 pcs.
-----------------------------	----------------	----------------	----------------	----------------

### DIMENSIONS

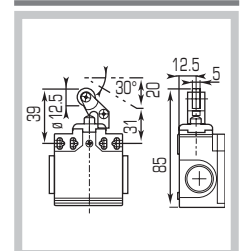
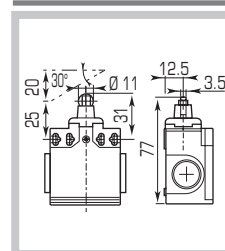
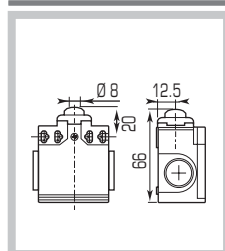
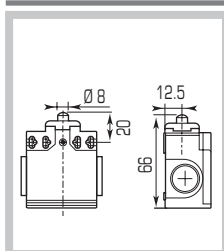
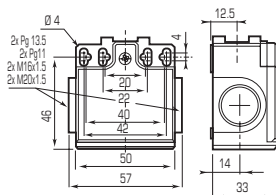

# Limit Switches

## FT2 Series

IP65 □ thermoplastic type



TECHNO-CONTROL EQUIPMENT

2 cable entries  
M16x1.5



FT2P32



FT238



FT239



FT240

TYPE OF OPERATOR	PA ROLLER LEVER PLUNGER WITH PROTECTIVE BOOT HORIZONTAL ACTUATION	18 Ø PA ROLLER LEVER	VARIABLE LENGTH 18 Ø PA ROLLER LEVER	VARIABLE LENGTH 50 Ø RUBBER ROLLER LEVER
Standard - Positive opening NC contacts	-	-	-	-
Minimum tripping force N	7	0.10	0.10	0.10
Minimum positive opening force N	24	0.32	-	-
<b>Z11</b> Snap action 1NC-1NO	FT2P32Z11 	FT238Z11 	FT239Z11 	FT240Z11 
<b>X11</b> Slow break 1NC-1NO	FT2P32X11 	FT238X11 	FT239X11 	FT240X11 
<b>Y11</b> Slow break 1NC-1NO overlapping	FT2P32Y11 	FT238Y11 	FT239Y11 	FT240Y11 
<b>Z02</b> Snap action 2NC	FT2P32Z02 	FT238Z02 	FT239Z02 	FT240Z02 
<b>W02</b> Slow break 2NC	FT2P32W02 	FT238W02 	FT239W02 	FT240W02 
<b>W20</b> Slow break 2NO	FT2P32W20 	FT238W20 	FT239W20 	FT240W20 

WEIGHT gr. - MIN. PACK QTY.

105 gr. 1 pcs. 125 gr. 1 pcs. 125 gr. 1 pcs. 155 gr. 1 pcs.

### DIMENSIONS

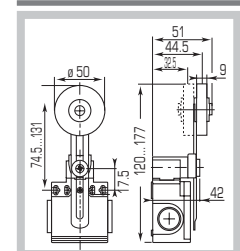
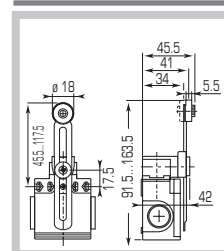
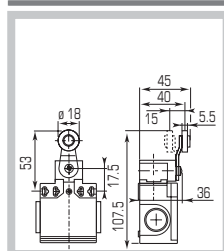
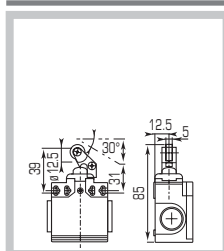
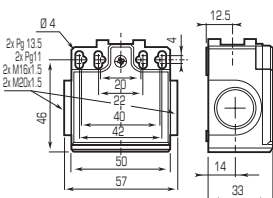

# Limit Switches

## FT2 Series

IP65 □ thermoplastic type

2 cable entries  
M16x1.5



FT241



FT235



FT236



FT237

TYPE OF OPERATOR	50 Ø RUBBER ROLLER LEVER	SPRING LEVER WITH TIP IN PA	"CAT'S WHISKER"	VARIABLE LENGTH 3 Ø STEEL ROD LEVER
Standard - Positive opening NC contacts	-	-	-	-
Minimum tripping force N	0.10	0.10	0.10	0.10
Minimum positive opening force N	-	0.32	-	-
<b>Z11</b> Snap action 1NC-1NO	FT241Z11 	FT235Z11 	FT236Z11 	FT237Z11 
<b>X11</b> Slow break 1NC-1NO	FT241X11 	FT235X11 	FT236X11 	FT237X11 
<b>Y11</b> Slow break 1NC-1NO overlapping	FT241ZY11 	FT235Y11 	FT236Y11 	FT237Y11 
<b>Z02</b> Snap action 2NC	FT241Z02 	FT235Z02 	FT236Z02 	FT237Z02 
<b>W02</b> Slow break 2NC	FT241W02 	FT235W02 	FT236W02 	FT237W02 
<b>W20</b> Slow break 2NO	FT241W20 	FT235W20 	FT236W20 	FT237W20 
<b>WEIGHT gr. - MIN. PACK QTY.</b>	145 gr. 1 pcs.	135 gr. 1 pcs.	110 gr. 1 pcs.	130 gr. 1 pcs.

### DIMENSIONS

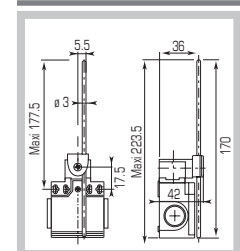
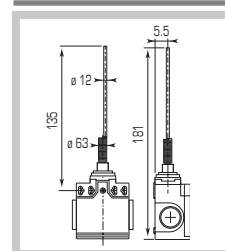
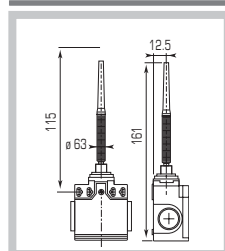
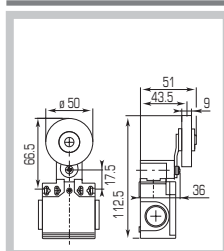
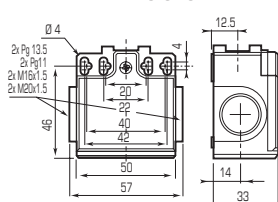

# Limit Switches

## FT1R Series with reset

IP65 □ thermoplastic type



TECHNO-CONTROL EQUIPMENT

1 cable entry  
M16x1.5



FT1R31



FT1R34



FT1R32



FT1R33

TYPE OF OPERATOR	SHORT STEEL END PLUNGER	PA ROLLER PLUNGER	PA ROLLER LEVER PLUNGER HORIZONTAL ACTUATION	PA ROLLER LEVER PLUNGER VERTICAL ACTUATION
Standard - Positive opening NC contacts (→)	- (→)	- (→)	- (→)	- (→)
Minimum tripping force N	15	12	7	7
Minimum positive opening force N	30	30	24	24
<b>Z11</b> Snap action 1NC-1NO	FT1R31Z11 0 13 25 41 56 mm	FT1R34Z11 0 25 47 76 96 mm	FT1R32Z11 0 49 90 145 210 mm	FT1R33Z11 0 49 90 145 210 mm
<b>X11</b> Slow break 1NC-1NO	FT1R31X11 0 16 32 56 mm 2.5	FT1R34X11 0 32 60 96 mm 46	FT1R32X11 0 60 105 210 mm 86	FT1R33X11 0 60 105 210 mm 86
<b>Y11</b> Slow break 1NC-1NO overlapping	FT1R31Y11 0 29 45 56 mm 15	FT1R34Y11 0 53 82 96 mm 30	FT1R32Y11 0 102 146 210 mm 54	FT1R33Y11 0 102 146 210 mm 54
<b>Z02</b> Snap action 2NC	FT1R31Z02 0 13 24 40 56 mm	FT1R34Z02 0 25 45 74 96 mm	FT1R32Z02 0 51 86 131 210 mm	FT1R33Z02 0 51 86 131 210 mm
<b>W02</b> Slow break 2NC	FT1R31W02 0 15 31 56 mm	FT1R34W02 0 30 59 96 mm	FT1R32W02 0 57 102 210 mm	FT1R33W02 0 57 102 210 mm

WEIGHT gr. - MIN. PACK QTY.

75 gr. 1 pcs.

78 gr. 1 pcs.

80 gr. 1 pcs.

80 gr. 1 pcs.

### DIMENSIONS

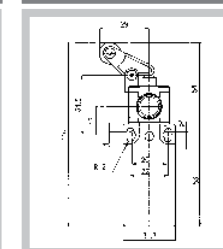
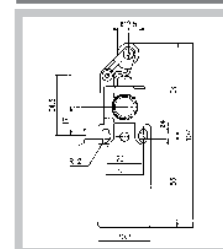
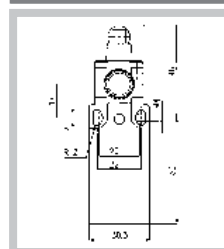
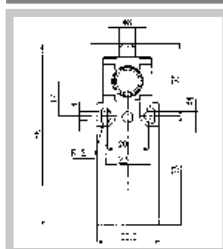
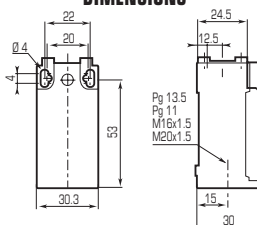



# Limit Switches

## FT1R Series with reset

IP65 □ thermoplastic type

1 cable entry  
M16x1.5



FT1R38













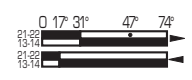
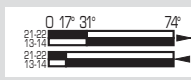
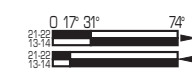

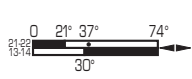
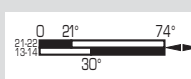
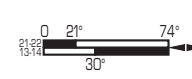
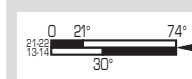
FT1R41

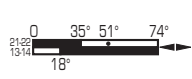
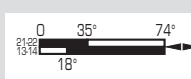
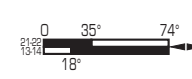
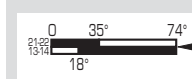

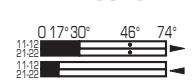
FT1R39

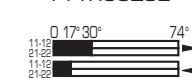
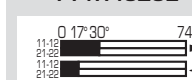

FT1R40

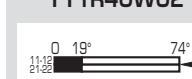
TYPE OF OPERATOR	18 Ø PA ROLLER LEVER	50 Ø RUBBER ROLLER LEVER	VARIABLE LENGTH 18 Ø PA ROLLER LEVER	VARIABLE LENGTH 50 Ø RUBBER ROLLER LEVER
Standard - Positive opening NC contacts (→)	- (→)	-	-	-
Minimum tripping force	0.10	0.10	0.10	0.10
Minimum positive opening force	0.32	-	-	-
<b>Snap action</b>	<b>FT1R38Z11</b>	<b>FT1R41Z11</b>	<b>FT1R39Z11</b>	<b>FT1R40Z11</b>
Z11 1NC-1NO  Zb				
<b>Slow break</b>	<b>FT1R38X11</b>	<b>FT1R41X11</b>	<b>FT1R39X11</b>	<b>FT1R40X11</b>
X11 1NC-1NO  Zb				
<b>Slow break overlapping</b>	<b>FT1R38Y11</b>	<b>FT1R41Y11</b>	<b>FT1R39Y11</b>	<b>FT1R40Y11</b>
Y11 1NC-1NO overlapping  Zb				
<b>Snap action</b>	<b>FT1R38Z02</b>	<b>FT1R41Z02</b>	<b>FT1R39Z02</b>	<b>FT1R40Z02</b>
Z02 2NC  Zb				
<b>Slow break</b>	<b>FT1R38W02</b>	<b>FT1R41W02</b>	<b>FT1R39W02</b>	<b>FT1R40W02</b>
W02 2NC  Zb				

WEIGHT gr. - MIN. PACK QTY.

95 gr. 1 pcs.

110 gr. 1 pcs.

120 gr. 1 pcs.

145 gr. 1 pcs.

### DIMENSIONS

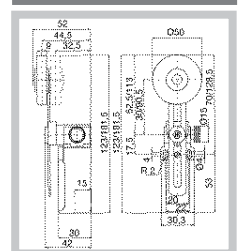
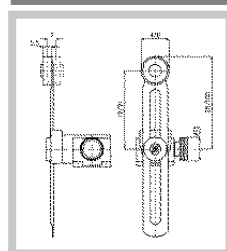
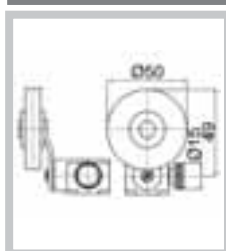
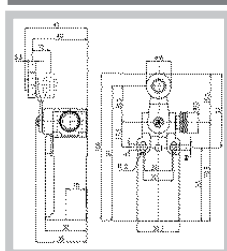
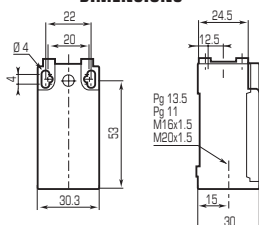

# Safety Limit Switches

## Safety Series - Limit Switches

IP65 □ thermoplastic type



TECHNO-CONTROL EQUIPMENT

1 cable entry  
M16x1.5



ST1K1







ST1K61



ST1K71 Zinc Plated Steel Spindle  
ST1K72 Stainless Steel Spindle

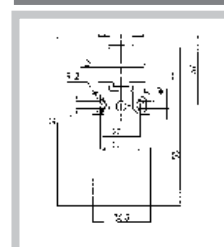
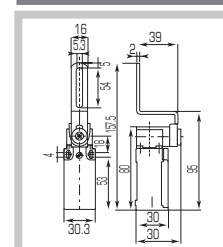
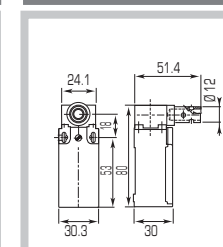
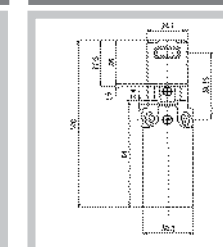

ST1K8

TYPE OF OPERATOR	90° ADJUSTABLE TURRET HEAD WITH ACTUATOR	ADJUSTABLE STEEL ROTARY LEVER	STEEL SPINDLE	360° ADJUSTABLE TURRET HEAD WITH ACTUATOR
Standard - Positive opening NC contacts (→)	- (→)	- (→)	- (→)	-
Minimum tripping force N	-	-	-	-
Minimum positive opening force N	-	-	-	-
<b>Z11</b> <b>1NC-1NO</b> Snap action  Zb	ST1K1*Z11	ST1K61Z11	Zinc Plated ST1K71Z11 Stainless ST1K72Z11	ST1K8*Z11
<b>X11</b> <b>1NC-1NO</b> Slow break  Zb	ST1K1*X11	ST1K61X11	Zinc Plated ST1K71X11 Stainless ST1K72X11	ST1K8*X11
<b>Y11</b> <b>1NC-1NO</b> Slow break overlapping  Zb	ST1K1*Y11	ST1K61Y11	Zinc Plated ST1K71Y11 Stainless ST1K72Y11	ST1K8*Y11
<b>Z02</b> <b>2NC</b> Snap action  Zb	ST1K1*Z02	ST1K61Z02	Zinc Plated ST1K71Z02 Stainless ST1K72Z02	ST1K8*Z02
<b>W02</b> <b>2NC</b> Slow break  Zb	ST1K1*W02	ST1K61W02	Zinc Plated ST1K71W02 Stainless ST1K72W02	ST1K8*W02
<b>WEIGHT gr. - MIN. PACK QTY.</b>	83 gr. 1 pcs.	96 gr. 1 pcs.	80 gr. 1 pcs.	90 gr. 1 pcs.
<b>DIMENSIONS</b>				

\* Include actuator type reference number i.e.: ST1K13Z11

# Safety Limit Switches

## Safety Series - Limit Switches

IP65 □ thermoplastic type

### ACTUATORS

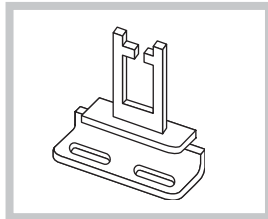

22MM RIGHT-ANGLED ACTUATOR

REFERENCE NO.

3

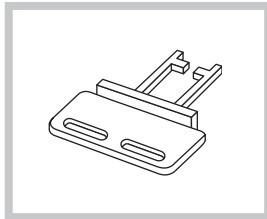

22MM STRAIGHT ACTUATOR

4

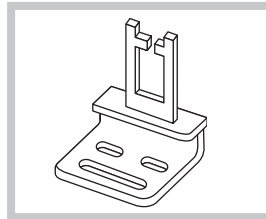

13MM RIGHT-ANGLED ACTUATOR

5

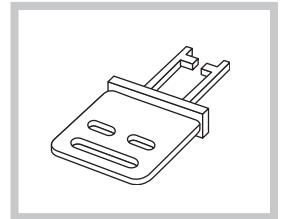

13MM STRAIGHT ACTUATOR

6

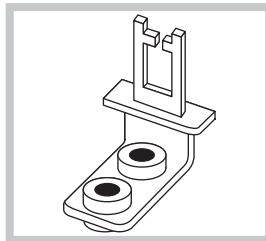

SHOCK ABSORBING RIGHT-ANGLED ACTUATOR

REFERENCE NO.

7

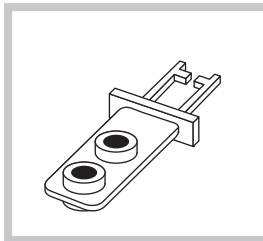

SHOCK ABSORBING STRAIGHT ACTUATOR

8

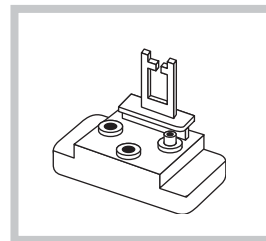

JOINTED KEY ACTUATOR

9

### GENERAL CHARACTERISTICS

Safety limit switches are suitable for stopping dangerous machinery movements on opening of machine guards or protective covers. Available with different type of actuators and controls and with adjustable turret heads which can be rotated through 360° in 90° steps, they can be installed with a wide variety of opening mechanisms.

■ Comply with		IEC/EN60947-5-1, UL508		
■ Rated insulation voltage $U_i$	V	690		
■ Rated impulse withstand voltage $U_{imp}$	kV	6		
■ Operating frequency	Hz	50		
■ Rated thermal current $I_{th}$	A	10		
■ Rated operating current $I_e$ :				
	V	24	230	380
AC15: alternate current	A	10	3.1	1,9
	V	24	250	-
DC13: direct current	A	2.8	0.27	-
■ Conditional short circuit withstand		10A gG fuse rating		
■ Electrical shocks withstand IEC 536		class II		
■ Protection rating IEC/EN 60529		IP65		
■ Operating temperature	°C	-25 +70		
■ Category of use UL 508		A600 - Q600		
■ Certifications		UL		

# Limit Switches

## FA - FT - FT1R Series

Installation and use



TECHNO-CONTROL EQUIPMENT

### REVERSE MOUNTING OF THE OPERATING LEVER

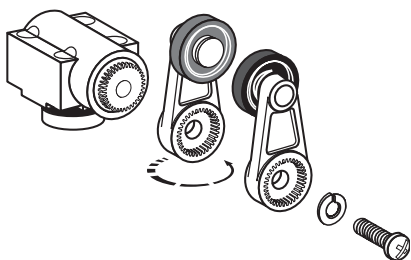

FA - FT - FT1R Series

### REST POSITION SETTING THROUGH 10° STEPS

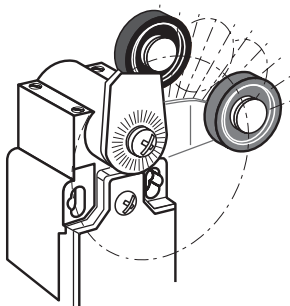

FA - FT - FT1R Series

### STEEL PLUNGER

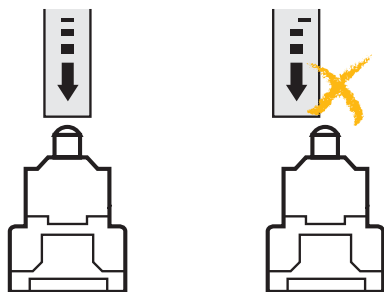

Right

Wrong

### PLUNGER OR ROLLER LEVER

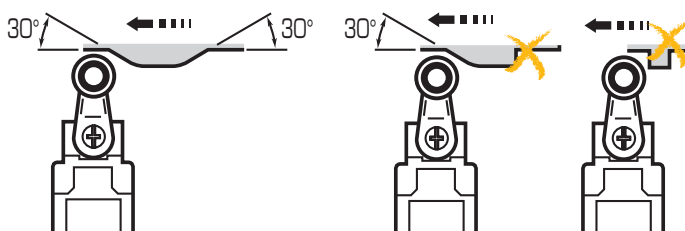

Right

Wrong

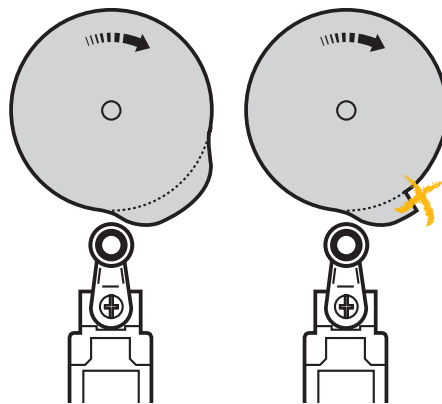

Right

Wrong

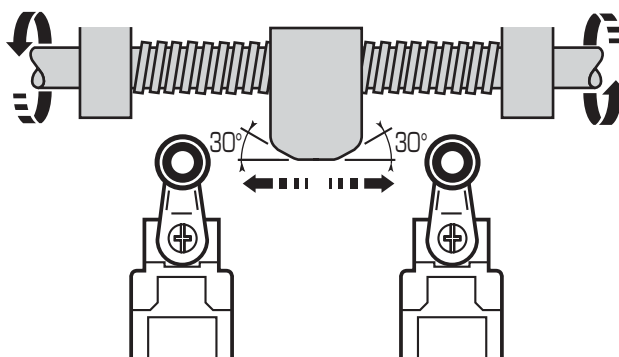

In case of a relatively slow movement of the actuator, snap action contact are recommended

# Limit Switches

## FA - FT - FT1R Series

Technical data

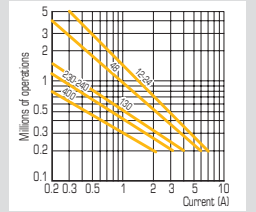
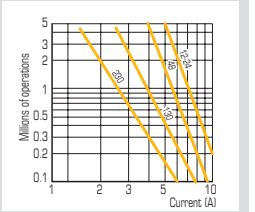
GENERAL CHARACTERISTICS																	
Comply with		IEC947-5-1, EN60947-5-1, UL508, CSA 22.2 n° 14															
Certifications		cUL															
Ambient temperature	°C	Operating -25 +70															
	°C	Storage -30 +80															
Climate protection	IEC68 part 2-3	Hot damp															
	IEC68 part 2-11	Saline fog															
Installation positions		All positions															
Impact resistance	IEC68 part 2-27	50g* (1/2 sinusoidal shock for 11 msec) without replacing contacts															
Vibration resistance	IEC68 part 2-6	25g (10...500 Hz) without replacing contacts >100 msec															
Electrical shocks withstand	IEC536	Class II for FT series - Class I for FA series															
Protection rating	EN60529	IP65 FT series - IP66 - FA series															
Accuracy (measured after 1 million operations)		0.05 FA series - 0.1 FT series (on the making point)															
0.05 Minimum tripping force	m/s	Slow break 0.06 - snap action 0.001															
ELECTRICAL CHARACTERISTICS																	
Rated insulation voltage Ui (IEC/EN60947-1)	V	690 FT series - 400 FA series (3 pollution grade)															
according to UL508 and CSA C22-2 No. 14		600 (designation A600 - Q600)															
Rated impulse withstand voltage Uimp (IEC/EN60947-1)	kV	6															
Rated thermal current Ith (IEC/EN60947-1)	A	10															
Short circuit protection <500 Va.c. - fuses type qG (q17)	A	10															
Rated operating current Ie:																	
AC-15 (IEC/EN60947-5-1)	24 V - 50/60 Hz A	10															
	120 V - 50/60 Hz A	6															
	230 V - 50/60 Hz A	3.1															
	240 V - 50/60 Hz A	3															
	380 V - 50/60 Hz A	1.9															
DC-13 (IEC/EN60947-5-1)	24 V - 50/60 Hz A	2.8															
	120 V - 50/60 Hz A	0.55															
	230 V - 50/60 Hz A	0.27															
Changeover frequency	cycles/hour	3600															
Load factor		0.5															
Contact insulation resistance	mΩ	25															
Termination type		M3.5 screw clamp terminals (+/-) pozidriv 2															
Earth terminal (FA series only)		M3.5 screw clamp terminals (+/-) pozidriv 2															
Terminal capacity solid/flexible conductor	1 or 2 mm <sup>2</sup>	0.75...2.5															
Terminal referencing		according to EN50013															
Mechanical life	millions of operations	15   FA   31; 32; 33															
		10   FT   34; 37; 38...41															
		>5   FT   P31...P33; 35; 36															
Electrical life (according to IEC/EN60947-5-1)		AC-15 and DC-13 categories of use (0.5 load factor according to the diagrams below)															
<b>AC-15 Snap action</b>		<b>AC-15 Slow break</b>															
																	
		<table border="1"> <thead> <tr> <th>DC-13</th> <th>Snap action</th> <th>Slow break</th> </tr> </thead> <tbody> <tr> <td colspan="3">Breaking capacity for a duration of 5 millions cycles</td> </tr> <tr> <td>Voltage 24 V</td> <td>9.5 W</td> <td>12 W</td> </tr> <tr> <td>Voltage 48 V</td> <td>6.8 W</td> <td>9 W</td> </tr> <tr> <td>Voltage 110 V</td> <td>3.6 W</td> <td>6 W</td> </tr> </tbody> </table>	DC-13	Snap action	Slow break	Breaking capacity for a duration of 5 millions cycles			Voltage 24 V	9.5 W	12 W	Voltage 48 V	6.8 W	9 W	Voltage 110 V	3.6 W	6 W
DC-13	Snap action	Slow break															
Breaking capacity for a duration of 5 millions cycles																	
Voltage 24 V	9.5 W	12 W															
Voltage 48 V	6.8 W	9 W															
Voltage 110 V	3.6 W	6 W															

\* 25gr for FA.40 and FT.40

# Limit Switches

## Pre-wired FCT series

IP67 □ thermoplastic type



TECHNO-CONTROL EQUIPMENT

Cable: PVC UL  
5x0.75 mm<sup>2</sup>  
2 m length  
Outlet : horizontal .L.  
vertical .V.



.01.



.02.



.03.



.04.

### TYPE OF OPERATOR

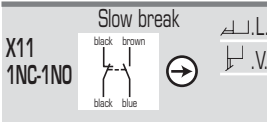

WEIGHT gr. – MIN. PACK QTY.

### DIMENSIONS

### STEEL END PLUNGER

FCT2L01X11  
FCT2V01X11



75 gr. 1 pcs.

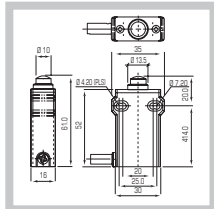

### ROLLER PLUNGER

FCT2L02X11  
FCT2V02X11



78 gr. 1 pcs.

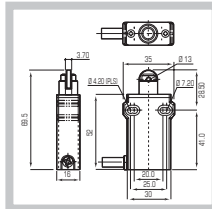

### 90° ROLLER PLUNGER

FCT2L03X11  
FCT2V03X11



80 gr. 1 pcs.

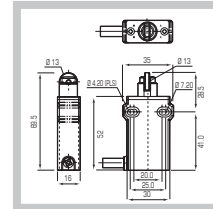

### 14 Ø POM ROLLER LEVER

FCT2L04X11  
FCT2V04X11



80 gr. 1 pcs.

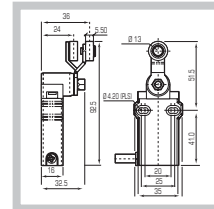

Cable: PVC UL  
5x0.75 mm<sup>2</sup>  
2 m length  
Outlet: horizontal .L.  
vertical .V.



.06.



.07.



.08.

### TYPE OF OPERATOR

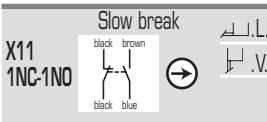

WEIGHT gr. – MIN. PACK QTY.

### DIMENSIONS

### STEEL END PLUNGER WITH THREADED FLANGE

FCT2L06X11  
FCT2V06X11



75 gr. 1 pcs.

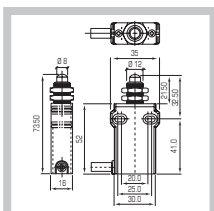

### ROLLER PLUNGER WITH THREADED FLANGE

FCT2L07X11  
FCT2V07X11



78 gr. 1 pcs.

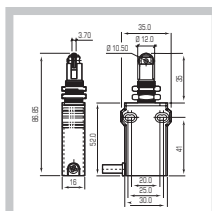

### 90° ROLLER PLUNGER WITH THREADED FLANGE

FCT2L08X11  
FCT2V08X11



80 gr. 1 pcs.

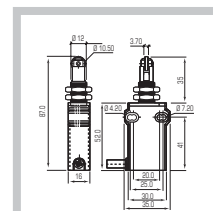

### CHARACTERISTICS

IEC/EN60947-5-1  
Rated insulation voltage  
U<sub>i</sub>/500V  
Rated thermal current I<sub>th</sub> 10A  
Rated operating current I<sub>e</sub>:  
AC15  
U<sub>e</sub> V 120 250 400  
I<sub>e</sub> A 6 4 3  
DC13  
U<sub>e</sub> V 24 125 250  
I<sub>e</sub> A 2,5 0,55 0,27  
UL508  
General use  
Designation A300-G300  
Operating temperature -25 +70 °C  
Self extinguishing body VO

# Limit Switches

## Astra Series

IP54 universal type

2 cable entries  
with cable gland



TYPE OF OPERATOR	STEEL ROLLER PLUNGER	20 Ø PA ROLLER LEVER	35 Ø PA ROLLER LEVER	ROLLER PLUNGER AND LEVER WITH RESET
<b>1NC-1NO</b> Slow break 	<b>30303061</b> 	<b>30303073</b> 	<b>30303025</b> 	<b>30303092</b> lever 
<b>1NC-1NO overlapping</b> Slow break 	<b>30303062</b> 	<b>30303074</b> 	<b>30303026</b> 	<b>30303098</b> with plunger 
<b>WEIGHT gr. – MIN. PACK QTY.</b>	130 gr. 1 pcs.	160 gr. 1 pcs.	200 gr. 1 pcs.	180 gr. 1 pcs.
<b>DIMENSIONS</b>				

### GENERAL CHARACTERISTICS

Comply with	IEC/EN60947-5-1						
Rated insulation voltage $U_i$	500 (pollution class 3)						
Rated impulse withstand voltage $U_{imp}$	4						
Operating frequency	50/60						
Rated thermal current $I_{th}$	10						
Rated operating current $I_e$ :							
AC-15 alterante current	<table border="1"> <tr> <td>110</td> <td>230</td> <td>380</td> </tr> <tr> <td>8</td> <td>8</td> <td>6</td> </tr> </table>	110	230	380	8	8	6
110	230	380					
8	8	6					
Contact type	Slow break double gap contacts						
Protection rating	IP54						
Ambient temperature	Operating -25 +55 Storage -30 +70						
Termination type	Screw clamp terminals						
Materials	Housing in reinforced PA – PC lid Nickel brass plunger – Reinforced PC lever						

# Micro Switches

## MFI Series

Table of contents



TECHNO-CONTROL EQUIPMENT



Standard micro switches with self cleaning contacts  
Supplied with operator.

### TABLE OF CONTENTS

■ MFI Series

pag.96



# Micro Switches

## MFI Series

DIN 41635A - 6.3x0.8 connectors



- Changeover contacts
- High reliability snap action contacts
- Silver alloy self cleaning contacts
- Positive opening NC contact
- 7 versions available
- Certifications:

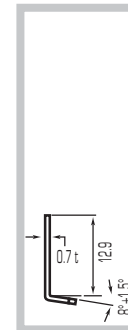
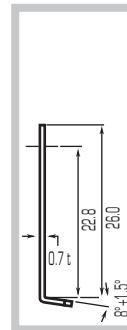
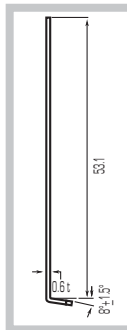
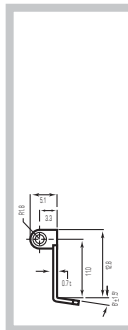
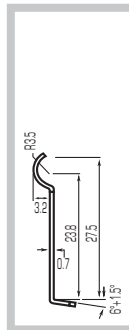
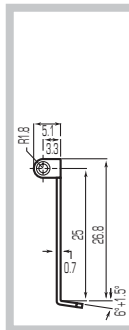
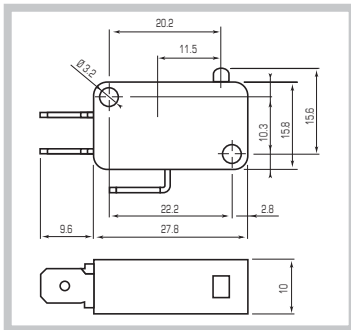

		PIN PLUNGER	LONG ROLLER LEVER	SIMULATED ROLLER LEVER	ROLLER LEVER	LONG LEVER	LEVER	SHORT LEVER
1NC-1NO Snap action		MFI	MFI.1	MFI.2	MFI.3	MFI.4	MFI.5	MFI.6
Operating force	N	4.5	3.2	3.2	4.5	1.3	3.2	4.5
Resetting force	N	1.9	1.2	1.2	1.9	0.15	1.2	1.9
Max pre travel PT	mm	1.4	3.3	3.3	1.4	7.6	3.3	1.4
Min over travel	mm	0.8	0.8	0.8	0.6	2.2	0.8	0.6
Tripping position OP	mm	14.4±0.4	21.8±1.2	18.9±1.2	20±0.6	15.2±1.2	15.2±1.2	15.1±0.5

### GENERAL CHARACTERISTICS

■ Comply with		IEC/EN61058, UL1054
■ Rated insulation voltage $U_i$	V	250V
■ Rated impulse withstand voltage $U_{imp}$	V	1500
■ Rated thermal current $I_{th}$	A	8
■ Rated operating current $I_e$ :	ac	8A - 250V resistive load, 3A - 250V inductive load
■ Ambient temperature	°C	-25 +85
■ Electric shock protection		Class II
■ Pollution class		2
■ Life	cycles	Mechanical $10^6$ , electrical $5 \times 10^5$
■ Termination type		6.3x0.8 faston terminal

# Foot switches

## IP Series

Table of contents



TECHNO-CONTROL EQUIPMENT



Single or double foot switches with the EN418 emergency stop option.  
Available with electric or pneumatic controls.

### TABLE OF CONTENTS

■ Single foot switches	pag. 98	■ Double foot switches - Technical data	pag. 99
------------------------	---------	---	---------

# Foot switches





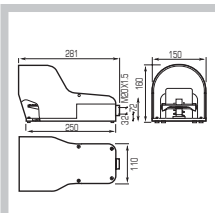

## IP Series

IP54 □ thermoplastic type – Single

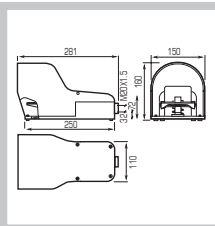
### SAFETY FOOT SWITCHES

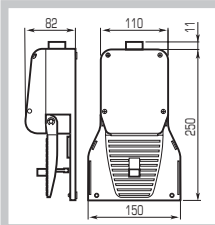
	DESCRIPTION	CONTACTS	REFERENCE NO.	WEIGHT gr.	MIN. PACK QTY.	DIMENSIONS
	With trigger mechanism requiring positive action to allow pedal operation	Slow break <b>1NO</b>	IP7007	1.400	1	
		<b>2NO</b>	IP7008			

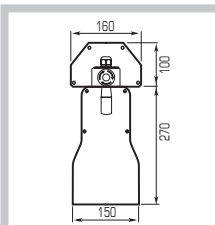
### FOOT SWITCHES

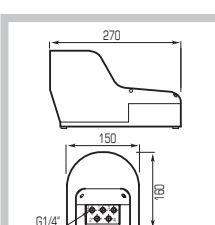
	DESCRIPTION	CONTACTS	REFERENCE NO.	WEIGHT gr.	MIN. PACK QTY.	DIMENSIONS
	With pedal latching device and without trigger mechanism	Slow break <b>1NO</b>	IP 7011	1.400	1	
	Without rest position trigger mechanism	Slow break <b>1NC+1NO</b>	IP7006I	1.300	1	
	With trigger mechanism and EN418 emergency stop	Slow break <b>1NO</b>	IP7007EM	3.900	1	
	Pneumatic with trigger mechanism	With 1/4" 5 ways valve	IP7023	1.600	1	
	Pneumatic with pedal latching device and without trigger mechanism		IP7024		1	

# Foot switches

## IP Series

IP54 □ thermoplastic type – Double



TECHNO-CONTROL EQUIPMENT

### DOUBLE

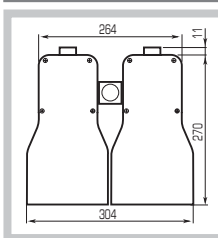
DESCRIPTION	CONTACTS	REFERENCE NO.	WEIGHT gr.	MIN. PACK QTY.	DIMENSIONS
 <p>With trigger mechanism requiring positive action to allow pedal operation</p>	Slow break		3.100	1	
	1NO	IP7018			
	2NO	IP7019			

### DOUBLE WITH EN418 EMERGENCY STOP

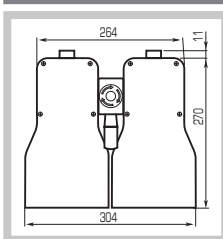
DESCRIPTION	CONTACTS	REFERENCE NO.	WEIGHT gr.	MIN. PACK QTY.	DIMENSIONS
 <p>With trigger mechanism requiring positive action to allow pedal operation</p>	Slow break		5.300	1	
	1NO	IP7018EM			
	2NO	IP7019EM			

### GENERAL CHARACTERISTICS

Comply with		IEC/EN60947-5-1
Rated insulation voltage $U_i$	V	690 (pollution class 3)
Rated impulse withstand voltage $U_{imp}$	kV	4
Operating frequency	Hz	50/60
Rated thermal current $I_{th}$	A	10
Rated operating current $I_e$ :		
AC-15 alterante current	V	24   60   110   230   400
	A	16   12   8   6   4,5
DC-13 continuous current	V	24   48   60   110   230
	A	2   1,2   0,85   0,4   0,25
Conditional short circuit withstand		1000A - 10A-500V class gG fuses
Contact impedance	mΩ	≤25
Contact type		Slow break double gap contacts
Positive opening		NC contact with positive opening (→)
Electric shock protection		Class II
Protection rating		IP54
Ambient temperature	°C	Operating -25 +70
	°C	Storage -30 +70
Termination type		Screw clamp terminals
Cable entry		No. 1 M20x1.5



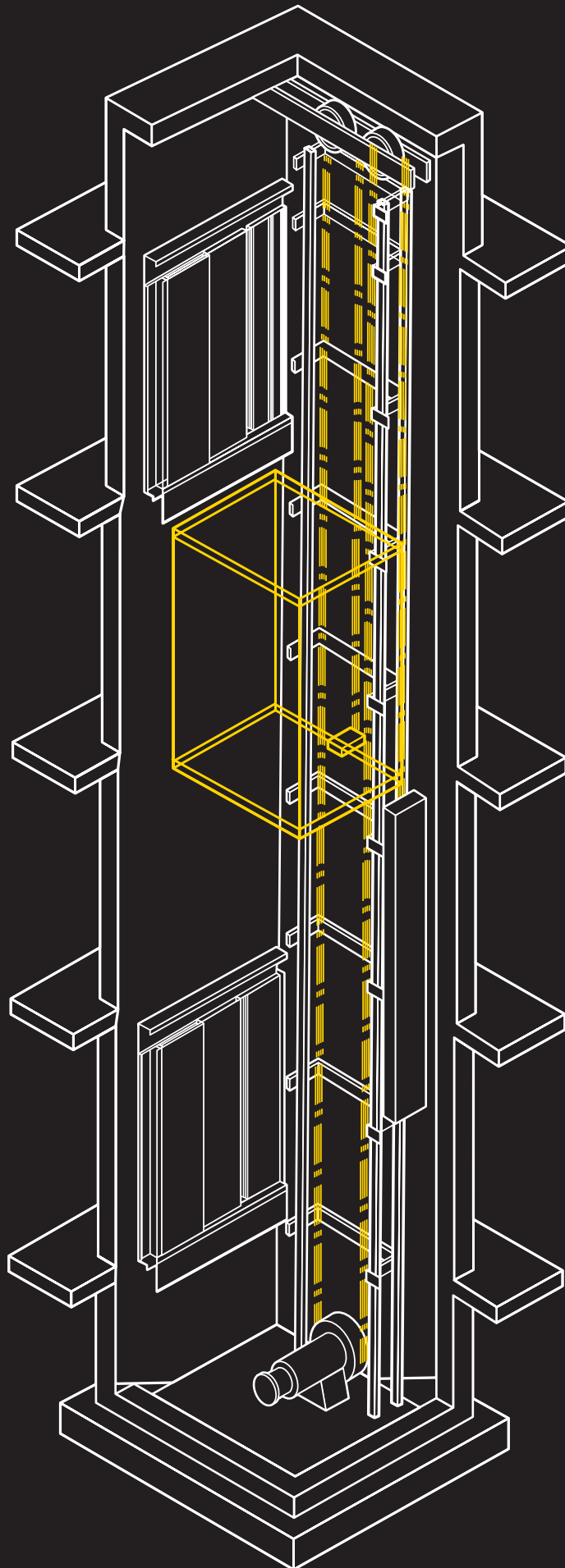
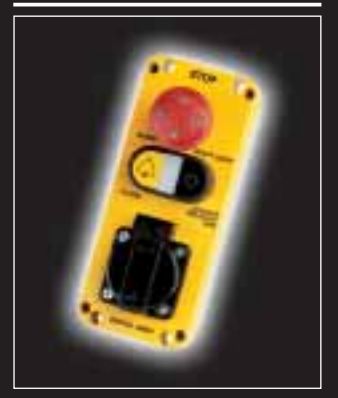



# Lift

Pit bottom push button stations, recall drive control units and EN81 inspection boxes  
Table of contents



TECHNO-CONTROL EQUIPMENT



Pit bottom switches with knob or interlocked lever; recall drive units with socket outlets, inspection boxes from 4 up to 8 functions.

Fully compliant with EN81..EN60068-2-6 - Resistance to vibrations - EN60068-2-27 Resistance to shocks. All components of the GM series are designed to the relevant standards, hence ensuring the correct creepage and clearance distances after possible vibrations and shocks.

## TABLE OF CONTENTS

■ Pit bottom and recall drive control unit switches - Inspection boxes – Technical data	pag. 104	■ Recall drive push button stations	pag. 106
■ Pit bottom and recall drive control unit switches	pag. 105	■ Inspection boxes	pag. 107
		■ Accessories	pag. 110



# Lift

## Pit bottom push button stations, recall drive control units and EN81 Inspection boxes □ - Characteristics

### ELECTRICAL CHARACTERISTICS

Giovenzana International B.V. is the market leader in the elevator market for electrical control accessories dedicated to maintenance. The different installations follow the guidelines set by the CEE95/16 directive and are designed for maximum safety. All articles are designed in compliance with the relevant product standard (IEC/EN 60947-3, IEC/EN 60947-5-1) and destination of use (EN 418 and IEC/EN 60204-1). The Lift series includes three product families that are commonly used in this field: pit bottom, recall drive push button stations, inspection boxes. On top of the standard range, made to order solutions are available complete with connectors.

- Comply with EN 418 and IEC/EN 60204-1
- Enclosures made of self extinguishing thermoplastic material. Double insulation
- Protection rating: IEC/EN60529 IP65 (IP54 with socket outlet)
- Ambient temperature: Operating -25 °C +70 °C - Storage -30 °C +70 °C
- **Spring loaded terminal contact blocks**
- Vibration resistance IEC/EN60068-2-6 25g (10...500 Hz)

### ELECTRICAL CHARACTERISTICS





		CONTACT BLOCKS		SWITCHES					
		IEC/EN60947-5-1 UL508		IEC/EN60947-3 UL508					
Comply with		IEC/EN60947-5-1 UL508		IEC/EN60947-3 UL508					
Certifications		IMQ, CCC, GOST, UL							
Rated insulation voltage $U_i$	V	690		690					
Rated impulse withstand voltage $U_{imp}$	kV	4		4					
Rated thermal current $I_{th}$	A	16		16					
Frequency	Hz	50/60		50/60					
Rated operating current $I_e$ :									
AC-15 alterante current	V	24	60	110	230	400	500	690	-
	A	16	12	5	5	4	4	4	-
AC-21A alterante current	A	-		16					
AC-22A alterante current	A	-		16					
Conditional short circuit withstand	A	1000		5000					
Class gG fuses	A	10A - 500V		20A - 690V					
Contact type		Slow break double gap contacts							
Positive operation		NC contact with positive opening $\oplus$		Suitable for sectioning					
Terminal type		Spring loaded		M3.5					
Terminal capacity:	Solid and flexible cable n. 1 min/max mm <sup>2</sup>	0,5/2,5		0.75/4					
	n. 2 min/max mm <sup>2</sup>	0,5/2,5		0.75/2.5					
	AWG	20-12		16-12					

# Lift

## Pit bottom and recall drive control unit switches IP54

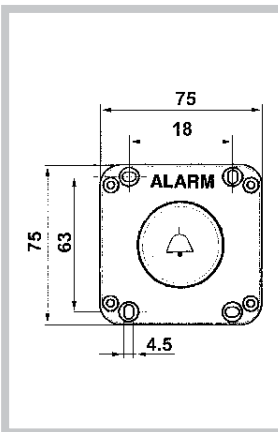

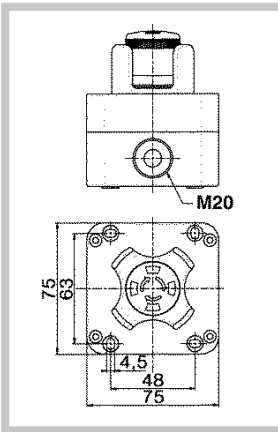
TECHNO-CONTROL EQUIPMENT

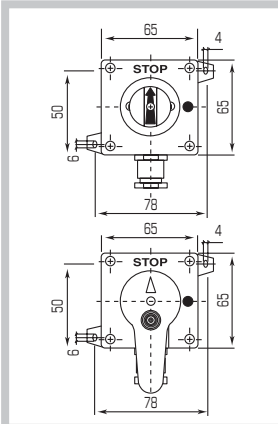
	DESCRIPTION	REFERENCE NO.	WEIGHT gr.	DIMENSIONS
	<p><b>Alarm push button station CE 95/16</b></p> <hr/> <p>Mushroom operator <math>\varnothing</math> 40</p>	<p><b>GM01FN3</b></p>	<p>150</p>	
	<p><b>Emergency stop push button station EN418</b> </p> <hr/> <p>Guarded mushroom operator <math>\varnothing</math> 40 push-pull with vision</p>	<p><b>GM01P4SP</b></p>	<p>150</p>	
	<p><b>Pit bottom switch</b></p> <hr/> <p>1P knob operated switch</p> <hr/> <p>1P lever operated switch with interlock in the Stop position</p> <hr/> <p>2P knob operated switch</p> <hr/> <p>Ui 440 - lthe 16A AC - 21A le 16A - 400V</p>	<p><b>GM353</b></p> <hr/> <p><b>GM354</b></p> <hr/> <p><b>GM355</b></p>	<p>90</p> <hr/> <p>110</p> <hr/> <p>95</p>	

# Lift

## Recall drive push button stations

IP54 □



### DESCRIPTION

**Emergency stop ø 40  
push-pull EN418** (Mushroom icon)  
with:

No. 1 10A Schuko socket outlet

No. 1 CENELEC socket outlet

No. 1 American socket outlet

**Contacts:** Emergency 1NC

### REFERENCE NO.

Mushroom with vision	Ergonomic mushroom
GM400	GM400.E
GM407	GM407.E
GM408	GM408.E

### WEIGHT gr.

265

265

265

### DIMENSIONS

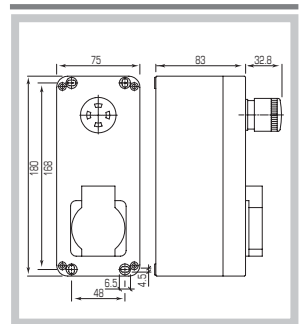

**3P 16A-690V  
0-1 switch:**

No. 1 10A Schuko socket outlet

No. 1 CENELEC socket outlet

**GM410**

220

**GM411**

220

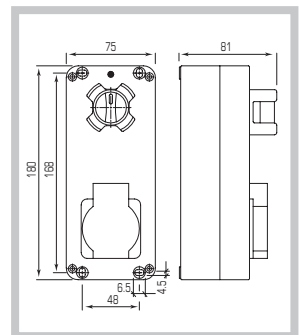

**Emergency stop ø 40  
push-pull EN418** (Mushroom icon)  
with:

No. 1 alarm push button

No. 1 10A Schuko socket outlet

No. 1 knob selector 0/1 90° op. angle

No. 1 10A Schuko socket outlet

**Contacts:**

Emergency 1NC

Push button 1NO

Selector 1NO

**GM401**

420

**GM403**

420

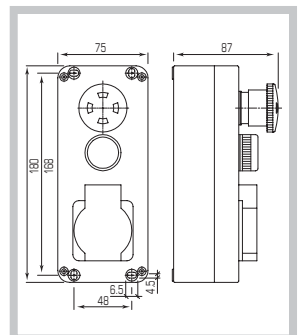

**Emergency stop ø 40  
push-pull EN418** (Mushroom icon)  
+ No. 1 multi-function  
alarm-light push button  
with:

No. 1 10A Schuko socket outlet

No. 1 CENELEC socket outlet

**Contacts:**

Emergency 1NC

Push button 1NO

Selector 1NO

**GM491**

450

**GM492**

450

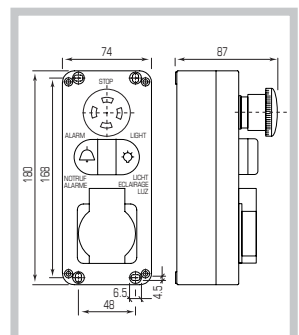







# Lift

## Inspection push button stations

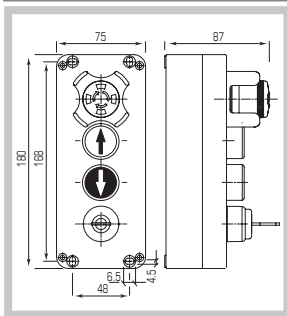
IP54 □

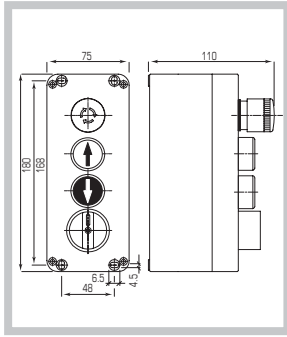

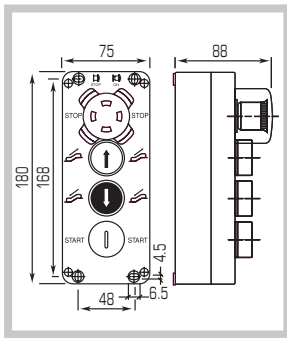

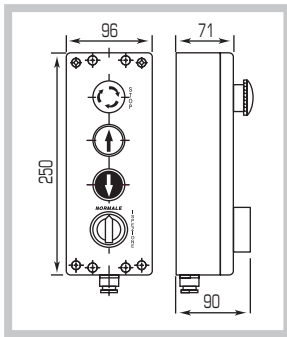





TECHNO-CONTROL EQUIPMENT

	DESCRIPTION	REFERENCE NO.	WEIGHT gr.	DIMENSIONS
	<p>Emergency stop ø 30 twist to release EN418 (⊙)</p> <p>with:</p> <p>No. 1 UP push button</p> <p>No. 1 DOWN push button</p> <p>No. 1 key selector</p> <p><b>Contacts:</b> Emergency 1NC Push buttons UP 2NO - DOWN 2NO Selector 1NO</p>	<b>GM420</b>	690	
	<p>Emergency stop ø 30 twist to release EN418 (⊙)</p> <p>with:</p> <p>No. 1 UP push button</p> <p>No. 1 DOWN push button</p> <p>No. 1 changeover switch 1-0-2</p> <p><b>Contacts:</b> Emergency 1NC Push buttons UP 2NO - DOWN 2NO Changeover switch 2NO+2NC</p>	<b>GM488</b>	680	
	<p>Emergency stop ø 40 twist to release EN418 (⊙)</p> <p>with:</p> <p>No. 1 UP push button</p> <p>No. 1 DOWN push button</p> <p>No. 1 START push button</p> <p><b>Contacts:</b> Emergency 1NC Push button UP 1NC+1NO Push button DOWN 1NC+1NO Push button START 1NO</p>	<b>GM482</b>	690	
	<p>Emergency stop ø 40 twist to release EN418 (⊙)</p> <p>+ No. 1 UP push button + No. 1 DOWN push button with:</p> <p>No. 1 changeover switch 1-0-2</p> <p>No. 1 changeover switch 1-2</p> <p><b>Contacts:</b> Emergency 1NC Push button UP 2NO Push button DOWN 2NO Changeover switch 2NO+2NC</p>	<b>GM442N</b> <b>GM444N</b>	635 635	

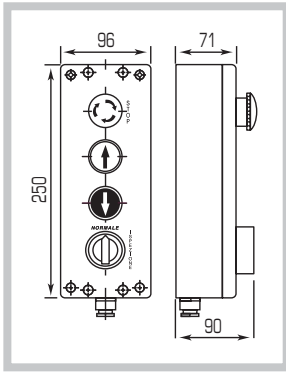
# Lift

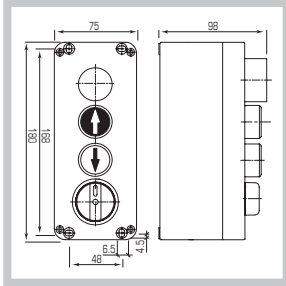
## Inspection push button stations

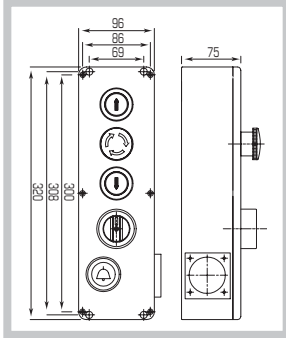
IP54 □

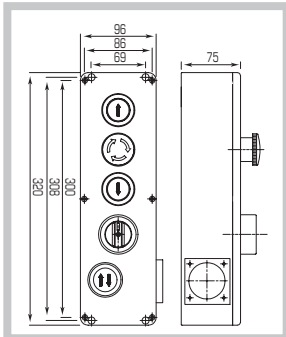
	DESCRIPTION	REFERENCE NO.	WEIGHT gr.	DIMENSIONS
	<p>Emergency stop <math>\varnothing</math> 40 twist to release EN418 </p> <p>+ No. 1 UP push button</p> <p>+ No. 1 DOWN push button with:</p> <p>No. 1 changeover switch 1-2</p> <p>No. 1 10A Schuko socket outlet (side mounted)</p> <p>No. 1 changeover switch 1-0-2</p> <p>No. 1 10A Schuko socket outlet (side mounted)</p> <p><b>Contacts:</b> Emergency 1NC Push buttons UP 2NO - DOWN 2NO Changeover switch 2NO+2NC</p>	<p><b>GM441N</b></p> <p><b>GM445N</b></p>	<p>680</p> <p>680</p>	
	<p><b>LED pilot light with:</b></p> <p>No. 1 UP push button</p> <p>No. 1 DOWN push button</p> <p>No. 1 changeover switch 1-2</p> <p><b>Contacts:</b> Push buttons UP 1NO - DOWN 1NO Changeover switch 2NO+2NC</p>	<b>GM483</b>	600	
	<p>Emergency stop <math>\varnothing</math> 40 twist to release EN418 </p> <p>+ No. 1 UP push button</p> <p>+ No. 1 DOWN push button</p> <p>+ No. 1 alarm push button + No. 1 10A Schuko socket outlet (side mounted) with:</p> <p>No. 1 changeover switch 1-2</p> <p>No. 1 changeover switch 1-0-2</p> <p><b>Contacts:</b> Emergency 2NC Push buttons UP 2NO - DOWN 2NO Alarm push button 1NO+1NC, Changeover switch 3NO+3NC</p>	<p><b>GM660</b></p> <p><b>GM670</b></p>	<p>800</p> <p>800</p>	
	<p>Emergency stop <math>\varnothing</math> 40 twist to release EN418 </p> <p>+ No. 1 UP push button</p> <p>+ No. 1 DOWN push button</p> <p>+ No. 1 common push button + No. 1 10A Schuko socket outlet (side mounted) with:</p> <p>No. 1 changeover switch 1-2</p> <p>No. 1 changeover switch 1-0-2</p> <p><b>Contacts:</b> Emergency 2NC Push buttons UP 2NO - DOWN 2NO Common push button 2NO, Changeover switch 3NO+3NC</p>	<p><b>GM663</b></p> <p><b>GM677</b></p>	<p>800</p> <p>800</p>	



# Lift

## Inspection push button stations

IP54 □

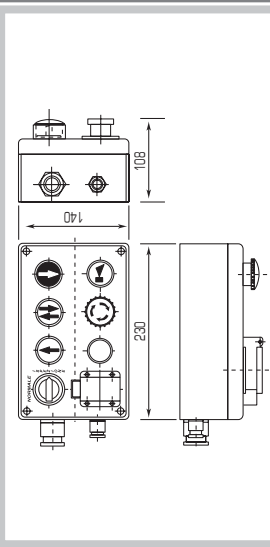

TECHNO-CONTROL EQUIPMENT

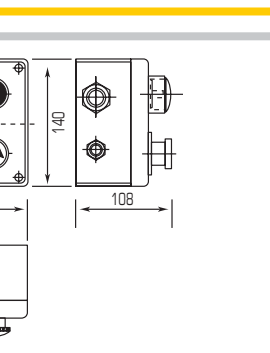
	DESCRIPTION	REFERENCE NO.	WEIGHT gr.	DIMENSIONS
	<p><b>Emergency stop</b>  <b>ø 40 twist to release EN418</b> (→)</p> <p><b>with:</b></p> <ul style="list-style-type: none"> <li>No. 1 UP push button</li> <li>No. 1 DOWN push button</li> <li>No. 1 alarm push button</li> <li>No. 1 common push button</li> <li>No. 1 changeover switch 1-2</li> <li>No. 1 10A Schuko socket outlet</li> </ul> <p><b>Contacts:</b>                      Emergency 2NC                      Push buttons UP - DOWN 2NO+1NC                      Alarm push button 1NO                      Common push button 2NO                      Changeover switch 3NO+3NC</p>	<p><b>GM412</b></p>	<p><b>950</b></p>	
	<p><b>Emergency stop</b> (→)</p> <p><b>with:</b></p> <ul style="list-style-type: none"> <li>No. 1 UP push button</li> <li>No. 1 DOWN push button</li> <li>No. 1 alarm push button</li> <li>No. 1 common push button</li> <li>No. 1 LED pilot light</li> <li>No. 1 changeover switch 1-2</li> <li>No. 1 10A Schuko socket outlet</li> </ul> <p><b>Contacts:</b>                      Emergency 1NC                      Push buttons UP - DOWN 2NO+1NC                      Alarm push button 1NO - Common push button 2NO                      Changeover switch 3NO+3NC</p>	<p><b>GM822</b></p>	<p><b>965</b></p>	

# Lift

Pit bottom push button stations, recall drive control units and inspection boxes  
Accessories

## AMERICAN SOCKET OUTLET



20401369

## EUROPEAN SOCKET OUTLET



20401371

## FRENCH SOCKET OUTLET



20401372

## BRITISH STANDARD SOCKET OUTLET



20401398

## SWISS SOCKET OUTLET



20401399

## CONTACT BLOCKS



Spring loaded terminals

1NC	PCW01
1NO	PCW10

## BAGS LAMP HOLDER



Direct power supply with spring loaded terminals

PCWAD

## EMERGENCY STOP GUARD

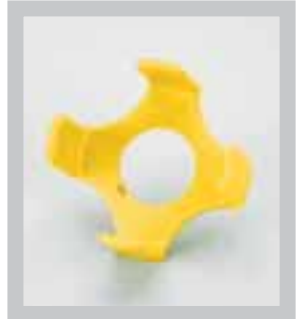

11706006



## SPECIALS

It is possible to supply custom made assemblies according to the specifications required by the customer:

- Custom made push buttons and controls
- Pre-cabled
- With or without connectors
- With dedicated brackets

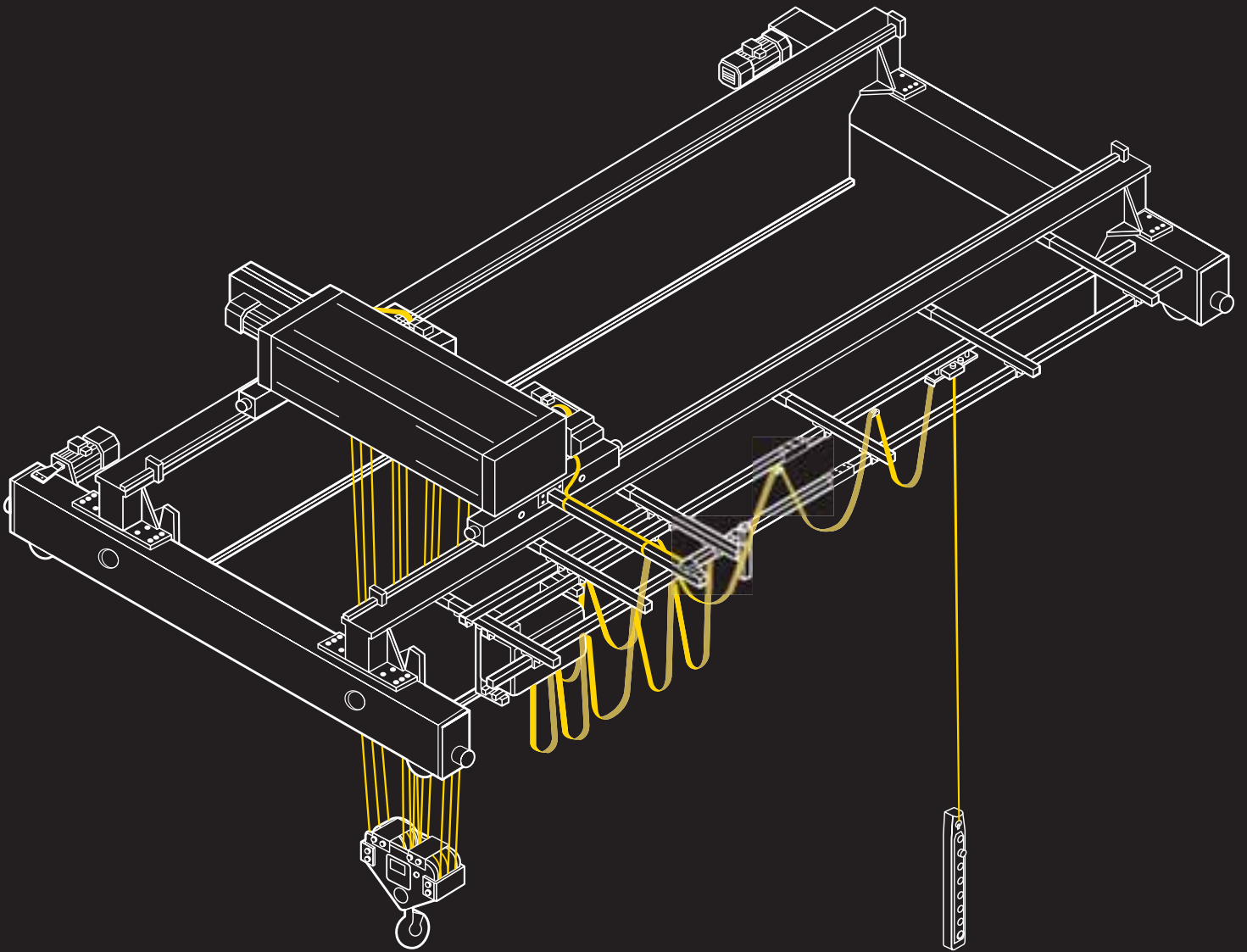





# Pendant stations

P02 - PTRM - P03 - DC16 - PL - DC30 - TLP Series

Table of contents



TECHNO-CONTROL EQUIPMENT



Push button stations for small hoist applications, for control circuits in both single or double row versions, for control and direct switching power circuits, for tail lifts control.

## TABLE OF CONTENTS

■ General characteristics	pag. 114	■ Accessories	pag. 121
■ P02-PTRM series pendant stations for small hoist applications	pag. 115	■ PL - PLB series pendant stations for control circuits – Composition	pag. 122
■ P03 series pendant stations for small hoist applications	pag. 116	■ PL - PLB series pendant stations for control circuits – Engravings	pag. 123
■ DC16 series pendant stations for small hoist applications	pag. 117	■ PL - PLB series pendant stations for control circuits – Assembly	pag. 124
■ Single row PL series pendant stations for control circuits	pag. 118	■ DC30 series pendant stations for direct switching power circuits	pag. 126
■ Double row PL series pendant stations for control circuits	pag. 119	■ DC30 series accessories	pag. 128
■ PL series pendant station enclosures for control circuits	pag. 120	■ TLP series push button stations for tail lifts	pag. 129
		■ Characteristics	pag. 131

# Pendant stations

## P02 - PTRM - P03 - DC16 - PL - DC30 - TLP Series

### General characteristics

According to the CE89/392 directives appendix IIB concerning machinery

#### GIOVENZANA

declares that P02 - P03 - PL - PLB pendant stations comply with the following standards:

#### Harmonised standards

EN292 part 1 and 2 (machine safety)  
UNI EN ISO 9001  
EN60529 (IP rating)

#### Standards and technical specifications

IEC 947-5-1 (low voltage equipment)  
FEM 9.941 (operators' designation)

#### As stated in appendix V of the CE directives with regards to machinery

The technical documentation is held by the manufacturer.

The company Giovenzana, leader in lifting equipment control accessories, has designed the P02 - P03 - PL - PLB series pendant stations according to the relevant International standards

These new product series are the end result of a close investigation with regards to the operator's needs and requirements:

- Adequate cabling space
- Ease of use thanks to a light and user friendly pendant station
- Versatility of assembly allowing quick and easy replacement of the 22 Ø operators and their Pegasus contact blocks
- Each pendant station is provided with a new generation EN418 emergency stop incorporating a snap action actuation that prevents halting the machinery before the mushroom is in the locked position. Contacts are "positive opening" type.
- The following contacts are supplied as standard:  
1NO for the movement (FEM 9.941)  
1NC for emergency (EN418)  
1NO+1NO for double speed  
Optional accessories are always supplied separately and installed by the end user.

#### GENERAL CHARACTERISTICS

- Double insulated enclosures in thermoplastic self-extinguishing material
- IP65 rating according to EN60529
- Operating temperature -25 +70 °C
- Available from 2 up to 14 holes - 22 Ø - on single or double row
- Cable entry: P02 - PTRM - P03 - PL with variable section cable sleeve  
DC16 - DC30 - TLP with cable clamp
- Mechanical life: push buttons and rotary switches
- 1 mil. operations  
Latched emergency stops
- 0,3 mil. operations

#### CONTACT BLOCK CHARACTERISTICS

- VO UL94 self-extinguishing material
- Rated thermal current: 16A
- Rated insulation voltage: 690V
- Insulation category: Group CV VDE 0110
- Contact impedance:  $\leq 25 \text{ M}\Omega$
- Slow break self cleaning double gap contact block - Positive opening NC contact block
- Tripping force: 4N
- Terminal protection rating: IP20 - EN60529
- Max contact No.: 3
- **UL A600 - Q 600 certified**

# Pendant stations

## P02-PTRM Series for small hoist applications

IP65 □



TECHNO-CONTROL EQUIPMENT

### P02

2 directions mechanically interlocked



#### ENGRAVING



#### DESCRIPTION

For single-speed motor control  
No. 2 push buttons with 1 NO contact  
No. 2 push buttons with 2 NO contacts  
No. 2 push buttons with 1NC+1NO contacts

For two-speed motor control  
No. 2 push buttons with NO contacts

For 1kW single-phase motor control  
No. 2 push buttons with 1NC+2NO contacts

#### REFERENCE NO.

P02.1

P02.2

P02.4

P02.D2

P02.CD

#### WEIGHT gr

230

250

250

250

230

#### DIMENSIONS

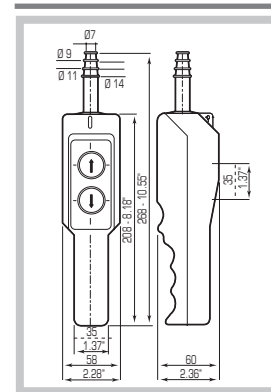

For single-speed motor control

No. 1 Emergency stop  
ø 30 turn to release  
EN418

No. 1 two way and off switch with spring return  
Auxiliary  
16A - 250V ac 1/2 HP

P02.RM

230

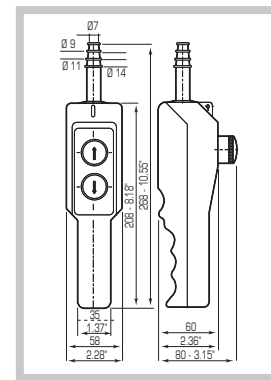

### PTRM



#### ENGRAVING



#### DESCRIPTION

For single-speed motor control  
Provision for capacitor  
45x90 Ø max

No. 1 Emergency stop  
ø 30 turn to release  
EN418

No. 1 two way and off switch with spring return  
Auxiliary  
16A - 250V ac 1/2 HP

#### REFERENCE NO.

PTRM

#### WEIGHT gr

230

#### DIMENSIONS

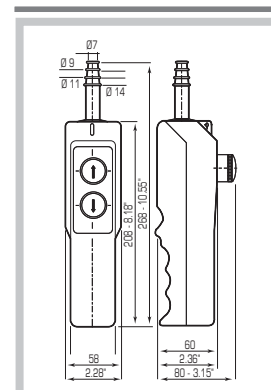















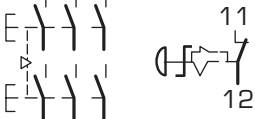
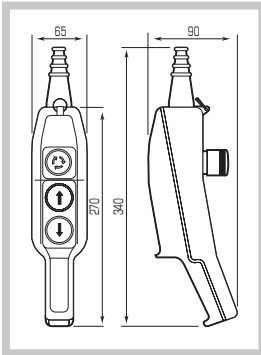

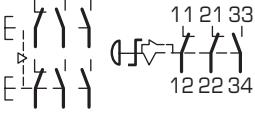

# Pendant stations

## P03 Series for small hoist applications

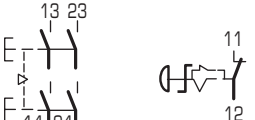
IP65 □

### P03

2 directions mechanically interlocked

	ENGRAVING	DESCRIPTION	REFERENCE NO.	WEIGHT gr	DIMENSIONS	
	  	<p>For single-speed motor control</p> <p>No. 1 Emergency stop ø 30 turn to release EN418 with:</p> <p>No. 2 push buttons with 1 NO contact No. 2 push buttons with 2 NO contacts No. 2 push buttons with 3 NO contacts</p> 	<p><b>P03.1</b></p> <p><b>P03.2</b></p> <p><b>P03.3</b></p>	<p>440</p> <p>450</p> <p>460</p>		
		  	<p>For 1kW single-phase motor control</p> <p>No. 1 Emergency stop ø 30 turn to release EN418 with:</p> <p>No. 2 push buttons with 1NC+2NO contacts</p> 	<p><b>P03CD</b></p>		<p>460</p>
			  	<p>For two-speed motor control</p> <p>No. 1 Emergency stop ø 30 turn to release EN418 with:</p> <p>No. 2 push buttons with 1NC+2NO contacts</p> 		<p><b>P03D2</b></p>
	  		<p>For single-speed motor control</p> <p>No. 1 90° angle latched key switch O-1 with 1 NO contact and:</p> <p>No. 2 push buttons with 1 NO contact</p> 	<p><b>P03CH</b></p>	<p>460</p>	

# Pendant stations

## DC16 Series for small hoist applications

IP65 □



TECHNO-CONTROL EQUIPMENT

### GENERAL CHARACTERISTICS

- Double insulated ABS enclosures
- IP65 protection rating according to IEC/EN 60529
- Ambient temperature: operating  $-25^{\circ}$   $+70^{\circ}$  °C  
storage  $-40^{\circ}$   $+70^{\circ}$  °C
- Double gap slow break contacts
- Cable entry with M25 cable clamp
- Rated insulation voltage:  $U_i$  690V
- Rated thermal current Ith: 16A
- Rated operating power: 400V ac -1kW

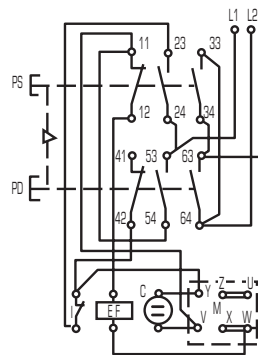

### 1KW DIRECT SWITCHING MOTOR WIRING DIAGRAM

PS UP push button

PD DOWN push button

I Top limit switch

M Motor

C Capacitor

EF Electric break

2 directions mechanically interlocked

#### ENGRAVING

#### DESCRIPTION

#### REFERENCE NO.

#### WEIGHT gr

#### DIMENSIONS



For 1kW single-phase motor control  
No. 1 Emergency stop  
 $\varnothing$  30 turn to release  
EN418 with 2NC+1NO  
contacts and:  
No. 2 push buttons with 1NC+2NO contacts

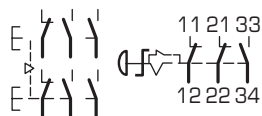

DC16

470



For 1kW single-phase motor control  
No. 1 Emergency stop  
 $\varnothing$  30 turn to release  
EN418 with 2NC  
contacts and:  
No. 2 push buttons with 1NC+2NO contacts

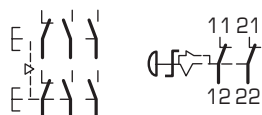

DC161



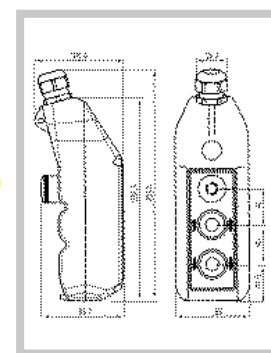

490



# Pendant stations

## PL Series for control circuits

IP65 □ Single row

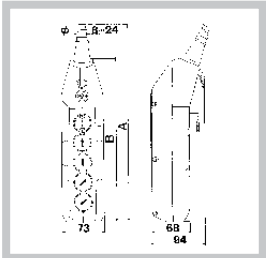
	PUSH BUTTONS	DESCRIPTION	REFERENCE NO.	WEIGHT gr		
	4+1	For single-speed motor control 4 mechanically interlocked between pairs + 1 Emergency stop ø 30 turn to release EN418	PL05	560		
	4+1	For two-speed motor control ▶▶ 4 mechanically interlocked between pairs + 1 Emergency stop ø 30 turn to release EN418		No. of 2-speed movements		
				2	PL05D2	590
			4	PL05D4	620	
	6+1	For single-speed motor control 6 mechanically interlocked + 1 Emergency stop ø 30 turn to release EN418	PL07	740		
	6+1	For two-speed motor control ▶▶ 6 mechanically interlocked between pairs + 1 Emergency stop ø 30 turn to release EN418		No. of 2-speed movements		
				2	PL07D2	770
				4	PL07D4	800
			6	PL07D6	830	
	6+2	For single-speed motor control 6 mechanically interlocked between pairs + 1 Start/Alarm + 1 Emergency stop ø 30 turn to release EN418	PL08	830		
	6+2	For two-speed motor control ▶▶ 6 mechanically interlocked between pairs + 1 Start/Alarm + 1 Emergency stop ø 30 turn to release EN418		No. of 2-speed movements		
				2	PL08D2	860
				4	PL08D4	890
			6	PL08D6	920	
	8+2	For single-speed motor control 8 mechanically interlocked between pairs + 1 Start/Alarm + 1 Emergency stop ø 30 turn to release EN418	PL10	990		
	10+2	For single-speed motor control 10 mechanically interlocked between pairs + 1 Start/Alarm + 1 Emergency stop ø 30 turn to release EN418	PL12	1.140		
	<b>DIMENSIONS</b>					
	PUSH BUTTONS	REFERENCE NO.	Amm	Bmm		
	5	PL05	345	288		
	7	PL07	495	358		
	8	PL08	530	393		
	10	PL10	640	463		
12	PL12	710	533			
				For the push button designation and symbols please see page 123 Colour:		
				□ Black and white		
				■ Start/Alarm green		
				■ Emergency red		





# Pendant stations

## PLB Series for control circuits

IP65 □ Double row



TECHNO-CONTROL EQUIPMENT

	PUSH BUTTONS	DESCRIPTION	REFERENCE NO.	WEIGHT gr
	2+2	For single-speed motor control 2 mechanically interlocked + 1 Start/Alarm + 1 Emergency stop ø 30 turn to release EN418	PLB04	560
	2+2	For two-speed motor control 2 mechanically interlocked + 1 Start/Alarm + 1 Emergency stop ø 30 turn to release EN418	PLB04D2	590
	4+2	For single-speed motor control 4 mechanically interlocked between pairs + 1 Start/Alarm + 1 Emergency stop ø 30 turn to release EN418	PLB06	560
	4+2	For two-speed motor control 4 mechanically interlocked between pairs + 1 Start/Alarm + 1 Emergency stop ø 30 turn to release EN418	PLB06D2	690
			PLB06D4	720
	6+2	For single-speed motor control 6 mechanically interlocked between pairs + 1 Start/Alarm + 1 Emergency stop ø 30 turn to release EN418	PLB08	840
	6+2	For two-speed motor control 6 mechanically interlocked between pairs + 1 Start/Alarm + 1 Emergency stop ø 30 turn to release EN418	PLB08D2	870
			PLB08D4	900
			PLB08D6	1.030
	8+2	For single-speed motor control No of operators mechanically interlocked + 1 Start/Alarm + 1 Emergency stop ø 30 turn to release EN418	PLB10	1.150
	10+2		PLB12	1.270
	12+2		PLB14	1.390

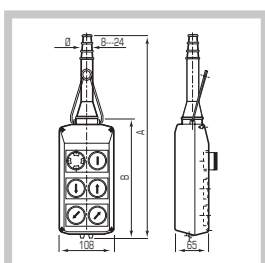

### DIMENSIONS

PUSH BUTTONS	REFERENCE NO.	Amm	Bmm
4	PLB04	345	185
6	PLB06	399	239
8	PLB08	453	293
10	PLB10	547	347
12	PLB12	601	401
14	PLB14	655	455

For the push button designation and symbols please see page 123  
Colour:

■ Black and white

■ Start/Alarm green

■ Emergency red



# Pendant stations

## PL series for control circuits

IP65 □ Enclosures

### SINGLE ROW



NO OF HOLES	CABLE ENTRY Ø	REFERENCE NO.	WEIGHT gr	MIN. PACK QTY.
5	7...18	PL05K	410	1
7	9...21	PL07K	540	1
8		PL08K	600	1
10		PL10K	700	1
12		PL12K	800	1

### DOUBLE ROW



NO OF HOLES	CABLE ENTRY Ø	REFERENCE NO.	WEIGHT gr	MIN. PACK QTY.
4	9...21	PLB04K	410	1
6		PLB06K	510	1
8		PLB08K	610	1
10	12...24	PLB10K	710	1
12		PLB12K	810	1
14		PLB14K	910	1

Enclosures are supplied with accessories with the exception of contact blocks and operators which must be purchased separately. Refer to page 121 for more information. For assembly instructions see page 124-125.

# Pendant stations

For control and direct switching power circuits  
Accessories



TECHNO-CONTROL EQUIPMENT

CONTACT BLOCKS		MULTI-SPEED CONTACT BLOCKS		LAMP HOLDERS		LENS CAP											
	1 NC 1 NO	PL004001 PL004002		2-SPEED 1NO+1NO PROGRESSIVE	PL004010		BA9s	PL004007		<table border="0"> <tr> <td>1</td> <td>2</td> <td></td> </tr> <tr> <td>3</td> <td>4</td> <td>5</td> </tr> </table>	1	2		3	4	5	PL00800
1	2																
3	4	5															
KEY SWITCH		ROTARY SWITCH		MUSHROOM OPERATOR Ø 30 TURN TO RELEASE EN418		MUSHROOM OPERATOR Ø 40 EN418											
	0-1 1-0-2	PL006001 PL006002		0-1 1-0-2	PL007001 PL007002		WITH VISION STANDARD	PL013001 PL013002		PL013003							
PUSH BUTTONS			COUPLING PLATE			INTERLOCK											
<b>COLOUR</b>	<b>REF. NO.</b>			2 HOLES 3 HOLES	PL003001 PL003002		TOP BOTTOM	PL011001 PL011002									
	PL005034																
	PL005035																
	PL005036																
	PL005037																
	PL005038																
With engraving	PL0050...*																
* See page 123																	
CABLE CLAMP LEVER		VERSIONS		CABLE SLEEVE													
	PL012001	P02 - PTRM For 7...14 Ø cable	12906011	P03 - PL05 For 7...18 Ø cable	12906006												
		PL07...PL12 PLB04-PLB06 For 9...21 Ø cable	12906004	PLB08-PLB14 For 12...24 Ø cable	12906005												

# Pendant stations

For control and direct switching power circuits

Composition

## PL SERIES

STANDARD VERSIONS

PL05	PL05D2	PL05D4
STOP 	STOP 	STOP 
LIFT UP 	1-2 SPEED LIFT UP 	1-2 SPEED LIFT UP 
LIFT DOWN 	1-2 SPEED LIFT DOWN 	1-2 SPEED LIFT DOWN 
HOIST RIGHT 	HOIST RIGHT 	1-2 SPEED HOIST RIGHT 
HOIST LEFT 	HOIST LEFT 	1-2 SPEED HOIST LEFT 

PL07	PL08	PL08D2	PL08D4	PL08D6	PL10	PL12
STOP 	START 	START 	START 	START 	START 	START 
LIFT UP 	STOP 	STOP 	STOP 	STOP 	STOP 	STOP 
LIFT DOWN 	LIFT UP 	LIFT UP 	1-2 SPEED LIFT UP 	1-2 SPEED LIFT UP 	LIFT UP 	LIFT UP 
O/H CRANE FORWARD 	LIFT DOWN 	LIFT DOWN 	1-2 SPEED LIFT DOWN 	1-2 SPEED LIFT DOWN 	LIFT DOWN 	LIFT DOWN 
O/H CRANE REVERSE 	O/H CRANE FORWARD 	O/H CRANE FORWARD 	1-2 SPEED O/H CRANE FORWARD 	1-2 SPEED O/H CRANE FORWARD 	O/H CRANE FORWARD 	LIFT UP FAST 
HOIST RIGHT 	O/H CRANE REVERSE 	O/H CRANE REVERSE 	1-2 SPEED O/H CRANE REVERSE 	1-2 SPEED O/H CRANE REVERSE 	O/H CRANE REVERSE 	LIFT DOWN FAST 
HOIST LEFT 	HOIST RIGHT 	HOIST RIGHT 	HOIST RIGHT 	1-2 SPEED HOIST RIGHT 	O/H CRANE FORWARD FAST 	O/H CRANE FORWARD 
	HOIST LEFT 	HOIST LEFT 	HOIST LEFT 	1-2 SPEED HOIST LEFT 	O/H CRANE REVERSE FAST 	O/H CRANE REVERSE 
					HOIST RIGHT 	O/H CRANE FORWARD FAST 
					HOIST LEFT 	O/H CRANE REVERSE FAST 

## PLB SERIES

STANDARD VERSIONS

PLB04	PLB04D2	PLB06D4	PLB08D4	PLB14	PLB10
START 	STOP 	START 	STOP 	START 	STOP 
LIFT UP 	LIFT DOWN 	1-2 SPEED LIFT UP 	1-2 SPEED LIFT DOWN 	UP FAST 	DOWN FAST 
LIFT UP 	LIFT DOWN 	1-2 SPEED O/H CRANE FORWARD 	1-2 SPEED O/H CRANE REVERSE 	LIFT UP 	LIFT DOWN 
O/H CRANE FORWARD 	O/H CRANE REVERSE 	HOIST UP 	HOIST DOWN 	UP 	DOWN 
START 	STOP 	START 	STOP 	UP FAST 	DOWN FAST 
LIFT UP 	LIFT DOWN 	1-2 SPEED O/H CRANE FORWARD 	1-2 SPEED O/H CRANE REVERSE 	LIFT UP 	LIFT DOWN 
O/H CRANE FORWARD 	O/H CRANE REVERSE 	HOIST UP FAST 	HOIST DOWN FAST 	UP 	DOWN 
START 	STOP 	START 	STOP 	UP 	DOWN 
LIFT UP 	LIFT DOWN 	1-2 SPEED O/H CRANE FORWARD 	1-2 SPEED O/H CRANE REVERSE 	UP 	DOWN 
O/H CRANE FORWARD 	O/H CRANE REVERSE 	HOIST UP FAST 	HOIST DOWN FAST 	UP 	DOWN 
START 	STOP 	START 	STOP 	UP 	DOWN 
LIFT UP 	LIFT DOWN 	1-2 SPEED O/H CRANE FORWARD 	1-2 SPEED O/H CRANE REVERSE 	UP 	DOWN 
O/H CRANE FORWARD 	O/H CRANE REVERSE 	HOIST UP FAST 	HOIST DOWN FAST 	UP 	DOWN 
START 	STOP 	START 	STOP 	UP 	DOWN 
LIFT UP 	LIFT DOWN 	1-2 SPEED O/H CRANE FORWARD 	1-2 SPEED O/H CRANE REVERSE 	UP 	DOWN 
O/H CRANE FORWARD 	O/H CRANE REVERSE 	HOIST UP FAST 	HOIST DOWN FAST 	UP 	DOWN 
START 	STOP 	START 	STOP 	UP 	DOWN 
LIFT UP 	LIFT DOWN 	1-2 SPEED O/H CRANE FORWARD 	1-2 SPEED O/H CRANE REVERSE 	UP 	DOWN 
O/H CRANE FORWARD 	O/H CRANE REVERSE 	HOIST UP FAST 	HOIST DOWN FAST 	UP 	DOWN 
START 	STOP 	START 	STOP 	UP 	DOWN 
LIFT UP 	LIFT DOWN 	1-2 SPEED O/H CRANE FORWARD 	1-2 SPEED O/H CRANE REVERSE 	UP 	DOWN 
O/H CRANE FORWARD 	O/H CRANE REVERSE 	HOIST UP FAST 	HOIST DOWN FAST 	UP 	DOWN 
START 	STOP 	START 	STOP 	UP 	DOWN 
LIFT UP 	LIFT DOWN 	1-2 SPEED O/H CRANE FORWARD 	1-2 SPEED O/H CRANE REVERSE 	UP 	DOWN 
O/H CRANE FORWARD 	O/H CRANE REVERSE 	HOIST UP FAST 	HOIST DOWN FAST 	UP 	DOWN 
START 	STOP 	START 	STOP 	UP 	DOWN 
LIFT UP 	LIFT DOWN 	1-2 SPEED O/H CRANE FORWARD 	1-2 SPEED O/H CRANE REVERSE 	UP 	DOWN 
O/H CRANE FORWARD 	O/H CRANE REVERSE 	HOIST UP FAST 	HOIST DOWN FAST 	UP 	DOWN 
START 	STOP 	START 	STOP 	UP 	DOWN 
LIFT UP 	LIFT DOWN 	1-2 SPEED O/H CRANE FORWARD 	1-2 SPEED O/H CRANE REVERSE 	UP 	DOWN 
O/H CRANE FORWARD 	O/H CRANE REVERSE 	HOIST UP FAST 	HOIST DOWN FAST 	UP 	DOWN 
START 	STOP 	START 	STOP 	UP 	DOWN 
LIFT UP 	LIFT DOWN 	1-2 SPEED O/H CRANE FORWARD 	1-2 SPEED O/H CRANE REVERSE 	UP 	DOWN 
O/H CRANE FORWARD 	O/H CRANE REVERSE 	HOIST UP FAST 	HOIST DOWN FAST 	UP 	DOWN 
START 	STOP 	START 	STOP 	UP 	DOWN 
LIFT UP 	LIFT DOWN 	1-2 SPEED O/H CRANE FORWARD 	1-2 SPEED O/H CRANE REVERSE 	UP 	DOWN 
O/H CRANE FORWARD 	O/H CRANE REVERSE 	HOIST UP FAST 	HOIST DOWN FAST 	UP 	DOWN 
START 	STOP 	START 	STOP 	UP 	DOWN 
LIFT UP 	LIFT DOWN 	1-2 SPEED O/H CRANE FORWARD 	1-2 SPEED O/H CRANE REVERSE 	UP 	DOWN 
O/H CRANE FORWARD 	O/H CRANE REVERSE 	HOIST UP FAST 	HOIST DOWN FAST 	UP 	DOWN 
START 	STOP 	START 	STOP 	UP 	DOWN 
LIFT UP 	LIFT DOWN 	1-2 SPEED O/H CRANE FORWARD 	1-2 SPEED O/H CRANE REVERSE 	UP 	DOWN 
O/H CRANE FORWARD 	O/H CRANE REVERSE 	HOIST UP FAST 	HOIST DOWN FAST 	UP 	DOWN 







































# Pendant stations

For control and direct switching power circuits  
Engravings



TECHNO-CONTROL EQUIPMENT

## FEM 9.941 STANDARD

UP	DOWN	FORWARD	REVERSE	LEFT	RIGHT	SPIN LEFT	SPIN RIGHT	GREEN START	GREEN START ALARM
 PL005004	 PL005019	 PL005012	 PL005027	 PL005023	 PL005008	 PL005031	 PL005016	 PL005001	 PL005002
 PL005005	 PL005020	 PL005013	 PL005028	 PL005024	 PL005009	 PL005032	 PL005017	 PL005003	 PL005034
 PL005006	 PL005021	 PL005014	 PL005029	 PL005025	 PL005010	 PL005033	 PL005018	 PL005035	 PL005036
 PL005007	 PL005022	 PL005015	 PL005030	 PL005026	 PL005011			 PL005037	 PL005038

**LASER ENGRAVING:** Optional engravings can be made to order according to special customer specification (min. quantity applies)

# Pendant stations

For control and direct switching power circuits

Assembly

## PL SERIES STANDARD VERSIONS

PL single row pendant station

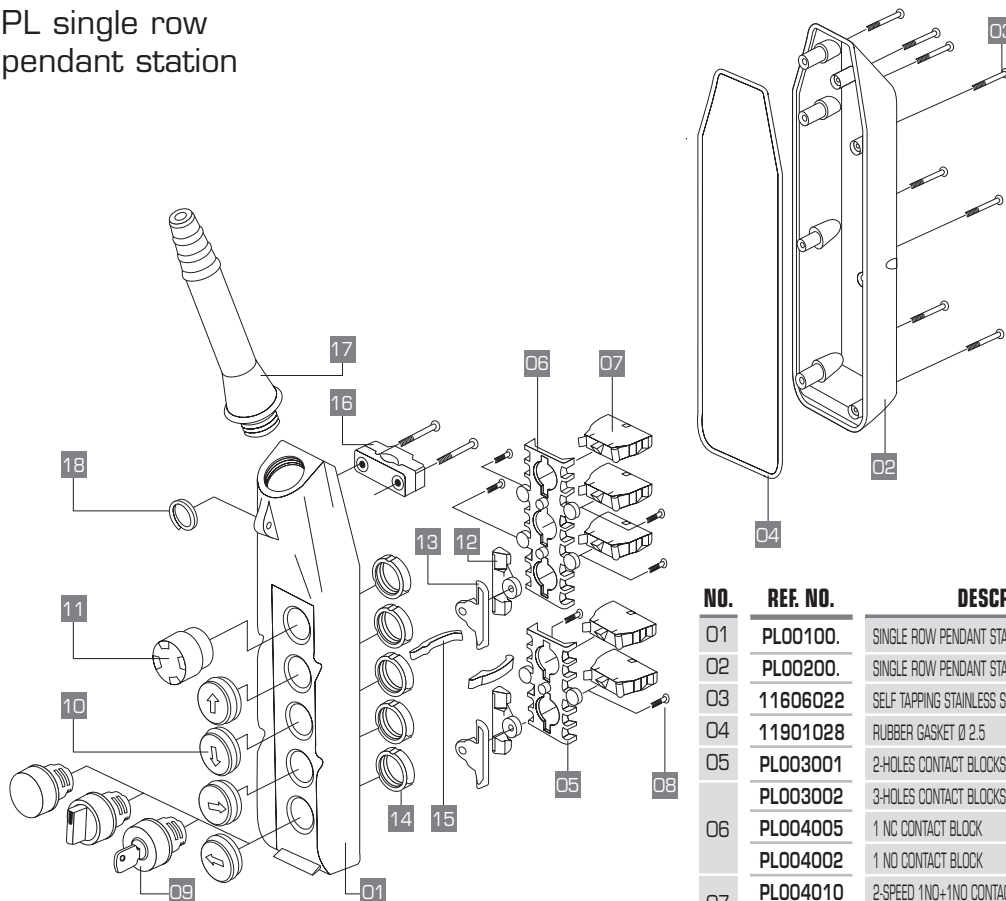

### ASSEMBLY INSTRUCTION FOR 1-2-SPEED CONTACT BLOCKS

**PL004010**

PL004003 1-SPEED

PL004004 2-SPEED

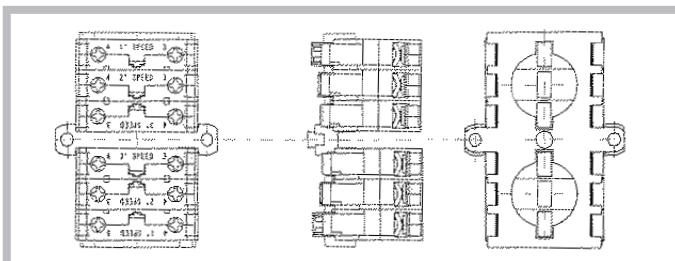

NO.	REF. NO.	DESCRIPTION	QTY.
01	PL00100.	SINGLE ROW PENDANT STATION COVER...PUSH BUTTONS	1
02	PL00200.	SINGLE ROW PENDANT STATION BASE...PUSH BUTTONS	1
03	11606022	SELF TAPPING STAINLESS STEEL SCREW 4X30	..
04	11901028	RUBBER GASKET Ø 2.5	MT..
05	PL003001	2-HOLES CONTACT BLOCKS SUPPORT	..
	PL003002	3-HOLES CONTACT BLOCKS SUPPORT	..
06	PL004005	1 NC CONTACT BLOCK	..
	PL004002	1 NO CONTACT BLOCK	..
07	PL004010	2-SPEED 1NO+1NO CONTACT BLOCK	..
	PL004007	LAMP HOLDER	..
08	11607007	SELF TAPPING SCREW 3.9X13	..
	PL00700.	ROTARY SWITCH	..
09	PL00600.	KEY SWITCH	..
	PL00800.	PILOT LIGHT	..
10	PL0050..	ENGRAVED PUSH BUTTONS	..
11	PL013001	MUSHROOM OPERATOR TURN TO RELEASE WITH VISION	1
12	PL011002	BOTTOM MECHANICAL INTERLOCK	..
13	PL011001	TOP MECHANICAL INTERLOCK	..
14	11705100	M22 ZAMA LOCK NUTS	..
15	PL012001	CABLE CLAMP LEVER	..
16	12904014	CABLE CLAMP	1
	12906006	PL05 CABLE SLEEVE	..
17	12906004	PL07 - PL08 CABLE SLEEVE	..
	12906005	PL10 - PL12 CABLE SLEEVE	..
18	12003009	SUNSPENSION RING	1

# Pendant stations

For control and direct switching power circuits

Assembly



TECHNO-CONTROL EQUIPMENT

## PLB SERIES STANDARD VERSIONS

PLB double row  
pendant station

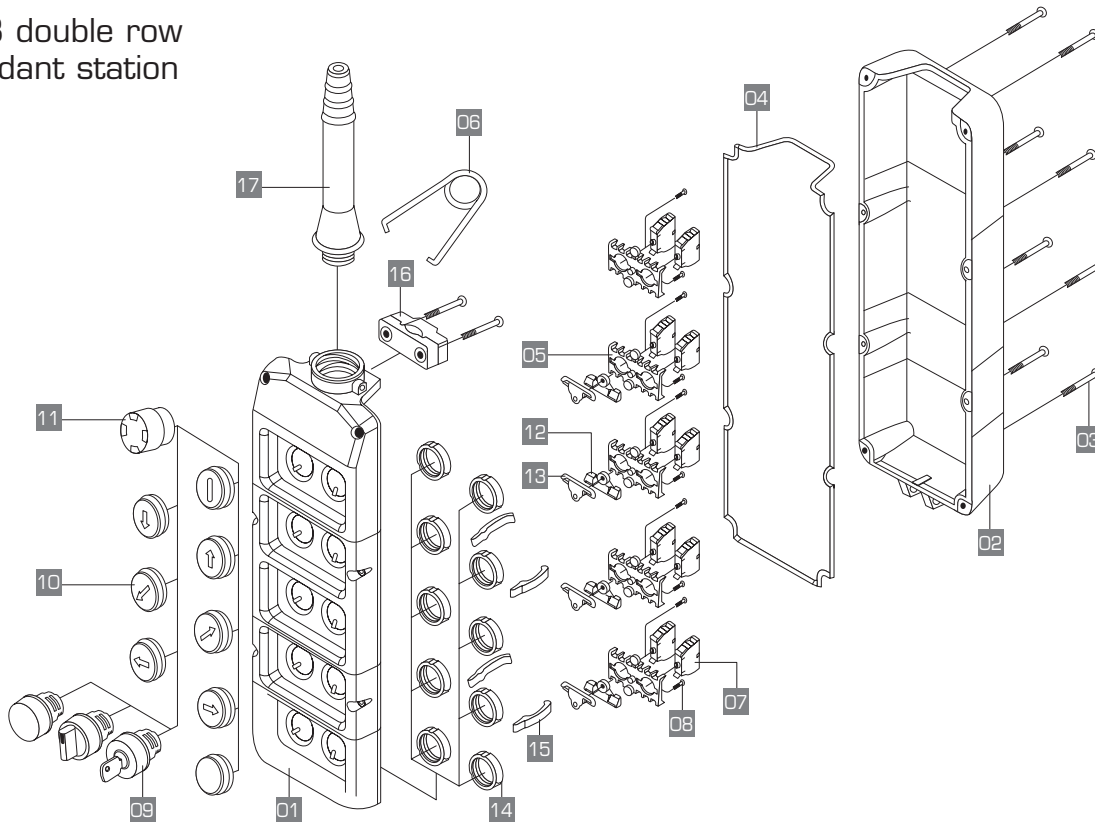

NO.	REF. NO.	DESCRIPTION	QTY.
01	1170807.	DOUBLE ROW PENDANT STATION COVER...PUSH BUTTONS	1
02	1171004.	DOUBLE ROW PENDANT STATION BASE...PUSH BUTTONS	1
03	11606022	SELF TAPPING STAINLESS STEEL SCREW 4X30	..
04	11901035	RUBBER GASKET Ø 2	MT..
05	PL003001	2-HOLE CONTACT BLOCKS SUPPORT	..
06	12001021	SUNSPENSION RING	1
07	PL004001	1 NC CONTACT BLOCK	..
	PL004002	1 NO CONTACT BLOCK	..
	PL004010	2-SPEED 1NO+1NO CONTACT BLOCK	..
	PL004007	LAMP HOLDER	..
08	11607007	SELF TAPPING SCREW 3.9X13	..
	PL00700..	ROTARY SWITCH	..
09	PL00600..	KEY SWITCH	..
	PL00800..	PILOT LIGHT	..
	PL0050...	ENGRAVED PUSH BUTTONS	..
10	PL013001	MUSHROOM OPERATOR TURN TO RELEASE WITH VISION	1
12	PL011002	BOTTOM MECHANICAL INTERLOCK	..
13	PL011001	TOP MECHANICAL INTERLOCK	..
14	11705100	M22 ZAMA LOCK NUTS	..
15	PL012001	CABLE CLAMP LEVER	..
16	12904008-09	CABLE CLAMP	1+1
17	12906004	PLB04 - 06 - 08 CABLE SLEEVE	..
	12906005	PLB10 - 12 - 14 CABLE SLEEVE	..

# Pendant stations

## DC30 series pendant stations for power circuits









IP65 □ direct switching

### GENERAL CHARACTERISTICS

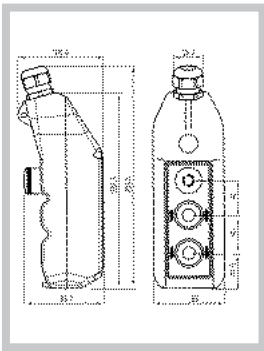
- Double insulated ABS enclosures
- IP65 protection rating according to IEC/EN 60529
- Ambient temperature: 

Operating	-25° +70° °C
Storage	-40° +70° °C
- Slow break or snap action double gap contacts
- Cable entry with M25 cable clamp
- Rated insulation voltage  $U_i$  500V
- Rated thermal current 25A
- Rated operating power:
 

3-phase - 2-pole	230V ac kW	2.2
	400V ac kW	2.2
3-phase - 3-pole	230V ac kW	3
	400V ac kW	3

2 directions mechanically interlocked	ENGRAVING	DESCRIPTION	REFERENCE NO.	WEIGHT gr	DIMENSIONS
		For single/three-phase 1-speed motor direct control	<b>DC30</b>	600	
		No. 1 Emergency stop ø 30 turn to release EN418 with 1NC+1NO contacts and:			
		3NO+1NC Contact block			
		4NO Contact block	<b>DC30.RG</b>	600	
		For single/three-phase 1-speed motor direct control	<b>DC30.GE</b>	600	
		No. 1 Emergency stop ø 30 turn to release EN418 with 3 NC con- tacts and:			
	3NO+1NC Contact block				





# Pendant stations

DC30 series pendant stations for power circuits

IP65  direct switching

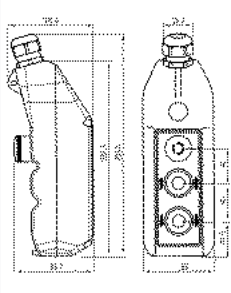

TECHNO-CONTROL EQUIPMENT

2 directions mechanically interlocked	ENGRAVING	DESCRIPTION	REFERENCE NO.	WEIGHT gr	DIMENSIONS
	  	<p>For 2-speed motor direct control</p> <p>No. 1 Emergency stop  <math>\varnothing</math> 30 turn to release                      EN418 with 3NC contacts and:</p> <hr/> <p>2NO+2NC                      Contact block</p>	<b>DC30D2</b>	650	

## WIRING DIAGRAMS - POWER CIRCUITS

For single-speed reversing motors  
 30205085 (3NO+1NC) contact block

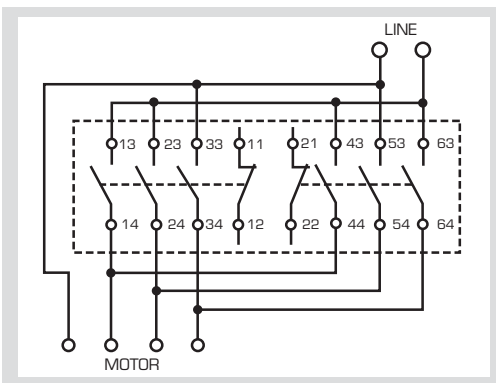

For single-speed reversing motors  
 30205087 (4NO) contact block

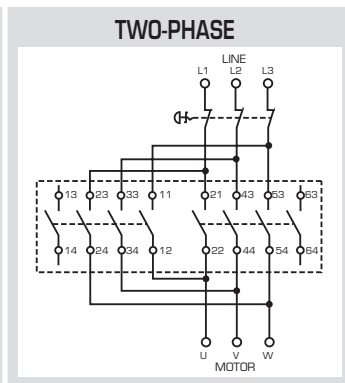
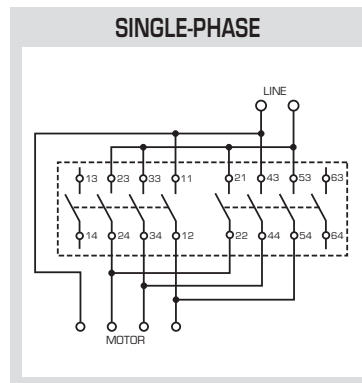

For two-speed reversing motors  
 30205086 contact block

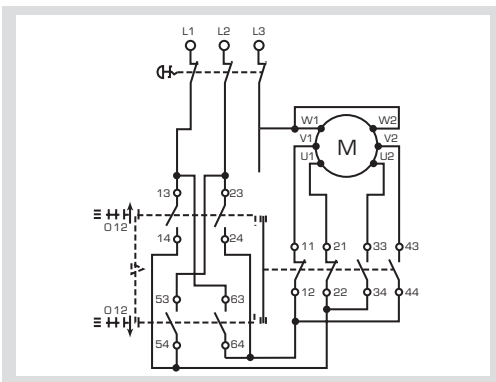

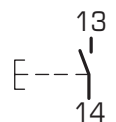

## AUXILIARY CIRCUIT WIRING DIAGRAM

SINGLE-SPEED 

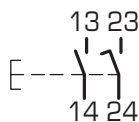

FAST MOVEMENT 



TWO-SPEED 

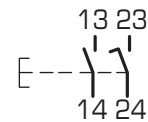

EMERGENCY 

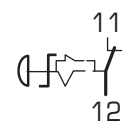



# Pendant stations

## DC30 series pendant stations for power circuits

Accessories



### CONTACT BLOCK FOR SINGLE-SPEED REVERSING MOTORS

3NO+1NC  
4NO

30205085  
30205087

### CONTACT BLOCK FOR TWO-SPEED REVERSING MOTORS

4NO  
(2NO+2NC PROGRESSIVE)

30205086

Exploded  
view

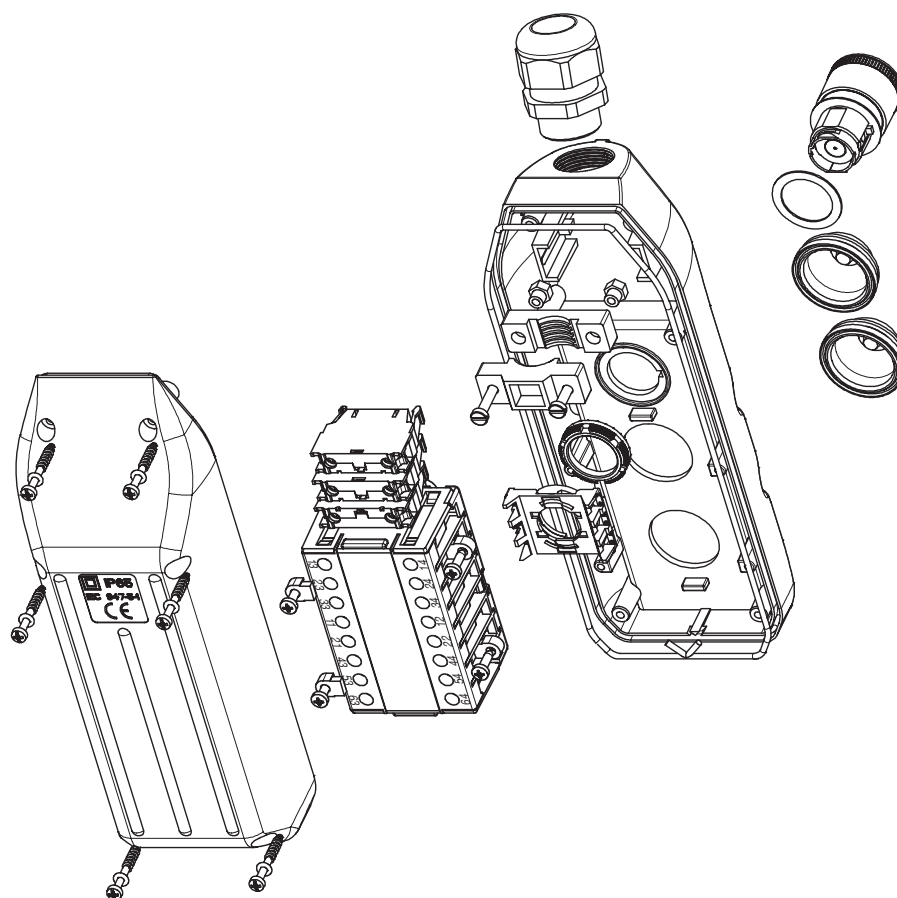

# Pendant stations

## TLP series push button stations for tail lifts









IP65 □ Spring loaded terminal contact blocks

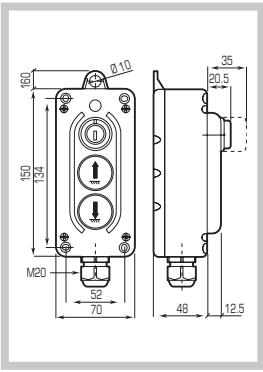

TECHNO-CONTROL EQUIPMENT

### GENERAL CHARACTERISTICS



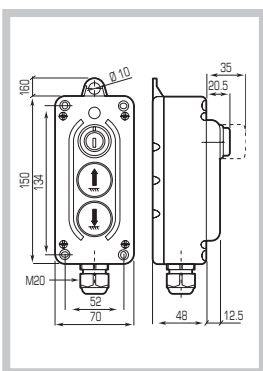











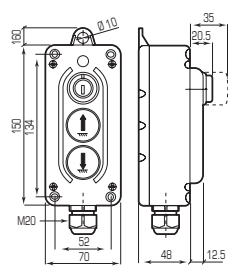





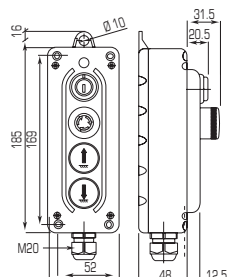

- Suitable for truck tail lifts
- Comply with UNI EN 1570 2001
- Heat resistant thermoplastic enclosure
- IP65 protection rating according to IEC/EN 60529
- Cable entry with No. 1 M20 cable clamp
- Suitable to be used both as pendant or fixed control station
- Laser printed push buttons

2 directions mechanically interlocked	ENGRAVING	DESCRIPTION	REFERENCE NO.	WEIGHT gr	DIMENSIONS
	  	<p>No. 1 UP push button with 1 NO contact</p> <hr/> <p>No. 1 COMMON push button with 1 NO contact</p> <hr/> <p>No. 1 DOWN push button with 1 NO contact</p>	<b>TLP3.A</b>	238	
	  	<p>No. 1 Emergency stop ø 30 turn to release EN418</p> <hr/> <p>No. 2 push buttons with 1 NO contact</p>	<b>TLP3.B</b>	255	

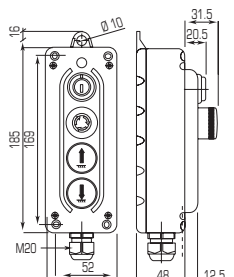
# Pendant stations

## TLP series push button stations for tail lifts

IP65 □ spring loaded terminal contact blocks

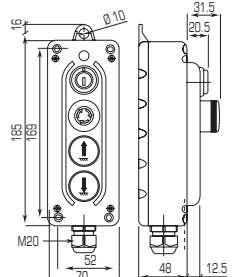
2 directions mechanically interlocked	ENGRAVING	DESCRIPTION	REFERENCE NO.	WEIGHT gr	DIMENSIONS
	  	<p>No. 1 90° angle key switch O-1 with 1 NO contact</p> <hr/> <p>No. 2 push buttons with 1 NO contact</p>	<p><b>TLP3.C</b></p>	<p>255</p>	
	   	<p>No. 1 Emergency stop ø 30 turn to release EN418</p> <hr/> <p>No. 1 UP push button with 1 NO contact</p> <hr/> <p>No. 1 COMMON push button with 1 NO contact</p> <hr/> <p>No. 1 DOWN push button with 1 NO contact</p>	<p><b>TLP4.A</b></p>	<p>314</p>	
	   	<p>No. 1 90° angle key switch O-1 with 1 NO contact</p> <hr/> <p>No. 1 Emergency stop ø 30 turn to release EN418</p> <hr/> <p>No. 2 push buttons with 1 NO contact</p>	<p><b>TLP4.B</b></p>	<p>314</p>	
	   	<p>No. 4 push buttons with 1 NO contact</p>	<p><b>TLP4.C</b></p>	<p>297</p>	

# Pendant stations

P02 - PTRM - P03 - DC16 - PL - DC30 - TLP Series

Characteristics\*



TECHNO-CONTROL EQUIPMENT

## GENERAL CHARACTERISTICS

<b>STANDARD COMPLIANCE</b>	
Material group	
Pollution class	
Flame resistance	UL94
Ambient temperature	°C
	°C
Climate resistance	IEC 68 part 2-8
	IEC 69 part 2-30
Cable entry	rubber cable sleeve
	cable clamp

## ELECTRICAL CHARACTERISTICS

<b>CONTACT BLOCKS</b>	
Rated insulation voltage $U_i$	V
Rated impulse voltage $U_{imp}$	kV
Rated thermal current $I_{th}$	A
Frequency	Hz
<b>Rated operating current <math>I_e</math>:</b>	
AC15 alternate current	V
DC13 direct current	A
	V
AC-3 alternate current	A
	230V kW
3-phase - 2-pole	400V kW
	230V kW
3-phase - 3-pole	400V kW
Conditional short circuit withstand current	A
Fuse rating gG	
Contact insulation resistance	mΩ
<b>Switching mechanism</b>	
<b>Positive operation</b>	
<b>Terminal type</b>	
<b>Terminal capacity:</b>	No. 1 Flexible and solid conductors min-max mm <sup>2</sup>
	No. 2 Flexible and solid conductors min-max mm <sup>2</sup>

P02-PTRM-P03 DC16-PL-TLP	DC30
IEC/EN60947-5-1	IEC/EN60947-3
II	II
3	3
VO	VO
Operating: -25+70	
Storage: -30 +70	
Hot damp	
Unsettled hot damp	
PL Ø 9...24	Ø 7...14
P02-P03-PTRM Ø 7...18	-
DC16 M25	M25
TLP M20	-

PL-P02-P03-PTRM-DC16-TLP	DC30
690	500
4	4
16	25
50	50
24   60   110   230   400   500   690	-
16   12   5   5   4   4   4	-
24   60   110   230	-
2   0,85   0,4   0,25	-
-	2.2
-	2.2
-	3
-	3
1000	1000
gG 10A-500V	aM 12A-500V
≤25	-
Slow break double gap contacts	
Positive opening NC contacts	-
M3.5 screw (spring loaded*)	M3.5 screw
1/2.5 (0.5/2.5*)	1/2.5
1/2.5 (0.5/2.5*)	1/2.5

\* TLP Series with spring loaded terminal contact blocks

# Reversing switches

## For I3ORZ series power circuits

IP65  Lever operated

### GENERAL CHARACTERISTICS

- Thermoplastic enclosure
- Lever operated with spring return in 0 position
- Coaxial shaft with safety limit switch
- IP65 protection rating according to IEC/EN 60529
- Thermoplastic enclosure
- Ambient temperature: operating -25 C°+70 C°  
storage -40 C° +70 C°
- Material class II, Pollution class 3 according to IEC/EN60947-1
- Slow break or snap action double gap contacts
- Cable entry with No. 2 cable clamps 3/8"

■ Comply with IEC/EN60947-3, UL508	IEC/EN60947-3, UL508
■ Rated insulation voltage Ui	500V
■ Rated thermal current Ith	25A
■ Rated operating power:	
3-phase – 2-pole	230V ac kW 2.2
	400V ac kW 2.2
3-phase – 3-pole	230V ac kW 3
	400V ac kW 3

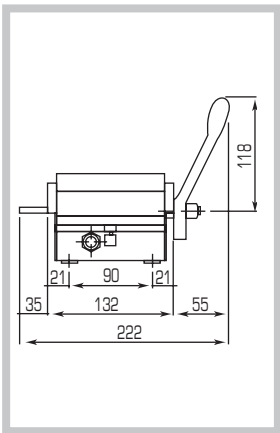
	DESCRIPTION	REFERENCE NO.	WEIGHT gr	DIMENSIONS
	<b>For single-speed motor control</b>			
	Lever operated reversing switch	<b>I3ORZ</b>	450	
	Spare components:			
	15° angled limit lever	<b>30301045</b>	10	
	45° angled limit lever	<b>30301076</b>	10	
Spare parts:				
Contact block	<b>30205083</b>	260		

# Limit switches

## FCR – FGR series

Table of contents



TECHNO-CONTROL EQUIPMENT



Rotary control switches with 300mm rods from 3 up to 5 positions. Control switches with rotary gear from 12 up to 200 rpm with 4 or 6 micro switches.

### TABLE OF CONTENTS

- |   |          |  |          |
|---|----------|--|----------|
| ■ FCR series rotary limit switches for control circuits | pag. 134 | ■ FGR series rotary gear limit switch for control circuits | pag. 135 |
|---|----------|--|----------|

# Rotary limit switches

## FCR series for control circuits

IP65 □

### GENERAL CHARACTERISTICS

- Self extinguishing thermoplastic housing VO UL94
- IP65 protection rating according to IEC/EN 60529
- Ambient temperature: operating  $-25^{\circ}$   $+55^{\circ}$  C  
storage  $-30^{\circ}$   $+70^{\circ}$  C
- Material class II, Pollution class 3 according to IEC/EN60947
- Slow break positive opening double gap contacts  $\rightarrow$
- No.1 cable entry 22,5  $\varnothing$

### ELECTRICAL CHARACTERISTICS

Comply with IEC/EN60947-3, UL508		
Certifications IMG, CCC, GOST, UL		
Rated insulation voltage $U_i$	V	690
Rated impulse withstand voltage $U_{imp}$	kV	4
Rated thermal current $I_{th}$	A	16
Frequency	Hz	50/60
Rated operating current: AC21A - AC22A	690V A	16
AC23A	3-phase - 3-pole	230V A/kW 13/4 400V A/kW 13/7,5
Rated short circuit withstand current (gG 20A-690V fuses)	kA	5



DESCRIPTION	REFERENCE NO.	WIRING DIAGRAM No.
<b>For single-speed motor control</b>		
3-position with mechanical interlock	FCR001	1
3-position with mechanical interlock	FCR002	2
4-position rotary	FCR003	3
4-position rotary	FCR004	4
4-position rotary	FCR005	5
<b>For two-speed motor control</b>		
4-position with mechanical interlock	FCR006	6

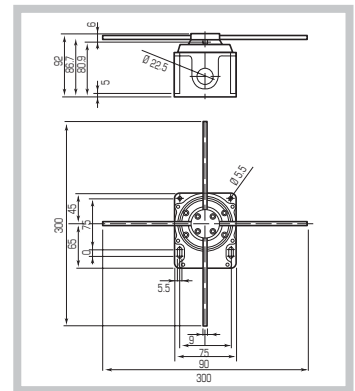

#### WIRING DIAGRAM 1

WITH MECHANICAL INTERLOCK

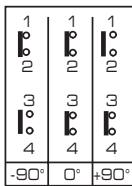

SINGLE-SPEED

#### WIRING DIAGRAM 2

WITH MECHANICAL INTERLOCK

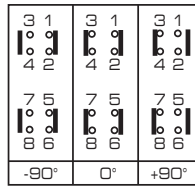

#### WIRING DIAGRAM 3

WITHOUT MECHANICAL INTERLOCK

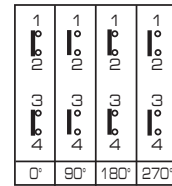

SINGLE-SPEED

#### WIRING DIAGRAM 4

WITHOUT MECHANICAL INTERLOCK

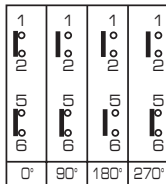

#### WIRING DIAGRAM 5

WITHOUT MECHANICAL INTERLOCK

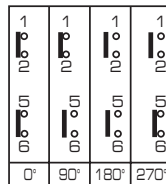

#### WIRING DIAGRAM 6

WITH MECHANICAL INTERLOCK

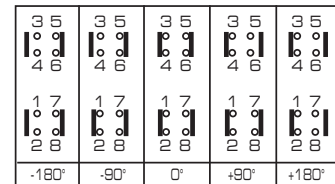

TWO-SPEED

# Rotary gear limit switches

## FGR series for control circuits

IP65 □



TECHNO-CONTROL EQUIPMENT

### GENERAL CHARACTERISTICS

This range is aimed at the control of rotating parts: crane rope drums, machinery, etc.

They are supplied with a micro ,adjustable by a tool, to set the contacts to open and close independent from one another according to the different requirements.

The FGR..B version is supplied with a coaxial shaft to use an encoder.

- Die cast main body with self extinguishing thermoplastic cover VO
- IP65 protection rating according to IEC/EN 60529
- Galvanised steel worm gear with ball bearings
- PA control cams with central stainless steel shaft mounted on ball bearings
- Cams and micrometric adjustment screws in PA
- Maximum number of operating contacts 6 (6 cams)
- No.2 cable entries with M20 cable glands
- Operating temperature -25° C + 70° C

### ELECTRICAL CHARACTERISTICS

- Comply with IEC/EN 61058-1, UL 1054
- Certifications IMQ, CCC, GOST, UL Recognized
- 1NC+1NO changeover switches (C form)
- Snap action contacts with positive opening NC contact ⊕
- Self cleaning silver alloy contacts
- Rated insulation voltage  $U_i$  250V
- Rated thermal current 8A
- Rated operating current:
  - resistive load  $I_e$  8A-250V ac
  - inductive load  $I_e$  3A-250V ac
- IEC/EN 61058-1 8(3)A-250V ac, UL 1054 8A-250Vac



### STANDARD VERSION

CAM/MOTORSHAFT REV RATIO	REFERENCE NO.		WEIGHT gr	MIN. PACK QTY.
	With 4 micro switches	With 6 micro switches		
1/12	FGR2006	FGR20066	1.100	1
1/33	FGR2007	FGR20076	1.100	1
1/50	FGR2008	FGR20086	1.100	1
1/100	FGR2009	FGR20096	1.100	1
1/200	FGR2010	FGR20106	1.100	1

### COAXIAL SHAFT VERSION

CAM/MOTORSHAFT REV RATIO	REFERENCE NO.		WEIGHT gr	MIN. PACK QTY.
	With 4 micro switches	With 6 micro switches		
1/12	FGR2006B	FGR2006B6	1.200	1
1/33	FGR2007B	FGR2007B6	1.200	1
1/50	FGR2008B	FGR2008B6	1.200	1
1/100	FGR2009B	FGR2009B6	1.200	1
1/200	FGR2010B	FGR2010B6	1.200	1



# Rotary gear limit switches

## FGR series for control circuits

IP65 □

### TRIP

The trip refer to the action of the cam on contact 1-2 (NC) of the micro-switches

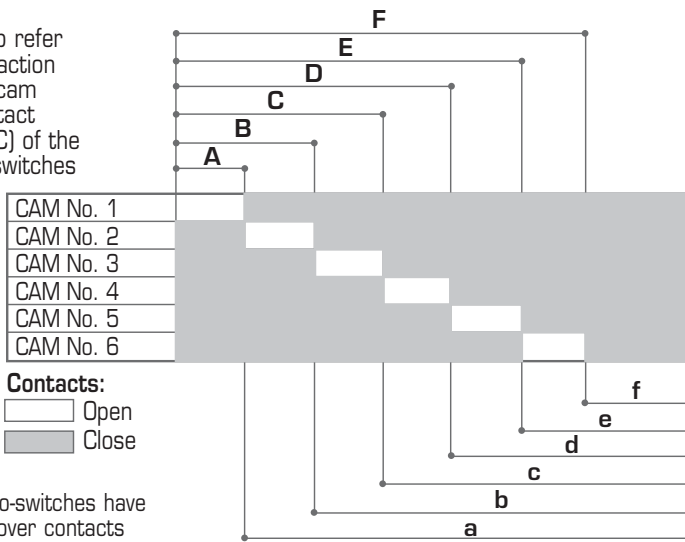

**NOTE:**  
all micro-switches have changeover contacts

### DIMENSIONS

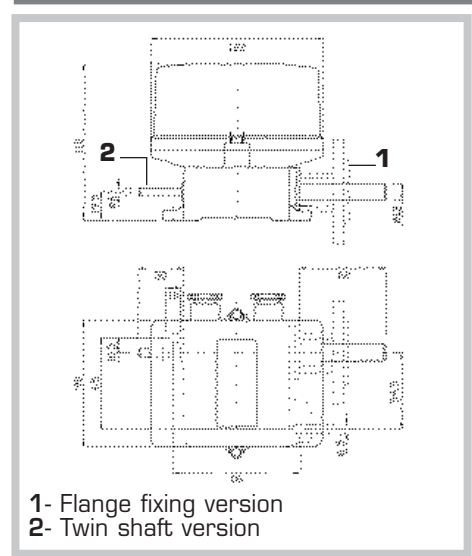

### REVOLUTIONS REFERRED TO THE CAMS'ACTIVATION

RPM	A	a	B	b	C	c	D	d	E	e	F	f
12 revs	1,25	10,75	2,5	9,5	3,75	8,25	5	7	6,25	5,75	7,5	4,5
33 revs	3,5	29,5	7	26	10,5	22,5	14	19	17,5	15,5	21	13
50 revs	5	45	10	40	15	35	20	30	25	25	30	20
100 revs	10	90	20	80	30	70	40	60	50	50	60	40
200 revs	20	180	40	160	60	140	80	120	100	100	120	80

### ACCESSORIES

The FLG flange in PA66, the Oldham coupling in PC reinforced with GF and the male connector in PA66 can be used on the main shaft. Special toothed cams can be made upon request.

#### FLANGE FLG

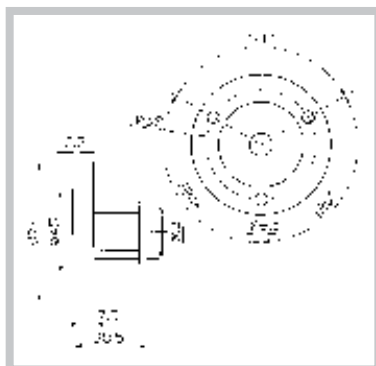

#### OLDHAM COUPLING FGH

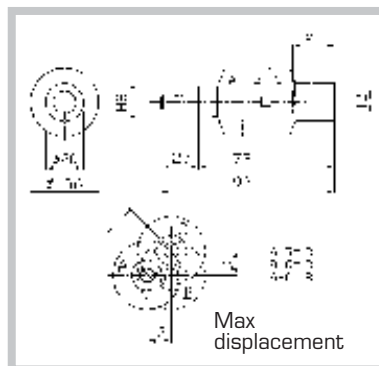

#### MALE COUPLING AM

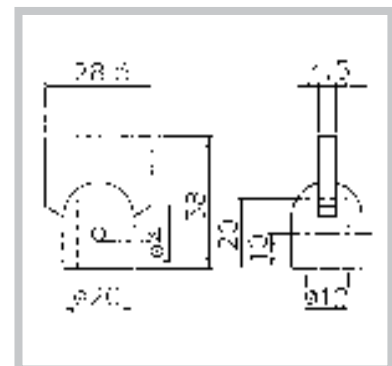

# Slip rings

## Scudo – Prisma - Navale series

Table of contents



TECHNO-CONTROL EQUIPMENT



20-50A slip rings from 3 up to 16 rings with open frame or protection rating up to IP65.

### TABLE OF CONTENTS

■ Scudo – Prisma - Navale series Characteristics	pag. 138	■ Scudo – Prisma - Navale series Accessories and spare parts	pag. 140
■ Scudo – Prisma - Navale series Versions	pag. 139		

# Slip rings

## Scudo – Prisma - Navale series

### Characteristics

Slip rings are used to transfer electrical signal and power energy between a stator (stationary portion of the slip ring) and a rotor. They are comprised of 3 or more graphite or metal contacts (brush) which rubs on the outside diameter of 3 or more metal rings. As the metal rings turn, the electrical current or signal is conducted through the brushes to the metal rings making the connection. Both parts can be either stator or rotor indifferently. Brushes are available in graphite (Prisma and Navale series) or copper (Scudo series) and can all be easily replaced.

#### OPERATING LIFE

The operating life of a slip ring is dependant upon the rotation speed and the dynamic stability. Hence it is important to make sure to avoid vibration of the rotor.

#### CURRENT RATING

Capacity can be increasing by connecting in series or parallel two or more slip rings.

#### GRAPHITE COLLECTORS

They are mainly used on low-medium speed applications. They are the most common in particular when more circuits are required as they ensure a very good connection, they withstand low and high temperatures, aggressive environments with presence of chemicals and humidity.

### CHARACTERISTICS

SCUDO	PRISMA	NAVALE
■ Rated insulation voltage Ui 690V	■ Rated insulation voltage Ui 690V	■ Rated insulation voltage Ui 690V
■ Rated operating voltage Ue 500Vac	■ Rated operating voltage Ue 500Vac	■ Rated operating voltage Ue 500Vac
■ Rated operating current Ie 20A	■ Rated operating current Ie 50A	■ Rated operating current Ie 50A
■ Close frame version with IP51 protection rating	■ Open frame	■ Close frame version with IEC/EN60529 IP65 protection rating
■ Modularity: from 3 up to 15 80mm Ø rings	■ Modularity: from 3 up to 16 100mm Ø rings	■ Modularity: from 3 up to 15 100 mm Ø rings
■ Cu collectors	■ Graphite collectors	■ Graphite collectors
■ 42 mm Ø shaft	■ 51 mm Ø shaft	■ 51 mm Ø shaft with roller bearings and O-rings
■ PVC 147 mm Ø housing and terminal cover		■ 280 mm Ø powder coated aluminium housing with protection against aggressive environments

# Slip rings

## Scudo - Prisma - Navale series

Versions



TECHNO-CONTROL EQUIPMENT

### 20A IP51 SCUDO SERIES



RINGS No.	REFERENCE No.	DIMENSION A
3	30402091	180
4	30402092	195
5	30402093	210
6	30402094	225
7	30402095	240
8	30402096	255
9	30402097	270
10	30402098	285
11	30402099	300
12	30402100	315
13	30402101	330
14	30402102	345
15	30402103	360

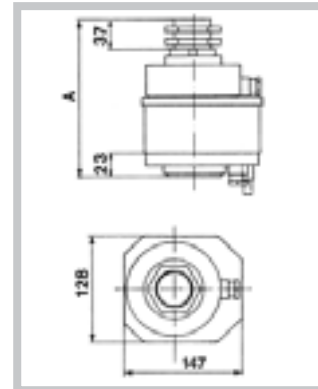

### 50A IPOO PRISMA SERIES



RINGS No.	REFERENCE No.	DIM. A	DIM. B
3	30402037	170	143
4	30402038	190	162
5	30402039	210	181
6	30402040	230	200
7	30402041	250	219
8	30402042	270	238
9	30402043	290	257
10	30402044	310	276
11	30402045	330	295
12	30402046	350	314
13	30402047	370	333
14	30402048	390	352
15	30402049	410	371
16	30402050	430	390

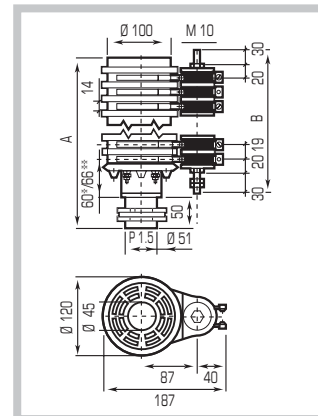

### 50A IP65 NAVALE SERIES



RINGS No.	REFERENCE No.	DIM. A	DIM. B
3	30403001	265	375
4	30403002		
5	30403003		
6	30403004		
7	30403005		
8	30403006		
9	30403007	470	570
10	30403008		
11	30403009		
12	30403010		
13	30403011		
14	30403012		
15	30403013		
16	30403014		

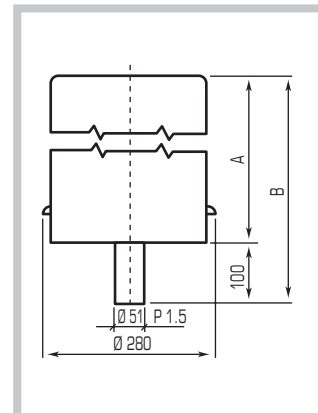

# Slip rings

## Scudo – Prisma - Navale series

Accessories and spare parts

### GRAPHITE COLLECTORS



### GRUPPO SPAZZOLE IN METALGRAFITE

■ 100 Ø yellow isolator	11702001	■ 6-ring collectors	12202017
■ Brush isolator	11702004	■ 7-ring collectors	12202018
■ Collector terminals	11702005	■ 8-ring collectors	12202019
■ 16-hole cable entry head	11708056	■ 9-ring collectors	12202020
■ Single collector	12202033	■ 10-ring collectors	12202021
■ Collector carbide	12202034	■ 11-ring collectors	12202022
■ Aluminium hexagon	21005005	■ 12-ring collectors	12202023
■ Aluminium fixing flange	21005007	■ 13-ring collectors	12202024
■ 100 Ø brass ring	21005010	■ 14-ring collectors	12202025
■ 3-ring collectors	12202015	■ 15-ring collectors	12202027
■ 4-ring collectors	12202016	■ 16-ring collectors	12202028
■ 5-ring collectors	12202026		

# Warning horns

## AA series

G100 IP65  - G75 IP30



TECHNO-CONTROL EQUIPMENT

### SINGLE TONE WARNING HORNS

Generally used in the industrial sector and handling equipment in general such as trucks, fork lifts, etc.

#### CHARACTERISTICS:

- Operation: continuous
- Frequency: 300-350 Hz G100 series, 50 Hz G75 series
- Pressure (at 1 meter): 95.3 dB (A), G100 series, 88 dB (A) G75 series
- Wall mounted
- IEC/EN60529 protection rating: IP65 G100 series, IP30 G75 series
- Terminal type: 2 way terminal bar G100 series, 3 way terminal (2P+E) bar G75 series

G100 series - Double insulated

#### G75 Ø 75



POWER SUPPLY Volt	CONSUMPTION mA	REFERENCE No.	WEIGHT gr	MIN. PACK QTY.
24 AC	190	G75.24	120	4/12
48 AC	80	G75.48		
110 AC	28	G75.110		
230 AC	20	G75.230		
24 DC	40	G75.24DC		
48 DC	-	G75.48DC		
110 DC	-	G75.110DC		
230 DC	-	G75.230DC		

#### G100 Ø 100



24 AC	415	G100.24	305	2/12
48 AC	210	G100.48		
110 AC	90	G100.110		
230 AC	42	G100.230		

#### BACK BOX



for G75 **11710009**  
for G100 **11710010**

#### DIMENSIONS

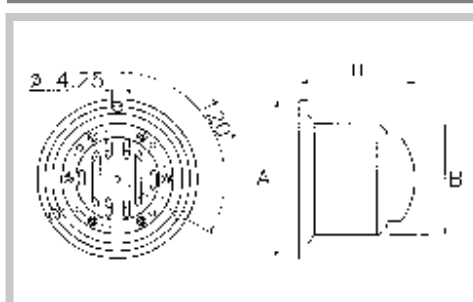

	G75	G100
A	Ø 95.5	Ø 120
B	Ø 76.5	Ø 95.5
H	56	58

Overall dimensions include the back box



# Energy and data transmission

28 - 30 - 41 - Wire rope - I-beam - TR 85 series

Table of contents



TECHNO-CONTROL EQUIPMENT



The festoon system includes 28, 30, 41 series c-rail cable trolleys; wire rope cable trolleys; I-beam cable trolleys. The TR85 series conductor rail range offers both plug-in (Line **A**) or continuous strip (Line **B**) type systems.

## TABLE OF CONTENTS

■ 28 series festoon system	pag. 144	■ TR85 series conductor rails	pag. 156
■ 30 series festoon system	pag. 147	■ TR85 series conductor rails Line <b>A</b> Plug-in type	pag. 157
■ 41 series festoon system	pag. 150	■ TR85 series conductor rails Line <b>B</b> Continuous strip type	pag. 160
■ Wire rope series	pag. 153	■ Accessories - TR85 series spare parts	pag. 163
■ Light I-beam series	pag. 154		
■ Heavy I-beam series	pag. 155		







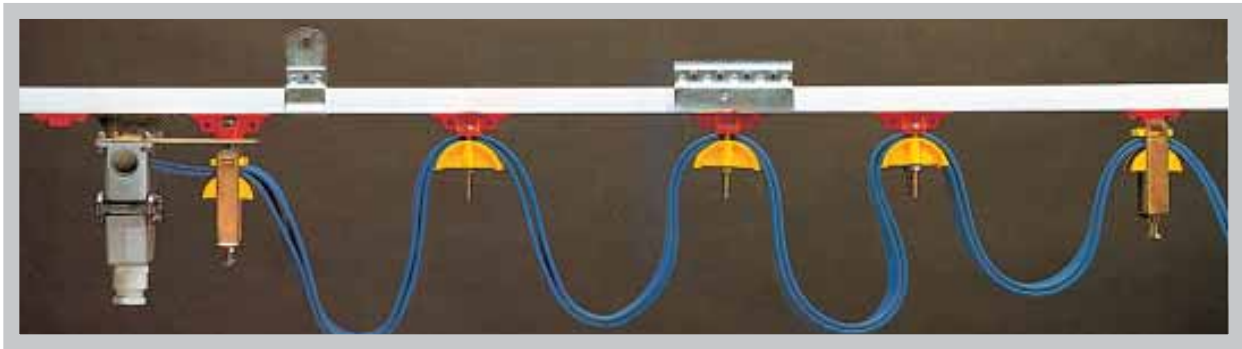

# Energy and data transmission

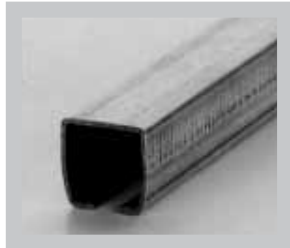
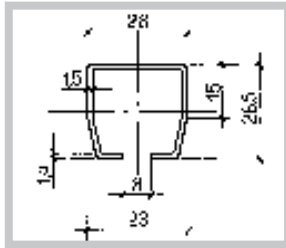
## 28 series

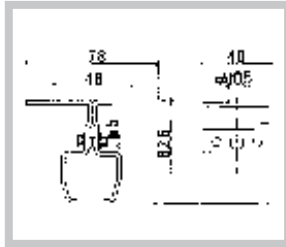
Festoon system

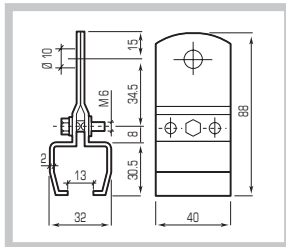

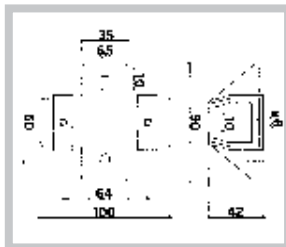







	DESCRIPTION	REFERENCE No.	MIN. PACK QTY.	DIMENSIONS
	<p><b>C-rail bars</b></p> <ul style="list-style-type: none"> <li>Material: galvanised steel</li> <li>Length: 4 m</li> <li>Weight: 3.92 kg</li> <li>Load capacity: 100 kg/m</li> </ul>	30603001/4	1	
	<p><b>Track support bracket</b> (2 pieces)</p> <ul style="list-style-type: none"> <li>Material: galvanised steel</li> <li>Max support spacing: 1 m (recommended)</li> </ul>	30603002	1	
	<p><b>Track support bracket</b> (2 pieces)</p> <ul style="list-style-type: none"> <li>Material: galvanised steel</li> <li>Max support spacing: 1 m (recommended)</li> </ul>	30603003	1	
	<p><b>Track coupler bracket</b> To join c-rails and suitable for supporting the track</p> <ul style="list-style-type: none"> <li>Material: PA 6</li> </ul>	30603004	1	

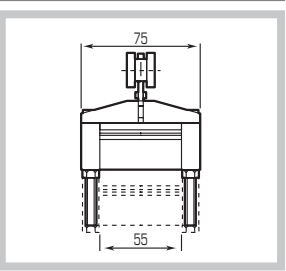

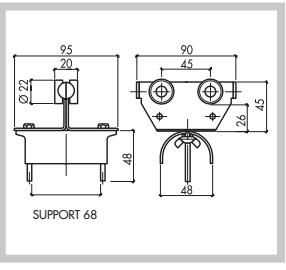
# Energy and data transmission

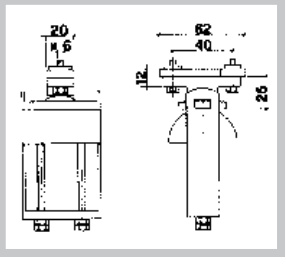
## 28 Series

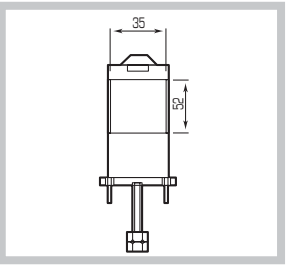
Festoon system

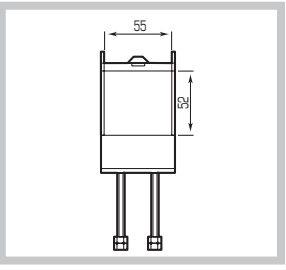
	DESCRIPTION	REFERENCE No.	MIN. PACK QTY.	DIMENSIONS
	<p><b>Light series trolley</b> Main body, saddle and wheels in PA for a considerable noise reduction</p> <ul style="list-style-type: none"> <li>■ Type of roller: PA roller. Travel speed 40 m/min.</li> <li>■ Load capacity: 10 Kg.</li> <li>■ 55 mm plastic saddle</li> </ul>	30603035	10	
	<p><b>Steel trolley</b></p> <ul style="list-style-type: none"> <li>■ Material: galvanised steel</li> <li>■ Type of roller: steel roller with ball bearings. Travel speed 80 m/min.</li> <li>■ Load capacity: 15 Kg.</li> <li>■ 68 mm steel saddle</li> </ul>	30603061	10	
	<p><b>End clamp</b></p> <ul style="list-style-type: none"> <li>■ Material: PA 6</li> <li>■ Load capacity: 15 Kg.</li> <li>■ 55 mm plastic saddle</li> <li>■ 68 mm plastic saddle</li> <li>■ Metal cable clip</li> </ul>	30603016 30603065 30603018	1 1 1	
	<p><b>40 mm plastic saddle</b></p> <ul style="list-style-type: none"> <li>■ Material: PA 6 and galvanised steel</li> </ul>	30603030	10	
	<p><b>55 mm plastic saddle</b></p> <ul style="list-style-type: none"> <li>■ Material: PA 6 and galvanised steel</li> </ul>	30603031	10	

# Energy and data transmission





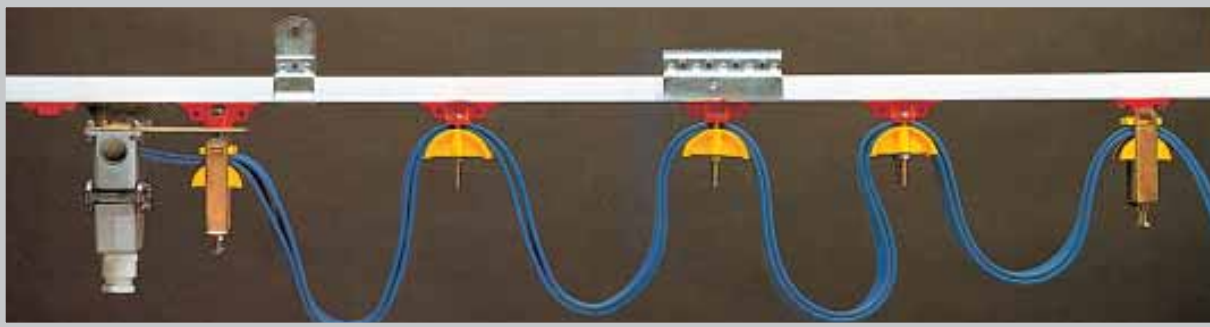

## 30 Series

Festoon system

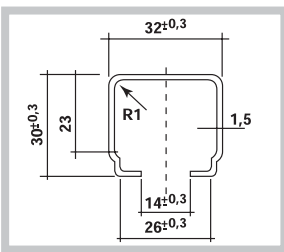

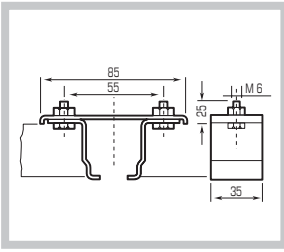
TECHNO-CONTROL EQUIPMENT

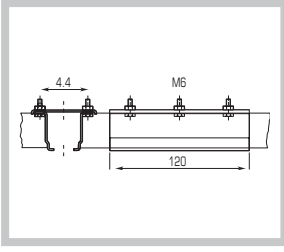

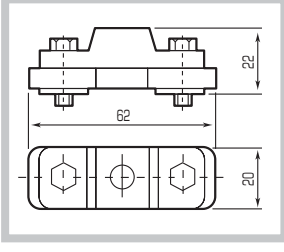



	DESCRIPTION	REFERENCE No.	MIN. PACK QTY.	DIMENSIONS
	<p><b>C-rail bars</b></p> <ul style="list-style-type: none"> <li>Material: galvanised steel</li> <li>Length: 4 m</li> <li>Weight: 5 kg</li> <li>Load capacity: 140 kg/m</li> </ul>	30607001	1	
	<p><b>Track support bracket</b> (2 pieces)</p> <ul style="list-style-type: none"> <li>Material: galvanised steel</li> <li>Max support spacing: 1 m (recommended)</li> </ul>	30607003	1	
	<p><b>Track coupler bracket</b> To join c-rails and suitable for supporting the track</p> <ul style="list-style-type: none"> <li>Material: Galvanised steel</li> </ul>	30607002	1	
	<p><b>End stop</b></p> <ul style="list-style-type: none"> <li>Material: PA 6</li> </ul>	30607005	1	

# Energy and data transmission

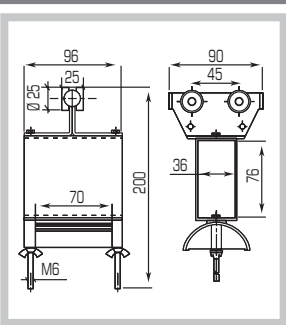
## 30 Series

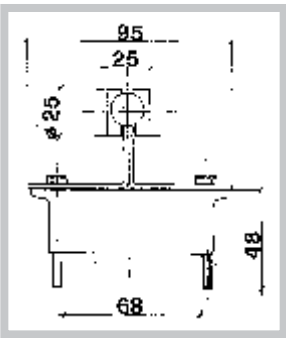
Festoon system

	DESCRIPTION	REFERENCE No.	MIN. PACK QTY.	DIMENSIONS
	<p><b>Towing trolley</b></p> <ul style="list-style-type: none"> <li>Material: galvanised steel</li> <li>Type of roller: steel roller with ball bearings. Travel speed 80 m/min.</li> <li>68 mm plastic saddle</li> </ul>	30607007	1	
	<p><b>Trolleys with Plug and Socket Connections</b></p> <ul style="list-style-type: none"> <li>To connect the festoon system to the pendant station</li> <li>68 mm plastic saddle</li> <li>16-pole</li> <li>24-pole</li> </ul>			30607008
	<p><b>Trolley</b></p> <ul style="list-style-type: none"> <li>Material: galvanised steel</li> <li>Type of roller: steel roller with ball bearings.</li> <li>68 mm steel saddle</li> <li>Material: PA 6</li> <li>Type of roller: PA roller.</li> <li>55 mm plastic saddle</li> <li>Material: galvanised steel</li> <li>Type of roller: PA roller.</li> <li>68 mm steel saddle</li> </ul>	30607010	10	
	<p><b>End clamp</b></p> <ul style="list-style-type: none"> <li>Material: PA 6/Galvanised steel</li> <li>68 mm steel saddle</li> </ul>	30607006	1	



# Energy and data transmission

## 30 Series

Festoon system

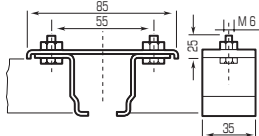

TECHNO-CONTROL EQUIPMENT

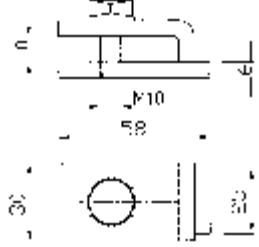
	DESCRIPTION	REFERENCE No.	MIN. PACK QTY.	DIMENSIONS
	<p><b>Support arm bracket</b></p> <ul style="list-style-type: none"> <li>Material: galvanised steel</li> </ul>	<p>30607004</p>	<p>1</p>	
	<p><b>Support arm clip</b></p> <ul style="list-style-type: none"> <li>Material: galvanised steel</li> </ul>	<p>30607012</p>	<p>1</p>	

### ASSEMBLY EXAMPLE

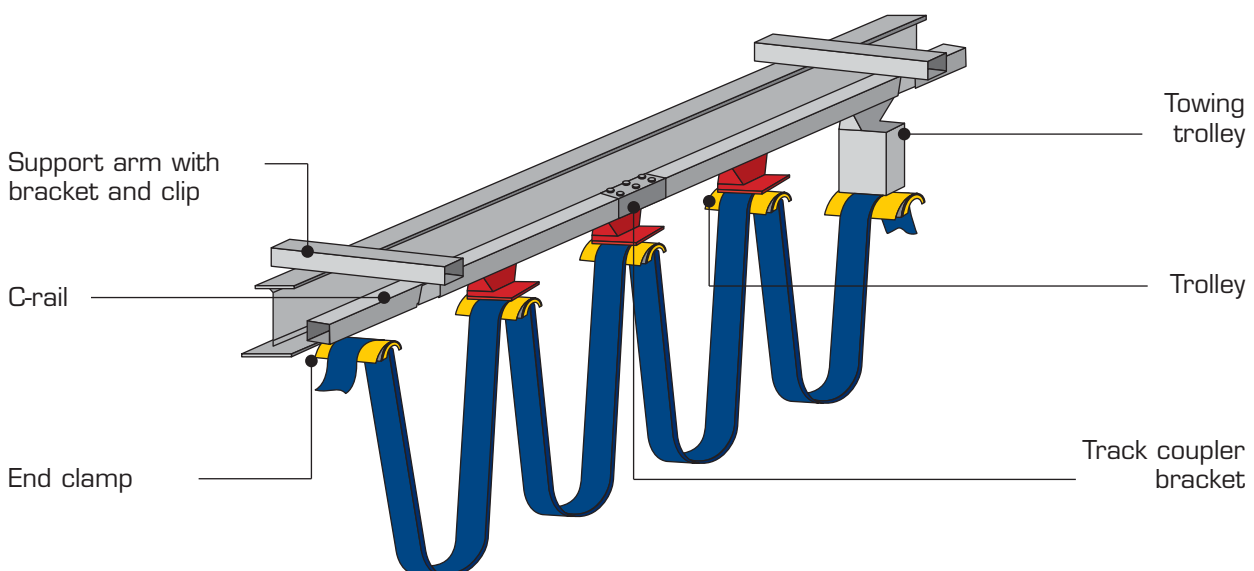

# Energy and data transmission

## 41 Series

Festoon system

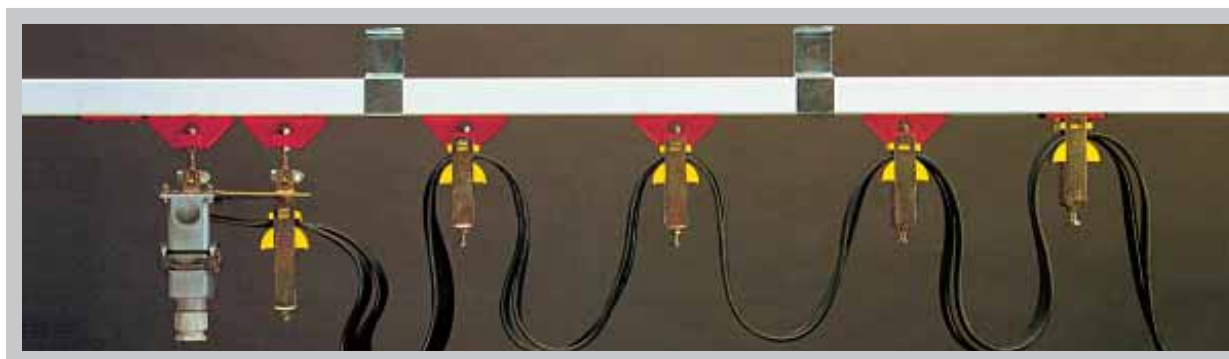

	DESCRIPTION	REFERENCE No.	MIN. PACK QTY.	DIMENSIONI
	<b>C-rail bars</b>			
	<ul style="list-style-type: none"> <li>Material: galvanised steel</li> <li>Length: 4 m</li> <li>Weight: 8 Kg</li> <li>Load capacity: 200 Kg/m</li> <li>90° curve 1.5 m radius*</li> <li>90° curve 1.2 m radius*</li> </ul>	30602001/4	1	
		30602054	1	
		30602055	1	
	<b>Track support bracket</b> (2 pieces)	30602004	1	
	<ul style="list-style-type: none"> <li>Material: galvanised steel</li> <li>Max support spacing: 1 m (recommended)</li> </ul>			
	<b>Track support bracket</b> (2 pieces)	30602003	1	
	<ul style="list-style-type: none"> <li>Material: galvanised steel</li> <li>Max support spacing: 1 m (recommended)</li> </ul>			
	<b>Track coupler bracket</b> To join c-rails	30602002	1	
	<b>Double track coupler bracket</b> Recommended for track over 50 m long	30602034	1	
	<ul style="list-style-type: none"> <li>Material: galvanised steel</li> </ul>			

\*The mechanical adjustment of the track is necessary when a curve is used





# Energy and data transmission

## 41 Series

Festoon system

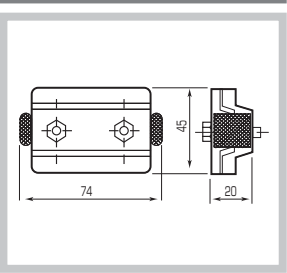

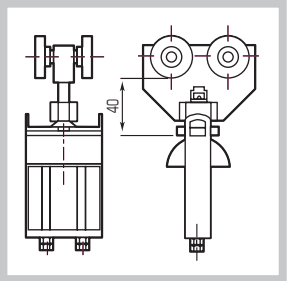
TECHNO-CONTROL EQUIPMENT

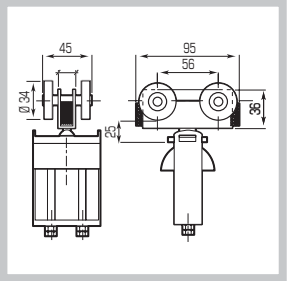



	DESCRIPTION	REFERENCE No.	MIN. PACK QTY.	DIMENSIONS
	<p><b>End stop</b></p> <ul style="list-style-type: none"> <li>Material: PA 6 Support PVC buffer</li> </ul>	30602038	1	
	<p><b>Flat cable trolley</b></p> <ul style="list-style-type: none"> <li>Material: PA 6</li> <li>Type of roller: PA roller. Travel speed 60 m/min.</li> <li>Load capacity: 15 Kg.</li> <li>40 mm plastic saddle</li> <li>55 mm plastic saddle</li> </ul>	30602012	10	
	<p><b>Round cable trolley</b></p> <ul style="list-style-type: none"> <li>Material: PA 6</li> <li>Type of roller: PA roller. Travel speed 60 m/min.</li> <li>Load capacity: 15 Kg.</li> <li>40 mm plastic saddle</li> <li>55 mm plastic saddle</li> </ul>	30602013	10	
	<p><b>Flat cable trolley</b></p> <ul style="list-style-type: none"> <li>Material: Galvanised steel</li> <li>Type of roller: steel roller with ball bearings. Travel speed 120 m/min.</li> <li>Load capacity: 25 Kg.</li> <li>40 mm plastic saddle</li> <li>55 mm plastic saddle</li> <li>68 mm plastic saddle</li> </ul>	30602076	10	
	<p><b>Round cable trolley</b></p> <ul style="list-style-type: none"> <li>Material: Galvanised steel</li> <li>Type of roller: steel roller with ball bearings. Travel speed 120 m/min.</li> <li>Load capacity: 25 Kg.</li> <li>40 mm plastic saddle</li> <li>55 mm plastic saddle</li> </ul>	30602082	10	
		30602086	10	
		30602083	10	

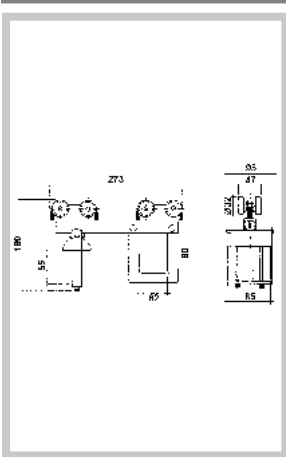

# Energy and data transmission

## 41 Series

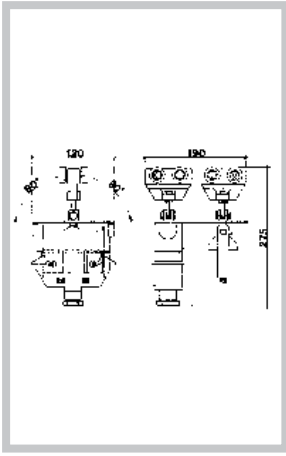
Festoon system

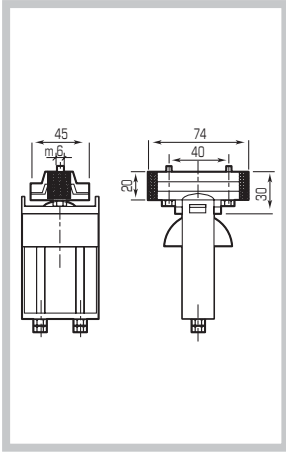
	DESCRIPTION	REFERENCE No.	MIN. PACK QTY.	DIMENSIONS
	<b>Towing trolley</b>			
	<ul style="list-style-type: none"> <li>■ Material: galvanised steel</li> <li>■ Type of roller: steel roller with ball bearings.</li> <li>■ 68 mm plastic saddle</li> </ul>	30602020	1	
	<ul style="list-style-type: none"> <li>■ Twin</li> <li>■ Single</li> </ul>	30602091	1	
	<b>Trolley with plug and socket connections</b> To connect the festoon system to the pendant station			
	<ul style="list-style-type: none"> <li>■ 68 mm plastic saddle</li> <li>■ 16-pole</li> <li>■ 24-pole</li> </ul>	30602036	1	
		30602040	1	
	<b>End clamp</b>			
	<ul style="list-style-type: none"> <li>■ Material: PA 6/Galvanised steel</li> <li>■ Load capacity: 15 Kg</li> <li>■ 40 mm plastic saddle</li> </ul>	30602006	1	
	<ul style="list-style-type: none"> <li>■ 55 mm plastic saddle</li> <li>■ 68 mm plastic saddle</li> </ul>	30602007	1	
		30602092	1	

# Energy and data transmission

## Wire rope series





Ø 8 rope festoon system

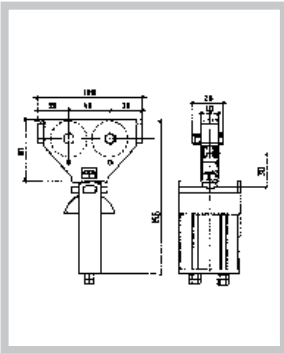

TECHNO-CONTROL EQUIPMENT

### CHARACTERISTICS

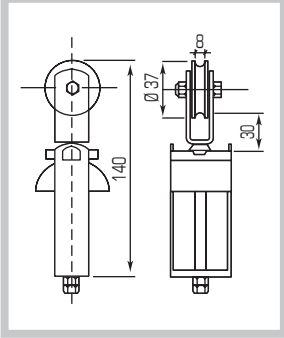
- Wire rope festoon systems are used in cases where c-rail and I-beam track power supplies are difficult to install.
- Rope diameter: Ø 8
- Trolleys for flat or round cables
- Travel speed: 40 m/min.
- Trolley load capacity: 8 kg

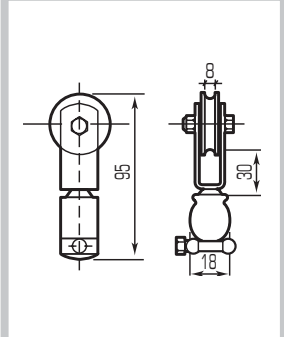
	DESCRIPTION	REFERENCE No.	MIN. PACK QTY.	DIMENSIONS
	<p><b>Two-roller trolley</b></p> <ul style="list-style-type: none"> <li>■ Material: galvanised steel/PA 6</li> <li>■ Type of roller: PA roller. Travel speed 40 m/min.</li> <li>■ Rotating 55 mm plastic saddle</li> <li>■ Load capacity: 8 kg</li> <li>■ Rope: Ø 8</li> </ul>	30604003	10	
	<p><b>Single-roller trolley</b></p> <ul style="list-style-type: none"> <li>■ Material: galvanised steel/PA 6</li> <li>■ Type of roller: PA roller. Travel speed 40 m/min.</li> <li>■ Rotating 40 mm plastic saddle</li> <li>■ Load capacity: 8 kg</li> <li>■ Rope: Ø 8</li> </ul>	30604005	10	
	<p><b>Single-roller trolley With metal cable clip</b></p> <ul style="list-style-type: none"> <li>■ Max cable diameter: 18 mm</li> <li>■ Material: galvanised steel</li> <li>■ Type of roller: PA roller. Travel speed 40 m/min.</li> <li>■ Load capacity: 8 kg</li> <li>■ Rope: Ø 8</li> </ul>	30604007	10	

# Energy and data transmission

## Light series

### I-beam

#### CHARACTERISTICS

- Festoon systems for IPE-IPN steel beam are suitable for heavy duty applications (motor power supply in steel plants, cranes, mills, docks, etc.)
- IPE-IPN 80-100 beam
- Travel speed: 120 m/min.
- Max trolley load capacity: 50 kg
- Maximum cable package window opening height of 40 mm for both flat and round cables

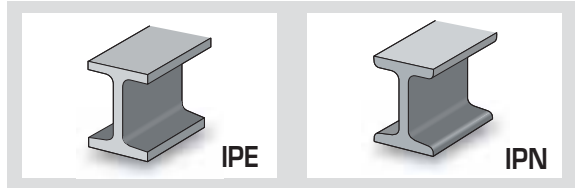

TROLLEY				
BEAM	IPE 80		IPN 80	
Saddle mm	55	85	55	85
PA rollers	30606003	30606005	30606004	30606006
Steel rollers	30606103	30606105	30606104	30606106
BEAM	IPE 100		IPN 100	
Saddle mm	55	85	55	85
PA rollers	30606011	30606013	30606012	30606014
Steel rollers	30606111	30606113	30606112	30606114

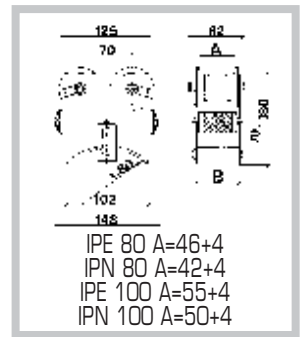

TOWING TROLLEY				
BEAM	IPE 80		IPN 80	
Saddle mm	55	85	55	85
PA rollers	30606033	30606035	30606034	30606036
Steel rollers	30606133	30606135	30606134	30606136
BEAM	IPE 100		IPN 100	
Saddle mm	55	85	55	85
PA rollers	30606041	30606043	30606042	30606044
Steel rollers	30606141	30606143	30606142	30606144

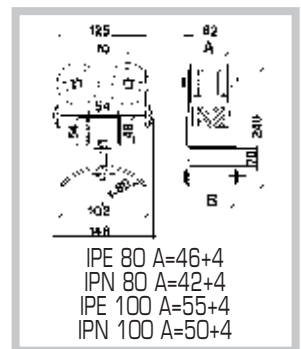

END CLAMP				
BEAM	IPE 80 - IPN80		IPE 100 - IPN 100	
Saddle mm	55	85	55	85
Reference No.	30606062	30606063	30606066	30606067

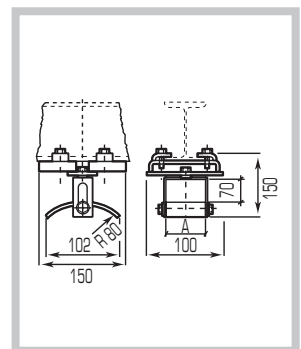

# Energy and data transmission

## Light series

### I-beam



TECHNO-CONTROL EQUIPMENT

### CHARACTERISTICS

- Festoon systems for IPE-IPN steel beams are suitable for heavy duty applications (motor power supply in steel plants, cranes, mills, docks, etc.)
- IPE-IPN 80-120 beam
- Travel speed: 120 m/min.
- Max trolley load capacity: 200 kg
- Maximum cable package window opening height of 50 mm for both flat and round cables

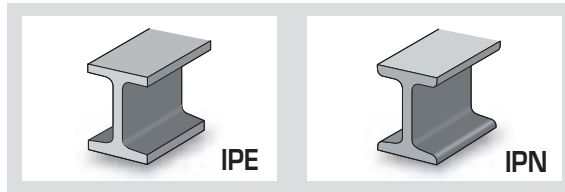

TROLLEY				
BEAM	IPE 80		IPN 80	
Saddle mm	100	160	160	180
Steel rollers	30605001	30605002	30605003	30605004
BEAM	IPE 100		IPN 100	
Saddle mm	160	180	160	180
Steel rollers	30605005	30605006	30605007	30605008
BEAM	IPE 120		IPN 120	
Saddle mm	160	180	160	180
Steel rollers	30605009	30605010	30605011	30605012

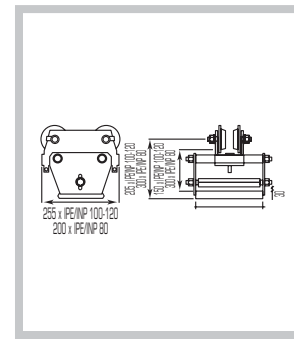

TOWING TROLLEY				
BEAM	IPE 80		IPN 80	
Saddle mm	100	160	160	180
Steel rollers	30605013	30605014	30605015	30605016
BEAM	IPE 100		IPN 100	
Saddle mm	160	180	160	180
Steel rollers	30605017	30605018	30605019	30605020
BEAM	IPE 120		IPN 120	
Saddle mm	160	180	160	180
Steel rollers	30605021	30605022	30605023	30605024

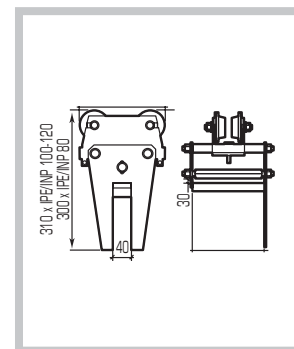

END CLAMP		
BEAM	IPE 80 - IPN 80	
Saddle mm	100	
Steel rollers	30605025	
BEAM	IPE 100 - IPN 100	
Saddle mm	160	
Steel rollers	30605027	
BEAM	IPE 120 - IPN 120	
Saddle mm	160	
Steel rollers	30605029	

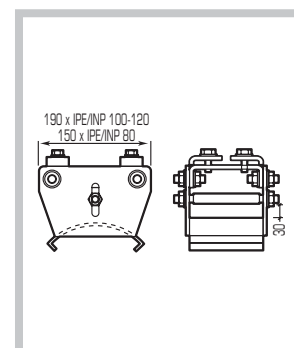

# Energy and data transmission

## TR85 Series

Conductor rails

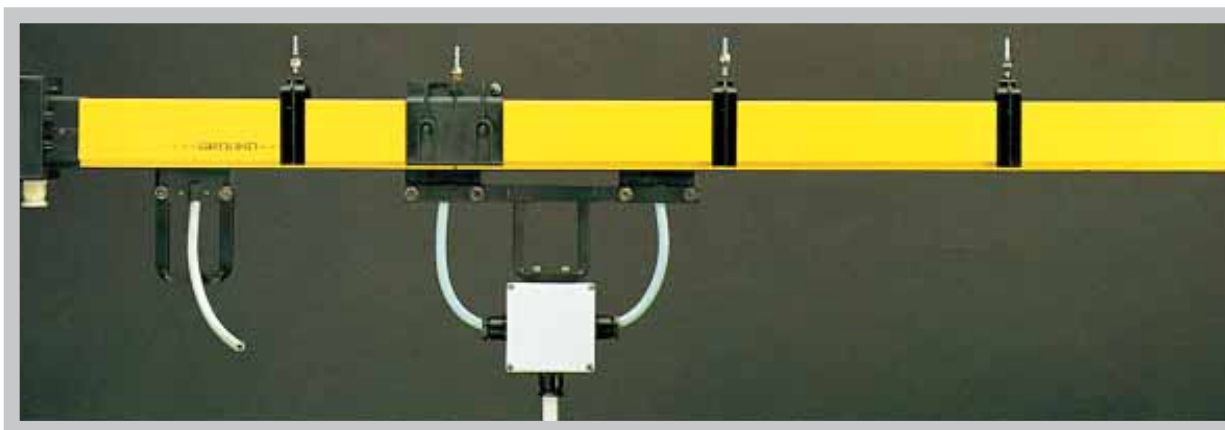

### CHARACTERISTICS

The TR85 series conductor rails are a modern and safe system for energy and data transmission for various type of equipment such as: CRANES - BRIDGE CRANES - CONVEYOR BELTS – CHAIN CONVEYORS - etc. The TR85 range comply with the relevant international standards ensuring operator safety, ease of installation and reliability. The system is available in the following versions:

- A) With conductors already inside the plastic casing. Copper strips are connected by means of dedicated terminals.
- B) With current strips to be pulled from a coil continuously into the pre-assembled plastic casings with the aid of a towing trolley in case of long systems.

#### PLASTIC CASING TECHNICAL CHARACTERISTICS: YELLOW R15C TYPE PVC

CHARACTERISTICS	TEST		METERING UNIT	
Transparency			ok/no	NO
Specific weight	ISO R	1183	Kg/dm <sup>3</sup>	1,44
Shore hardness	ISO R	868		D83
Vicat softening temperature - 5 kg	ISO R	306	°C	82
IZOD +23 °C	ISO R	180	Kg/Cm <sup>2</sup>	10
IZOD 0 °C	ISO R	180	Kg/Cm <sup>2</sup>	5,5
IZOD -10 °C	ISO R	180	Kg/Cm <sup>2</sup>	3
Ultimate tensile strength	ISO R	527	Kg/Cm <sup>2</sup>	430
Yield point	ISO R	527	Kg/Cm <sup>2</sup>	460
Modulus of elasticity	ISO R	178	Kg/Cm <sup>2</sup>	30000
Flammability	UL	94		V0
Flammability	DIN	4102		B2
Flammability	D.M.	6/7/'83		Cl

#### SEALING STRIP TECHNICAL CHARACTERISTICS: BLACK WE/706 TYPE PVC

Specific weight	1,45/Cm <sup>3</sup>
Shore hardness at 15"	81
Breaking point	1,45
Elongation	340%
Cold resistance	-30 °C
Volume resistance	3x10 <sup>13</sup>
Protection rating	IP20 - IP23

#### TECHNICAL DATA

Operating voltage 600V

Operating temperature -30°C +55°C (-22°F +130°F)

CURRENT RATING AMP	CONDUCTOR CROSS SECTIONAL AREA mm <sup>2</sup>	IMPEDENCE Ω/ m.	RESISTANCE V/m./Amp.
40	9,3	2.10 <sup>3</sup>	0,00346
60	12,4	1,75.10 <sup>3</sup>	0,00303
70	15,5	1,30.10 <sup>3</sup>	0,00250
80	17	1,18.10 <sup>3</sup>	0,00204
100	21,7	1.10 <sup>3</sup>	0,00173
140	31	0,75.10 <sup>3</sup>	0,00123

# Energy and data transmission

## TR85 Series

Conductor rails - Line A "Plug-in" type



TECHNO-CONTROL EQUIPMENT



### CONDUCTOR RAIL

Ends with provision for the TR 8515 joint clamps

LENGTH (m)	POLES	CURRENT RATING		
		40A	60A	80A
3	4	TR85404C3	TR85604C3	TR85804C3
	5	TR85405C3	TR85605C3	TR85805C3
4	4	TR85404C	TR85604C	TR85804C
	5	TR85405C	TR85605C	TR85805C
LENGTH (m)	POLES	CURRENT RATING		
		100A	140A	
3	4	TR851004C3	TR851404C3	
	5	TR851005C3	TR851405C3	
4	4	TR851004C	TR851404C	
	5	TR851005C	TR851405C	

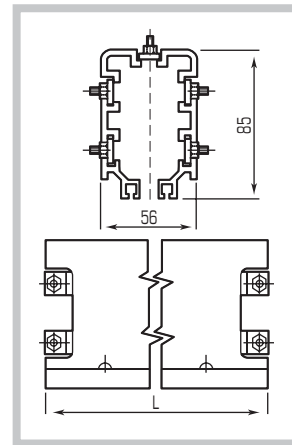

### END FEED

Standard length 2 m

LENGTH (m)	POLES	CURRENT RATING		
		40A	60A	80A
2	4	TR85404A2	TR85604A2	TR85804A2
	5	TR85405A2	TR85605A2	TR85805A2
LENGTH (m)	POLES	CURRENT RATING		
		100A	140A	
2	4	TR851004A2	TR851404A2	
	5	TR851005A2	TR851405A2	

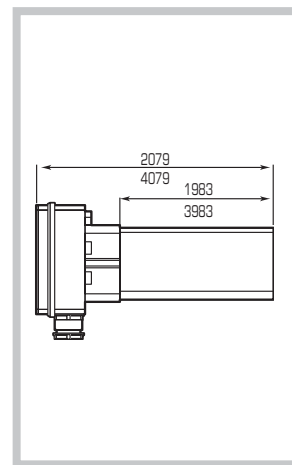

### END CAP

Standard length 2 m

LENGTH (m)	POLES	CURRENT RATING		
		40A	60A	80A
2	4	TR85404F2	TR85604F2	TR85804F2
	5	TR85405F2	TR85605F2	TR85805F2
LENGTH (m)	POLES	CURRENT RATING		
		100A	140A	
2	4	TR851004F2	TR851404F2	
	5	TR851005F2	TR851405F2	

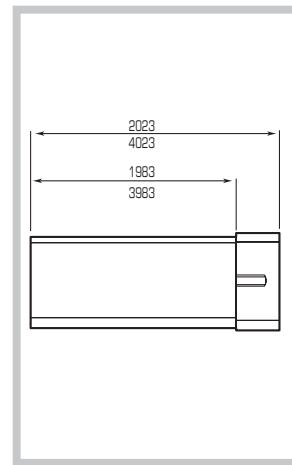

# Energy and data transmission

## TR85 Series

Conductor rails - Line A "Plug-in" type

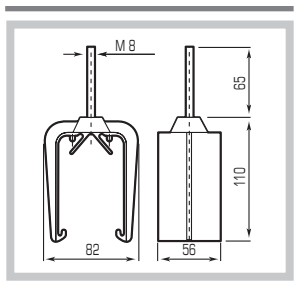
	DESCRIPTION	REFERENCE No.	MIN. PACK QTY.	DIMENSIONS
	<p><b>Hanger clamp</b></p> <ul style="list-style-type: none"> <li>Material: PA 66</li> <li>Max support spacing: 2 m (recommended)</li> </ul>	TR8502	1	
	<p><b>Joint cover</b></p> <ul style="list-style-type: none"> <li>Material: PA 6</li> </ul>	TR8504	1	
	<p><b>Steel hanger clamp</b></p> <ul style="list-style-type: none"> <li>Material: Galvanised steel</li> </ul>	TR8525	1	
	<p><b>Towing arm</b></p> <ul style="list-style-type: none"> <li>Material: Galvanised steel</li> </ul>	TR8510	1	
	<p><b>Towing arm bracket</b></p> <p>For 35A and 70A current collectors</p> <ul style="list-style-type: none"> <li>Material: Galvanised steel</li> </ul>	TR8508	1	







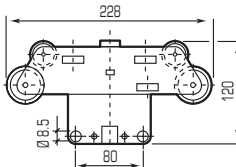

# Energy and data transmission

## TR85 Series

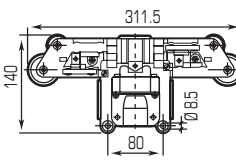
Conductor rails - Line A "Plug-in" type

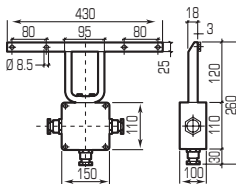

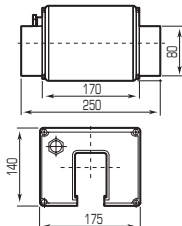
TECHNO-CONTROL EQUIPMENT

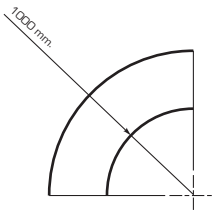
	DESCRIPTION	REFERENCE No.	MIN. PACK QTY.	DIMENSIONS
	<p><b>35A current collector trolley</b></p> <ul style="list-style-type: none"> <li>Fully insulated body with copper graphite collector shoes. Wheels equipped with ball bearings.</li> </ul> <p>■ 35A 3-pole ■ 35A 4-pole ■ 35A 5-pole</p>	<p>TR8521 TR8511 TR8512</p>	<p>1 1 1</p>	
	<p><b>70A current collector trolley</b></p> <ul style="list-style-type: none"> <li>Fully insulated body with copper graphite collector shoes. Wheels equipped with ball bearings. For current rating over 70A, connect more trolleys on parallel.</li> </ul> <p>■ 35A 3-pole ■ 35A 4-pole ■ 35A 5-pole</p>	<p>TR8522 TR8518 TR8519</p>	<p>1 1 1</p>	
	<p><b>Support for double towing arm</b> Connects two trolleys in parallel to increase the current rating</p> <p>■ For 35A and 70A current collector trolleys</p>	<p>TR8523</p>	<p>1</p>	
	<p><b>In-line feed</b></p>	<p>TR8526</p>	<p>1</p>	
	<p><b>Curve</b></p> <ul style="list-style-type: none"> <li>Curve radius: Special radiuses can be made to order.</li> <li>Minimum Radius: 1 m</li> </ul>	<p>TR8529</p>	<p>1</p>	



# Energy and data transmission

## TR85 Series

Conductor rails - Line B "Continuous strip" type



### CONDUCTOR RAIL

Standard length 4 m

LENGTH (m)		CURRENT RATING		
		70A	100A	140A
4	4	TR85704	TR851004	TR851404
	5	TR85705	TR851005	TR851405

Conductors are supplied separately. The copper strip is pulled from a coil into the plastic casing with the aid of the TR8513 de-coil unit and TR8514 strip insertion trolley

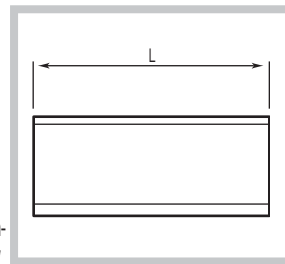

DESCRIPTION	REFERENCE No.	MIN. PACK QTY.	DIMENSIONS
End feed	TR8503	1	



<b>End cap</b> <ul style="list-style-type: none"> <li>To close the ends of the line</li> <li>Material: PA 66/FV</li> </ul>	TR8506	1	
---	--------	---	--



<b>Joint cover</b> To join the ends of two conductor rails. If fixed to the support arm, it acts as a fixed point to distribute the linear expansion. <ul style="list-style-type: none"> <li>Material: PA 66</li> </ul>	TR8501	1	
---	--------	---	--



<b>Steel joint cover</b> To join the ends of two conductor rails. <ul style="list-style-type: none"> <li>Material: Galvanised steel</li> </ul>	TR8524	1	
--	--------	---	--







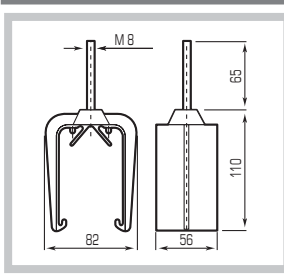

# Energy and data transmission

## TR85 Series

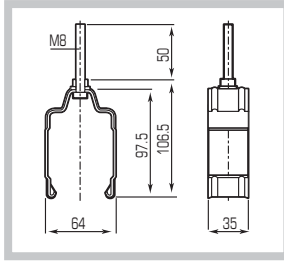
Conductor rails - Line B "Continuous strip" type

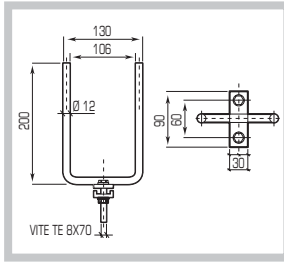

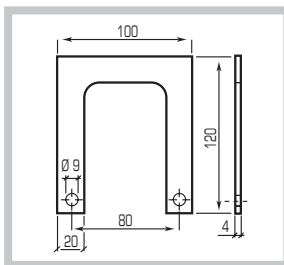

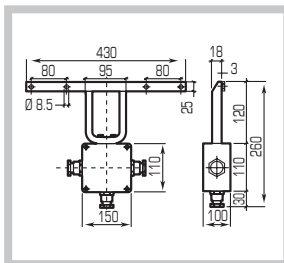



TECHNO-CONTROL EQUIPMENT

	DESCRIPTION	REFERENCE No.	MIN. PACK QTY.	DIMENSIONS
	<p><b>Hanger clamp</b> Allows the linear expansion due to climate conditions</p> <ul style="list-style-type: none"> <li>Max support spacing: 2 m (recommended)</li> <li>Material: PA 66</li> </ul>	TR8502	1	
	<p><b>Steel hanger clamp</b></p> <ul style="list-style-type: none"> <li>Material: Galvanised steel</li> </ul>	TR8525	1	
	<p><b>Towing arm</b></p> <ul style="list-style-type: none"> <li>Material: Galvanised steel</li> </ul>	TR8510	1	
	<p><b>Towing arm bracket</b> For 35A and 70A current collector trolleys</p> <ul style="list-style-type: none"> <li>Material: Galvanised steel</li> </ul>	TR8508	1	
	<p><b>Support for double towing arm</b> For 35A and 70A current collector trolleys</p> <ul style="list-style-type: none"> <li>Material: Galvanised steel</li> </ul>	TR8523	1	

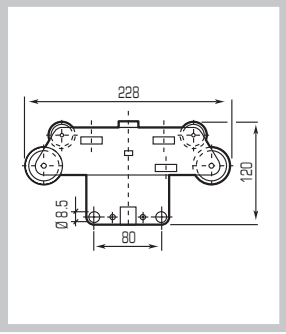
# Energy and data transmission

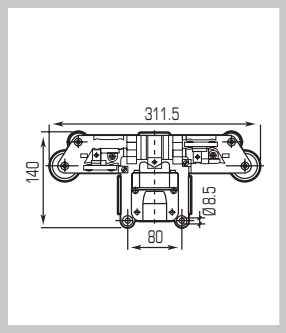
## TR85 Series

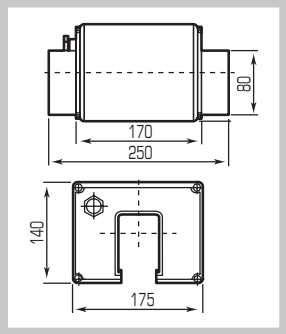
Conductor rails - Line B "Continuous strip" type

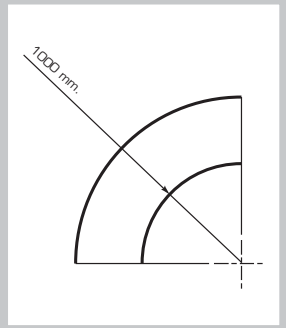
	DESCRIPTION	REFERENCE No.	MIN. PACK QTY.	DIMENSIONS
	<b>35A current collector trolley</b> Fully insulated body with copper graphite collector shoes. Wheels equipped with ball bearings.			
	■ 35A 3-pole	TR8521	1	
	■ 35A 4-pole	TR8511	1	
	■ 35A 5-pole	TR8512	1	
	<b>70A current collector trolley</b> Fully insulated body with copper graphite collector shoes. Wheels equipped with ball bearings. For current rating over 70A, connect more trolleys in parallel.			
	■ 70A 3-pole	TR8522	1	
	■ 70A 4-pole	TR8518	1	
	■ 70A 5-pole	TR8519	1	
	<b>In-line feed</b>	TR8526	1	
	<b>Curve</b> ■ Curve radius: Special radiuses can be made to order. Minimum Radius: 1 m	TR8529	1	

# Energy and data transmission

## TR85 series

Conductor rails – Line A and B



TECHNO-CONTROL EQUIPMENT

### ACCESSORIES - SPARE PARTS

#### SEALING STRIPS



They protect and safeguard the operators.  
Please note, order double  
the length of the line

**TR8505**

#### INSPECTION JOINT



Generally used in long lines, it favours ease  
of maintenance and current collector  
trolley replacement

**TR8528**

#### COLLECTOR SHOES



35A trolley

**TR8517**

70A trolley

**TR8520**

#### FIXED POINT



**TR8527**

### INSTALLATION ACCESSORIES

#### DE-COIL UNIT



**TR8513**

#### STRIP INSERTION TROLLEY



**TR8514**

# Conductors

## CP series

### Flat cables

#### FLAT CABLES - IN HO7VVH6-F ANTI-AGING PVC

Particularly suitable for supply and control circuits, lifting and handling equipment.

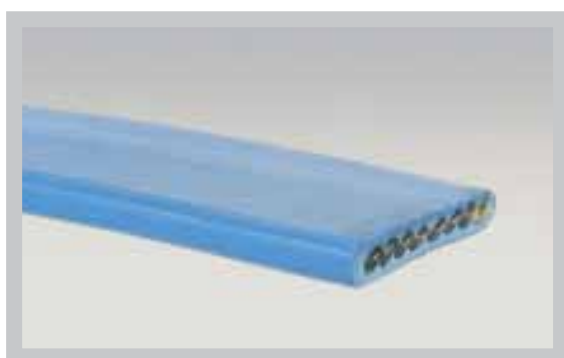

- Comply with CEI 20-22 II (flame resistant)
- Insulation class 2/3
- Operational voltage 450/750V
- Sheathing colour: blue
- Internal flexible conductors with PVC sheathing progressively numbered, plus earth conductor (yellow/green)
- Operating temperature -5 °C +70 °C

REFERENCE No.	CROSS SECTION	APPROXIMATE OUTER DIMENSIONS	STRAND	APPROXIMATE WEIGHT	TOTAL CROSS SECTION	REFERENCE No.	CROSS SECTION	APPROXIMATE OUTER DIMENSIONS	STRAND	APPROXIMATE WEIGHT	TOTAL CROSS SECTION
CP0415AF	4X1,5	15X5,2	30X0,25	150	6	CP2425AF	24X2,5*	54X13	50X0,25	1.100	60
CP0815AF	8X1,5	29X5,5		300	12	CP0404AF	4X4	21X7,5	56X0,30	330	16
CP1215AF	12X1,5	41X5		420	18	CP0804AF	8X4	38X5		550	32
CP1615AF	16X1,5	54X8		510	24	CP0406AF	4X6	24X8	84X0,30	440	24
CP1815AF	18X1,5	43X11		700	27	CP0806AF	8X6	38,5X8		742	48
CP2415AF	24X1,5	51X13		1.000	36	CP0410AF	4X10	35X11	7X12X0,40	800	40
CP0425AF	4X2,5	21X5,7	50X0,25	240	10	CP0416AF	4X16	36,5X12	7X18X0,40	1.200	64
CP0825AF	8X2,5	33X6		420	20	CP04250AF	4X25	43X13	7X28X0,40	1.700	100
CP1225AF	12X2,5	50X7		640	30	CP0435AF	4X35	50X14	7X39X0,40	2.050	140
CP1625AF	16X2,5	41X13		1.000	40						
CP1825AF	18X2,5*	50X13		1.050	45						

Upon request, minimum order 500 m, the same cables can be supplied with:

Heat resistant up to 105° tinned red copper shield.

\* 500 m minimum

# Conductors

## CT series

Round cable with dual strain relief cords



TECHNO-CONTROL EQUIPMENT

### ROUND CABLE WITH STRAIN RELIEF STEEL WIRES - S05VVD7-F

Designed for heavy duty applications in particular for pendant push button stations and moving electromechanical parts.

The two built-in steel wires are on the opposite sides of the PVC sheathing.

When correctly dimensioned and secured to the winch, the strain relief cords avoid stresses to the cable.



- Comply with CEI 20-22 II (flame resistant)
- Insulation class 2/3
- Operational voltage 300/500V
- Sheathing colour: blue
- Internal flexible conductors with PVC sheathing and progressively numbered, plus earth conductor (yellow/green)
- Operating temperature -5°C +70°C
- 2 Ø mm steel wires
- Breaking point: 60 kg/mm<sup>2</sup>

REFERENCE No.	CROSS SECTION	APPROXIMATE WEIGHT CABLE Ø		STRAND	APPROXIMATE WEIGHT	TOTAL CROSS SECTION
CT0815AUAF	8X1,5	11,6	23,6	30X0,25	225	12
CT1215AUAF	12X1,5	14,4	26,4		315	18
CT1615AUAF	16X1,5	16	28		415	24
CT1815AUAF	18X1,5	17	29		470	27
CT2015AUAF	20X1,5	18	30		525	30
CT2415AUAF	24X1,5	21	33		620	36

### ACCESSORIES - FLAT CABLE GLANDS

#### PA CABLE GLAND



12903010

#### PA CABLE GLAND



To be discontinued

REFERENCE No.	THREAD	CABLE ENTRY	CABLE CROSS-SECTION
12903001	1"	19X7	4X1,5
12903002		25X9	4X2,5 - 4X4 - 4X6
12903003	1" 1/4	32X14	4X10
12903004		34X7	8X1,5 - 8X2,5
12903005	1" 1/2	38X8	8X4
12903006		38X12	4X16
12903007	2"	46X16	4X25 - 18/24X1,5 - 16X2,5
12903008		70X8	12X2,5 - 16X1,5 - 4X35
12903009		46X9	12X1,5 - 8X6

**GIOVENZANA**  
**INTERNATIONAL B.V.**  
Notes

A large rectangular area with a yellow border at the top and bottom, and vertical black lines on the left and right sides. The interior is filled with horizontal grey lines, resembling a ruled page for notes.



A large rectangular area for notes, bounded by thin black lines on the left and right sides. The area is filled with horizontal grey lines for writing. A thick yellow horizontal bar is located at the top of this section, and another thick yellow horizontal bar is located at the bottom of this section.





General catalogue  
2006 edition  
Developed and designed by  
GasGas sas  
Via Cortina D'Ampezzo, 12  
20139 Milano  
Printed by  
Mediaprint S.r.l.  
Via Mecenate, 76  
20138 Milano



## **GIOVENZANA INTERNATIONAL B.V.**

WTC - Strawinskylaan 1105, 1077 XW Amsterdam, The Netherlands  
Tel.++31(0) 20.4413576 - Fax ++31(0)20.4413456

Manufacturing Unit 1: G.G.T. S.r.l.- 23889 S. Maria Hoè (LC) Italy - Via M. Mozzanica, 2  
Tel.++39(039)59511.1 - Fax ++39(039)5311.295

Manufacturing Unit 2: G.G.H. K.f.t. - 3036 Gyöngyöstarján - Hungary - Deák F.u 9  
Tel.++36(06)37.572572 - Fax ++36(06)37.572570

**[www.giovenzana.com](http://www.giovenzana.com)**

**e-mail: [giovenzana@giovenzana.com](mailto:giovenzana@giovenzana.com)**