

# HOW TO USE THIS CATALOG

## NAVIGATION



Click your mouse to zoom in or out.  
Click and Drag to scroll.



Click the arrows on the left and right  
of each page to move between them.



Roll your mouse  
over the green  
boxes to watch  
a related video

## PRODUCTS

### Product Description

- product information
- product information

**009-12345**



Click a **Product Number** or **Plus Sign** for  
more information or to purchase the product

## TOOLBAR



Download a PDF of selected pages.



Print selected pages.



Share this catalog.



Use the arrows to move between pages.  
Enter a specific page number in the box  
and press RETURN to jump to that page.



Type a product number, product name,  
or other term into the Search box in the  
upper right to find everywhere it appears.

# Table of Contents

<b>New from Daigger on GSA</b>	A-J
<b>Welcome / Core Values</b>	3
<b>Daigger.com</b>	4-5
<b>A. Daigger and Company</b>	6-7
<b>Daigger Exclusives</b>	8-9
<b>Find Fred &amp; Daigger Webclub</b>	10
<b>Avitro Lab</b>	11



<b>A</b>	<b>Animal Research</b>	12-13
<b>B</b>	<b>Bags</b>	14-19
	<b>Balances</b>	20-57
	<b>Baths &amp; Circulators</b>	58-76
	<b>Beakers</b>	77-80
	<b>Blenders</b>	81-84
	<b>Blood Collection</b>	85-89
	<b>Bottles</b>	90-106
	<b>Brushes</b>	107
	<b>Burets</b>	108-110
	<b>Burners</b>	111



<b>C</b>	<b>Calculators</b>	112
	<b>Carboys</b>	113-115
	<b>Carts</b>	116-120
	<b>Cell Culture</b>	121-142
	<b>Centrifuges</b>	143-174
	<b>Centrifuge Supplies</b>	175-193
	<b>Clamps &amp; Supports</b>	194-196
	<b>Cleaners</b>	197-200
	<b>Clothing</b>	201-205
	<b>Counters</b>	206-208
	<b>Crucibles</b>	209-210
	<b>Cryogenics</b>	211-226
	<b>Cylinders</b>	227-232



<b>D</b>	<b>Dessicators</b>	233-235
	<b>Dialysis</b>	236
	<b>Dishes</b>	237-239
	<b>Dispensers</b>	240-243
	<b>Dissecting</b>	244-247



<b>E</b>	<b>Electrophoresis</b>	248-264
	<b>Environmental Chambers</b>	265-266
<b>F</b>	<b>Film &amp; Foil</b>	267
	<b>Filtration</b>	268-282
	<b>Flasks &amp; Microchemistry</b>	283-291
	<b>Fume Hoods</b>	292-299
	<b>Funnels</b>	300-302
	<b>Furnaces</b>	303
	<b>Furniture</b>	304-310



<b>G</b>	<b>Gloves</b>	311-316
<b>H</b>	<b>Heaters</b>	317-320
	<b>Histology</b>	321-325
	<b>Homogenizers</b>	326-329
	<b>Hot Plates &amp; Stirrers</b>	330-343
	<b>Humidity</b>	344-345

<b>I</b>	<b>Hydrometers &amp; Ice</b>	346-349
	<b>Incubators</b>	350-366
<b>L</b>	<b>Labels &amp; Tapes</b>	367-373
	<b>Lights &amp; Magnifiers</b>	374



<b>M</b>	<b>Mats &amp; Liners</b>	375-378
	<b>Measurement</b>	379
	<b>Media</b>	380-382
	<b>Melting Point</b>	383
	<b>Microscopes</b>	384-397
	<b>Microscope Cameras</b>	398-399
	<b>Microscope Illuminators</b>	400
	<b>Microscope Supplies</b>	401-407
	<b>Mills</b>	408
	<b>Mixers</b>	409-410
	<b>Molecular Biology</b>	411-428
	<b>Mortars and Pestles</b>	429



<b>O</b>	<b>Organizers</b>	430-434
	<b>Ovens</b>	435-442
<b>P</b>	<b>Pens &amp; Notebooks</b>	443-444
	<b>pH</b>	445-469
	<b>Pipettes</b>	470-507
	<b>Pumps</b>	508-515



<b>R</b>	<b>Racks</b>	516-527
	<b>Refractometers</b>	528-530
	<b>Refrigerators</b>	531-545
	<b>Rotary Evaporators</b>	546-547



<b>S</b>	<b>Safety</b>	548-563
	<b>Sample Collection</b>	564-565
	<b>Scoops &amp; Spoons</b>	566
	<b>Shakers</b>	567-590
	<b>Shipping</b>	591-594
	<b>Sieves</b>	595-596
	<b>Spatulas</b>	597-598
	<b>Spectroscopy</b>	599-604
	<b>Stainless Steelware</b>	605
	<b>Sterilizers</b>	606-612
	<b>Stoppers</b>	613
	<b>Syringes</b>	614-617



<b>T</b>	<b>Temperature</b>	618-624
	<b>Timers</b>	625-628
	<b>Trays &amp; Pans</b>	629-630
	<b>Tubes</b>	631-644
	<b>Tubing &amp; Fittings</b>	645-648

<b>U</b>	<b>Ultrasonic Cleaners</b>	649-650
	<b>Ultrasonic Processors</b>	651-652
	<b>UV Lamps</b>	653-655
<b>V</b>	<b>Vials</b>	656-662
<b>W</b>	<b>Washers</b>	663-665
	<b>Water Purification</b>	666-671
	<b>Water Testing</b>	672-682

<b>Index</b>	683-690
<b>Terms &amp; Conditions</b>	Inside Back Cover



# CRAFTSMAN®

POWER AND HAND TOOLS CATALOG 2011-2012



get the tool  
you need  
today!  
**order online**  
**pick-up**  
**in store**

[click here for details](#)



# America's TOOL BRAND\*

# #1

## awards.

over 15 industry awards since 2009



Craftsman leads in all of these categories:  
Hand Tools, Mechanic's Hand Tools, Wrench Sets,  
Garage Door Openers, Screw Drivers, Plier Sets, Tool Storage,  
Tools Chests, Bench Power Tools, General Purpose Hand Tools,  
Air Compressors & Ratchets

Source: TraQline; Dollar Shares; 1Q2011

leading the way with tool

# innovations.

- **Cordless auto-hammer, launched in 2008**
- **Universal tool set, introduced in 2009**
- **Nextec QuickBoost™ Charger, new in summer 2011**

\*Based on TraQline Unit Share and based on those consumers that selected a brand.

†Craftsman was named Power Tool Brand of the Year in the 2011 Harris Poll EquiTrend Study.

Harris Poll® Study, which is based on the opinions of 25,099 U.S. consumers, ages 15 and over surveyed online between January 11 and 27, 2011.

Craftsman received the highest numerical Equity Score among Power Tools included in the 2011 Harris Poll EquiTrend® Study.

Please go to [www.Craftsman.com](http://www.Craftsman.com) for further details.

# fa

- **over 1 billion**
- **introduced**
- **ratchet in**
- **keyless c**
- **Craftsman**
- **of NASCAR**

NASCAR® is a  
National Assoc



# CRAFTSMAN®

## TRUST. IN YOUR HANDS

building  
**trust.**

*into every tool for over 80 years*

- **acknowledged and renowned for decades**
- **lifetime warranty on hand tools\*\***
- **reliable tools that perform consistently**
- **setting the standard for tools since 1927**

\*\*see page 112 for details.

# acts.

*did you know?*

**million handtools sold**  
**ed the quick-release**  
**n 1966 and the first**  
**huck in 1986**

**n is the Official Tools**

**AR®**

registered trademark of the  
Association for Stock Car Auto Racing, Inc.



## Share

*If you see an item or a page in this catalog that you'd like to share with a friend, we've made it easy for you. Simply look for this symbol, touch it with your cursor to see how you can email a page to a friend or share on Facebook and more!*

*the best of*

# CRAFTSMAN<sup>®</sup>

## TRUST. IN YOUR HANDS

*pages 8-31*

### power tools

#### NEXTEC 12V RIGHT-ANGLE IMPACT DRIVER

- *innovative compact design*
- *reduces user fatigue*
- *700 in. lbs. of torque*

*pages 32-41*

### general purpose tools

#### AUTOLOADING MULTI-BIT SCREWDRIVER

- *innovative compact design*
- *reduces user fatigue*
- *includes six magnetic bits*

*pages 42-85*

### mechanic's tools

#### 56-PIECE UNIVERSAL MECHANIC'S TOOL SET

- *works in tight spaces and on multiple fastener types, even partially rounded hex!*

*pages 86-111*

### garage storage

#### 43-INCH CONTOUR POWER STORAGE COMBO





# TOOLS FOR THE...DIY'ER, PROFESSIONAL & MECHANIC

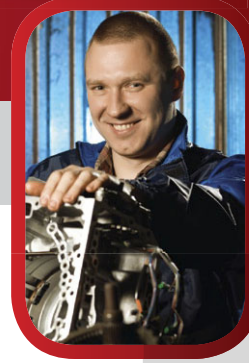
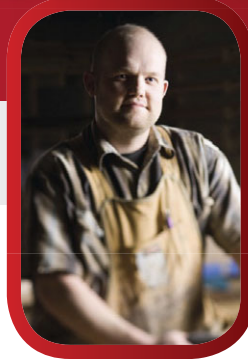

For well over 80 years, Craftsman Tools have earned the trust of every kind of tool user. The home handy man, a knight in shining armor, ready to tackle any project, large or small. His reward is his own pride in a job well done and the grateful thanks of his family. There's the

dedicated home craftsman who takes his tools and his projects seriously. He knows the sense of security that comes from having the right tools for the job and shares a bond with them as they work together to get each job done. The professional and the mechanic each knows his

Craftsman tools will give him years of trouble-free service, will let him finish every job with pride and will satisfy every customer.

## shop your way rewards<sup>®</sup>

join now. earn today. it's free.

## CRAFTSMAN<sup>®</sup> CLUB

**attention members!**  
you don't lose a thing.

You'll receive even greater benefits. Continue to receive special members-only pricing and earn **Shop Your Way Rewards<sup>SM</sup>** points (10 points per \$1 spent) on all Craftsman and other qualifying purchases. More details coming soon on [Craftsman.com](http://Craftsman.com)!

pages 113-144

pages 145-147



**Tool enthusiasts, love tools?**  
If you're a Shop Your Way Rewards member, you love tools and you are not in Craftsman Club<sup>®</sup>, you can join Craftsman Club<sup>®</sup> featuring Shop Your Way Rewards and get all the club benefits. Visit [Craftsman.com](http://Craftsman.com) for details.

enroll today...in store or online!  
[shopyourwayrewards.com](http://shopyourwayrewards.com)

\*Program details on page 112.



# CAN YOUR DRILL DO THIS?

1

delivers 700 inch lbs. of torque power



A

Share

2

transfer and cut exact angles



B

# 4 must have inn

## MORE TOOLS. MORE

SNAP THIS CODE WITH YOUR MOBILE DEVICE AND SEE A VIDEO ON THIS CRAFTSMAN® MITERMAATE SAW



SEE VIDEO at sears.com/shoptools

3

C



CRAFTSMAN®

legs fold for easy storage & transportation

angle finder measures angle



pivot fence adjusts to angle finder for a perfect cut





drives in tight spaces



compact helps reduce user fatigue



### Rob Ostapiuk

"This drill allows me to work in tight spots where my power drill is just too big. The Nextec drill has good power to complete all my drilling tasks."

Learn more about Rob at [sears.com/shoptools](http://sears.com/shoptools)



SNAP THIS CODE WITH YOUR MOBILE DEVICE AND SEE A VIDEO ON THIS CRAFTSMAN® NEXTEC RIGHT ANGLE DRILL



#### Catalog/Online EXCLUSIVE A. Craftsman® Nextec 12V Right-Angle Impact Driver

- Innovative, compact, ergonomic design.
- Reversible drill delivers 700 in. lbs. of torque; 0-2200 rpm.
- 1/4-in. quick-connect clamp, electric brake, and FuelGauge.
- Includes charger, LED work light, battery, 4 accessories and case. Wt. 5 lbs.

009-17562 99.99

Get the Latest Price Online



# tools more cutting edge power tools from Sears

# ovation

## GENIUS. WE MEAN IT. CHECK IT OUT!

#### B. Craftsman 15-amp 10-inch MiterMate™ Saw.

- Angle Transfer System makes accurate crown, chair rail, and base miter cuts.
- Angle Finder measures angles for inside/outside corners.
- Includes horizontal hold-down clamp and dust bag.

009-21226 249.99

Get the Latest Price Online

#### C. Craftsman Portable Benchtop Router Table with Folding Legs

- Table sets up in seconds and quick clamp allows for fast router mounting.
- Starter pin and guard for routing round pieces. Wt. 20 lbs.

009-28140 139.99

Get the Latest Price Online

### CRAFTSMAN®

#### D. new Craftsman® 12-hp, Digital Plunge Base Router with Soft Start Technology

- Permanently sealed 6-speed motor (10,000 – 25,000 rpm) with electronic interface and interactive digital control that lets you choose your material, bit size and type, then automatically sets the correct speed for your project
- Soft Start Technology prevents router take-off as motor slowly increases speed to full capacity.
- Includes: Plunge base, 1/4 & 1/2 collets, sub base, collet and depth adjustment wrenches, edge guide, vac adapter, screws and soft case. Wt. 7.5 lbs

009-27669 129.99

Get the Latest Price Online



takes the guess work out of routing



AVAILABLE JUNE 1, 2011  
PRE-ORDER ONLINE NOW!



**IMPACT WRENCHES ARE "TORQUE TOUGH"**

- Great for tightening and loosening difficult nuts and bolts.
- The utility of a pneumatic impact wrench without the hassle of compressors or hoses.
- Good for automotive use.

# FINALLY...COMPACT

wrenches and drivers with more torque

## A 19.2V IMPACT WRENCH



### A. Craftsman® C3 Impact Wrench Kit

- Delivers 0–3000 rpm, and produces 200 ft.lbs. of torque and 0–3000 ipm.
- Features 1/2-in. anvil with pin retention, mid-handle design with over-mold, and LED light.
- Includes two NiCad batteries, charger, socket extender, auxiliary handle, bag and manual.

Wt. 11.19 lbs.

009-17339

Get the Latest Price Online

169.99

includes storage bag, charger and 2 batteries



B 1 D

### B. Cra Drivers

- Reverse deliver no-load of torque
  - Features and m battery charg
- Wt. 10  
009-17  
Get th

include bag, 2 batt





# AND POWERFUL

... for tough jobs in tight spaces

## 9.2V IMPACT DRIVER



### Craftsman C3 Impact Driver Kit

Reversible impact driver  
 speeds, 1500 in.lbs.  
 torque and 0-3500 imp.  
 res bright LED light  
 mid-handle, two NiCad  
 ies, 2 screwdriver bits,  
 er, bag and manual.  
 0.3 lbs.

7338 149.99  
 Get the Latest Price Online

Includes storage  
 charger and  
 batteries



### IMPACT DRIVERS DELIVER MORE POWER

- Delivers extra power to drive tough screws and bolts.
- No more twisting the chuck-quick and easy bit changes get the job done faster.
- Good for carpentry, plumbing, electrical.

D



## IMPACT BITS CAN TAKE THE HIT! ALWAYS USE THEM WITH YOUR IMPACT DRIVERS



Catalog/Online EXCLUSIVE

### D. Craftsman 29-Piece Heavy-Duty Impact Driver Set

- Heavy-duty for impact drivers; engineered to take a hit and finish the job.
- Forged tip reduces breakage and allows for 2x longer bit life.
- Spring-loaded magnets on all nutsetters eliminate loose magnets. Wt. 1.1 lbs.

009-02662

Get the Latest Price Online

19.99



C



## 12V IMPACT DRIVER

SNAP THIS CODE WITH YOUR MOBILE DEVICE AND SEE A VIDEO ON THIS CRAFTSMAN® NEXTEC RIGHT ANGLE DRILL



for tough jobs where other drills can't go



### C. Craftsman Nextec 12V Right-Angle Impact Driver

- Innovative, compact, ergonomic design.
- Reversible drill delivers 700 in.lbs. of torque; 0-2100 rpm.
- 1/4-in. quick-connect clamp, electric brake, and FuelGauge.
- Includes charger, LED work light, battery, 4 accessories and case. Wt. 5 lbs.

009-17562

Get the Latest Price Online

99.99



E



### E. Craftsman Nextec 12-volt Lithium-Ion Impact Driver.

- Compact design with soft grip, 1/4-inch collet, and LED light.
- Delivers 830 in./lbs. torque, 0-3000 bpm, and 0-2200 rpm. Wt. 5 lbs.

009-17428

Get the Latest Price Online

109.99

portable power





### A. Craftsman® Evolv™ 18V Reversible Drill/Driver

- Variable speed (0–650 rpm) motor allows lower speeds for starting holes.
- 24-position clutch adjusts to permit the bit to slip at various torque settings.
- Includes 18V battery, 3-hour charger and two double-end bits. Wt. 7.01 lbs.

009-11383 49.99  
[Get the Latest Price Online](#)



KITCHEN  
REMODELING



FURNITURE  
ASSEMBLY



### B. Craftsman C3 19.2V Cordless Drill/Driver

- Variable speed, with versatility to drill at low and high speeds.
- Forward/reverse function; 24 torque settings.
- Keyless chuck; electric brake. Wt. 6.1 lbs.

009-17191 79.99  
[Get the Latest Price Online](#)



# D.I.Y. PROJECTS HAVE Tools that cut it, drill it & g

### CRAFTSMAN NEXTEC DRILL/ DRIVER

#### E. Craftsman Nextec 12V Lithium-Ion Drill/Driver

- Compact design with soft grip, 3/8-in. chuck and LED light.
- Delivers 195 in.lbs. of torque and 0–400/0–1300 rpm. Wt. 4 lbs.

009-17586 69.99  
[Get the Latest Price Online](#)



#### F. new Craftsman Evolv™ 4.5-amp Jig Saw.

- 800–3000 spm motor, two-finger trigger switch, dial for precise speed control
- lock-on switch, 0–45 degree left to right adjustable base and 3-position orbital action lever
- Includes saw, vacuum connection, two blades, key, edge guide and manual. Wt. 3.1 lbs.

009-17434 29.99  
[Get the Latest Price Online](#)



#### G. Craftsman Variable Speed Rotary Tool Kit.

- Delivers precision and control to complete a wide range of projects.
- Perfect for sanding, grinding, cutting, sharpening and drilling.
- Features a soft-grip body for comfort and control, replaceable motor brush for extended tool life, multipurpose cutting guide attachment, flex light attachment and 35 accessories.
- Includes bit box and storage case. Wt. 3.37 lbs.

009-61139 69.99  
[Get the Latest Price Online](#)



### L. Craftsman 1/2-Inch Corded Hammer Drill

- 6-amp motor for power in either rotary or rotary hammer modes.
- Variable speed; trigger switch with lock-on.
- 1/2-in. keyless chuck; drill/hammer capable; overmold grip. Wt. 10.6 lbs.

009-10137 69.99  
[Get the Latest Price Online](#)



### M. Craftsman Professional® 8-amp Corded 1/2-Inch Hammer Drill

- Variable speed rotary drilling of 0–2800 rpm; manual spindle lock.
- 1/2-in. keyed steel chuck allows quick tightening of bits.
- Forward/reverse. Wt. 11.25 lbs.

009-28129 119.99  
[Get the Latest Price Online](#)



### N. Craftsman C3 19.2V Cordless 1/2-Inch Hammer Drill/Driver

- Dual speed ranges; 24-position torque clutch.
- Mid-handle design with overmold comfort grip.
- 360-degree auxiliary handle; electric brake; bit storage.

009-11543 149.99  
[Get the Latest Price Online](#)







SEE VIDEO  
at sears.com/shoptools

HOME  
ADDITIONS



SEE VIDEO  
at sears.com/shoptools

BATHROOM  
REPAIR

**CRAFTSMAN**

**C. Craftsman 13-amp Cored 7 1/4-Inch Circular Saw**

- Ball bearing motor provides 5000 rpm.
- Cast aluminum upper/lower blade guards.
- 24-tooth carbide blade, built-in dual bulb LED light and on-board tool storage. Wt. 17.32 lbs.

009-10871 69.99

Get the Latest Price Online

**CRAFTSMAN**

**PROFESSIONAL**

**D. Craftsman Professional 12-amp 360° Scrolling Reciprocating Saw**

- Features tool-less blade change, 3-position mode selector, 0-2700 spm variable speed, and no-stop, free rotating head.
- Includes soft case, live tool indicator and wood blade. Wt. 8.9 lbs.

009-27224 99.99

Get the Latest Price Online

# WE MET THEIR MATCH

grind it...with precision



**CRAFTSMAN**  
**evolv**

**H. Craftsman Evolv™ 12-amp Circular Saw**

- 7 1/4-in. circular saw with 5500-rpm motor.
- Ergonomic handles for comfort; lightweight and durable die-cast aluminum blade guards.
- Bevel capacity of 0-45 degrees; steel shoe features an integrated cross-cut ruler for reference and measurement. Wt. 15.81 lbs.

009-18780

39.99

Get the Latest Price Online



**CRAFTSMAN**

**J. Craftsman 4-amp One-Handed Reciprocating Saw**

- One-handed design goes where other reciprocating saws can't go.
- 0-3500 variable spm for precise speed control.
- Ergonomic for comfort; tool-less blade change. Wt. 4 lbs.

009-17291

79.99

Get the Latest Price Online



**K. Craftsman® 2-amp Corded Multi-Tool**

- Sands, cuts, grouts, and scrapes.
- Variable-speed 2.0-amp motor; soft-grip design.
- Integrated LED work light. Wt. 2.55 lbs.

009-23465

79.99

Get the Latest Price Online



**CRAFTSMAN**

**P. Craftsman 54-Piece Driving Set**

- 1/4-in. Speed-Lok® quick connector.
- 33 assorted 1-in. insert bits, 9 power bits (2-in.), 3 power bits (3-in.) and 7 assorted nut setters.
- Magnetic bit holders and molded case. Wt. 1.6 lbs.

009-26393

24.99

Get the Latest Price Online



**CRAFTSMAN**

**Q. Craftsman 7 1/4-Inch Steel Saw Blade Variety 5-Pack**

- Two chisel teeth steel blades (7 1/4 in. x 20 tooth).
- One plywood smooth cut steel blade (7 1/4 in. x 150 tooth).
- Two cutoff/rip steel blades (7 1/4 in. x 40 tooth). Wt. 3.15 lbs.

009-32302

19.99

Get the Latest Price Online



**CRAFTSMAN**

**PROFESSIONAL**

**R. Craftsman Professional Bi-Metal Reciprocating Saw Blade Set, Multi-Purpose 10-Pack**

- Five 6-in. blades for wood/nail, metal and multi-purpose.
- Four 9-in. wood/nail, multi-purpose.
- One 8-in. metal cutting, plus bonus storage pouch. Wt. 1 lb.

009-64500

32.99

Get the Latest Price Online

\*Warranted, see page 112.

portable power





A

**CRAFTSMAN** **12V 4-PIECE COMBO**  
**NEXTEC**

**A. SAVE \$33 Craftsman® Nextec 12V Lithium-Ion 4-Piece Combo Kit**  
 • Includes True Finish sander, 3 3/8-in. circular saw, drill/driver and work light.  
 • Tools feature integrated LED lights and fuel gauges.  
 • Includes 2 batteries and case. Separate prices total \$202.99. Wt. 14 lbs.  
 009-17588 **169.99**  
**Get the Latest Price Online**



includes battery & storage bag

Catalog/Online EXCLUSIVE  
**B. SAVE \$30.96 Craftsman® Nextec 12V Lithium-Ion 4-Piece Combo Kit**  
 • Includes a Hammerhead, Multi-tool, Drill Driver and LED work light.  
 • All tools are ultra-compact and ergonomically designed to get into tight spaces.  
 • 30-minute quick charger for 2 batteries; includes storage case. Separate prices total \$250.95. Wt. 10 lbs.  
 009-25775 **219.99**  
**Get the Latest Price Online**

**CRAFTSMAN**  
**NEXTEC**  
**12V 4-PIECE COMBO**



B

**SAVE ON GREAT COMBOS**



D



**D. Craftsman® Nextec 12-volt Lithium-Ion Battery**  
 • Ultra-compact, lightweight DieHard® battery.  
 • Improved performance and shelf-life over NiCd batteries.  
 • 30-minute charge time. Wt. 0.5 lb.  
 009-11221  
**Get the Latest Price Online**



E

24.99

**E. Craftsman® Nextec Circular Saw**  
 • 2400 RPM motor to cut, rip or plunge through laminates, soft or hard woods.  
 • Upper blade guard for quick 1-1/4-in. hose connection. Lower guard designed to reduce snags when cutting.  
 • Easy-read quick release depth contro.  
 • Includes LED work light, 3-3/8-in 20-tooth carbide tipped blade and electric brake to stop blade when trigger is released. Wt. 3.2 lbs.  
 009-61325 **59.99\***  
**Get the Latest Price Online**



F

**F. Craftsman® Nextec Multi-Saw**  
 • Unique saw functions as both a sabre saw and reciprocating saw.  
 • Ergonomic design for comfort and ease of use.  
 • Convenient Nextec interchangeable battery platform. Wt. 3.7 lbs.  
 009-14299 **49.99\***  
**Get the Latest Price Online**





## John Nanney

"The quick charge battery and the weight of these tools allows me to work all day without tiring.

This set is amazing."

Learn more about John at [sears.com/shoptools](http://sears.com/shoptools)

Catalog/Online EXCLUSIVE

### C. SAVE \$100.93 Craftsman Nextec 12V Lithium-Ion 6-Tool, 10-Piece Combo Kit with Storage

- Compact, ergonomic tools powered by DieHard® battery.
- Includes True Finish sander, 3 3/8-in. circular saw, drill/driver, multi-tool, hammerhead, LED work light, 2 batteries, 30-minute charger and case.

Separate prices total \$400.92. Wt. 28 lbs.

009-25779 299.99

[Get the Latest Price Online](#)

## 12V 10-PIECE COMBO



includes rolling storage case

portable power

# ONE BATTERY FITS ALL



G  
+

### G. Craftsman® Nextec LED Worklight

- Luminous 24-bulb LED worklight with rotating head and ergonomic design
- Convenient Nextec interchangeable battery platform. Wt. 1.46 lbs.

009-14298

[Get the Latest Price Online](#)

15.99\*



H  
+

### H. Craftsman® Nextec Hammerhead™ Auto Hammer

- Drives nails where hammers cant!
- Patented hammering action delivers 3600 strikes per minute to drive finish or common nails flush up to 3-1/2 long.
- Ergonomic design and Nextec battery platform. Wt. 1.5 lbs.

009-61352

[Get the Latest Price Online](#)

59.99\*



J  
+

### J. Craftsman® Nextec Multi-Tool

- Versatile tool is ideal for cutting, scraping, sanding, grinding, removing grout and more.
- With a compact, ergonomic design, multiple blade positions and the Nextec battery platform.

Wt. 1.4 lbs

009-61199

[Get the Latest Price Online](#)

59.99\*

\*Batteries not included.



**A. Craftsman® C3 Jigsaw with Laser**  
 • 4 orbital cutting positions for aggressive cutting.  
 • LaserTrac® system for accurate blade alignment.  
 Wt. 5 lbs.  
 009-11569 **59.99\***  
 Get the Latest Price Online

**CUT**



A



**B. Craftsman C3 Hand Vac**  
 • Bagless operation; quick-change filter.  
 • Crevice tool and brush attachment. Wt. 2.64 lbs.  
 009-11571 **24.99\***  
 Get the Latest Price Online



B



**VACUUM**



# 30 TOOLS, HUNDREDS

**CRAFTSMAN®—THE MOST PREFERRED POWER**

**19.2V 5-PIECE COMBO**



D



**D. SAVE \$72 Craftsman® C3 19.2V 5-Piece Combo Kit**  
 • 1/2-in. drill/driver with 2-speed gear box for 0-400/0-1400 rpm; 24-position clutch and keyless chuck.  
 • 5 1/2-in. trim saw delivers 4500 rpm with carbide blade.  
 • Reciprocating saw delivers 0-3100 spm with a 7/8-in. blade stroke.  
 • Impact driver with 1/4-in. hex collet delivers 0-2500 rpm and 0-3000 bpm.  
 • Comes with fluorescent worklight.  
 • Includes 2 DieHard® Ni-Cad batteries and 1-hour charger. Separate prices total \$331.99. Wt. 30 lbs.  
 009-11445 **259.99**  
 Get the Latest Price Online



E

**19.2V 2-PIECE COMBO**

**E. SAVE \$44.98 Craftsman C3 19.2V NiCad Combo Kit with Right Angle Drill**  
 • Includes 1/2-in. drill/driver; plus right angle drill works where others cannot.  
 • Four double-ended drill bits; two NiCad batteries; charger; case. Separate prices total \$184.97. Wt. 18.7 lbs.  
 009-11548 **139.99**  
 Get the Latest Price Online



includes battery & storage bag

\*Batteries not included.

**START WITH A COMBO,**



See page 17 (R) for details.

# INFLATE

Share



C

# SAND

+



C. Craftsman C3 Pad Sander  
• 11,000 opm for fast material removal.  
• Triangle pad design for tight spaces.  
Wt. 2.5 lbs.  
009-11570 32.99\*  
Get the Latest Price Online



portable power

# OF SOLUTIONS

## TOOL BRAND BY DIY-ERS... AND ONLY AT SEARS.

### 1 BATTERY TOTAL TOOL SOLUTION

#### F. SAVE \$39.98 Craftsman C3 19.2V Cordless Drill/Driver and Impact Combo

- 3/8-in. drill/driver with 3/8-in. keyless chuck.
  - 1/4-in. impact driver with 1/4-in. hex coupler.
  - Variable speed with 2 batteries and charger.
- Separate prices total \$189.97.  
Wt. 13.1 lbs.

009-11550 149.99  
Get the Latest Price Online

#### G. SAVE \$67 Craftsman C3 19.2V 4-Piece Combo Kit

- Includes drill/driver, trim saw, reciprocating saw and fluorescent worklight.
- 1/2-in. drill/driver has 1/2-in. keyless chuck.
- Trim saw has 5 1/2-in. carbide blade.
- Reciprocating saw with 7/8-in. blade stroke.
- Fully assembled. Separate prices total \$256.99.

009-11404 189.99  
Get the Latest Price Online



19.2V  
2-PIECE  
COMBO



19.2V  
4-PIECE  
COMBO

## ADD MORE TOOLS, COLLECT THEM ALL. TURN AHEAD



**A. Craftsman® C3 7 1/4-Inch Circular Saw**

- Integrated dual lasers.
- Operates at 3600 rpm. Wt. 11 lbs. • 009-11585 109.99\*

[Get the Latest Price Online](#)

**B. Craftsman C3 Right Angle Drill**

- 0–1050 rpm; reversible.
- 150 in.lbs. of torque.
- LED light. Wt. 3.28 lbs. 009-11576 69.99\*

[Get the Latest Price Online](#)

**C. Craftsman C3 Impact Driver**

- Ideal for heavy driving.
- 1500 in.lbs. of torque and 0–3500 ipm. Wt. 3 lbs. 009-17080 74.99\*

[Get the Latest Price Online](#)

**D. Craftsman C3 19.2V Compact Lithium-Ion Cordless Drill/Driver**

- Robust motor with 340 in.lbs. of torque.
- Includes battery, charger and 2 screwdriver bits. Wt. 6.1 lbs. 009-17310 119.99\*

[Get the Latest Price Online](#)

**E. Craftsman C3 19.2V Reciprocating Saw**

- Variable speed; 0–3100 spm.
- Quick and easy blade changes. Wt. 4.1 lbs. 009-17549 59.99\*

[Get the Latest Price Online](#)



**Power Choice**



**19.2V LITHIUM-ION**

**H. Craftsman C3 19.2V Lithium-Ion Battery**  
 • For when you need a spare. Wt. 1.76 lbs. 009-11374 89.99\*  
[Get the Latest Price Online](#)

- holds charges for nearly 18 months
- lightweight, reduces fatigue
- 40% longer shelf life than NiCad



**PUSH-BUTTON POWER GAUGE INDICATES CHARGE LEVEL**

**THE C3 BATTERY**  
 Two technologies, pick the one



**J. Craftsman C3 LED Light**

- High-intensity LED.
  - Rotating head.
  - Convenient hanging hook. Wt. 0.71 lb. 009-17601 24.99\*
- [Get the Latest Price Online](#)



**K. Craftsman C3 Wet/Dry Vac**

- 2-gallon capacity.
  - 100 mph blower.
  - Includes tools and holder. Wt. 9 lbs. 009-17598 49.99\*
- [Get the Latest Price Online](#)



**N. Craftsman C3 4-Port Multi Charger**

- Safely charges all 19.2 NiCd/Lithium batteries.
  - Fast, 1-hour or less charging. Wt. 5.76 lbs. 009-17311 79.99\*
- [Get the Latest Price Online](#)

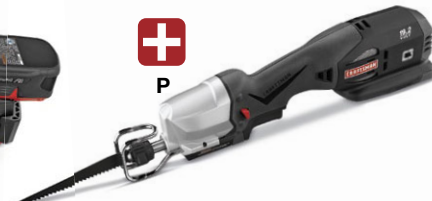

**P. Craftsman C3 Reciprocating Saw**

- One-hand Ergo Grip.
  - Tool-free blade changes.
  - Smooth 0–3500 spm. Wt. 4.5 lbs. 009-17600 89.99\*
- [Get the Latest Price Online](#)





**CRAFTSMAN®**

**C3™**

**1 BATTERY  
TOTAL TOOL SOLUTION**



**F. Craftsman C3 Hammer Drill/Driver**

- Variable speed; reversible.
- Heavy-duty planetary gear box. Wt. 10.24 lbs.

009-11580 74.99\*

**Get the Latest Price Online**

**G. Craftsman C3 Impact Wrench**

- 200 ft.lbs. of torque and 0-3000 ipm. Wt. 4.5 lbs.

009-17090 99.99\*

**Get the Latest Price Online**

portable power

THAT POWERS THEM ALL  
the battery power solution that works for you



**L**  
+



**L. Craftsman C3 Worklight**

- Freestanding for hands-free use.
- 180° pivoting head. Wt. 0.98 lb.

009-11391 14.99\*

**Get the Latest Price Online**

**M**

+



**M. Craftsman C3 Fluorescent Worklight**

- Folding hanging hook provides hands-free use. Wt. 1.5 lbs.

009-11407 16.99\*

**Get the Latest Price Online**

**Q**

+



**Q. Craftsman C3 AM/FM Weather Radio**

- 7 weather-band frequencies.
- MP3 cable; digital display. Wt. 2.6 lbs.

009-10126 29.99\*

**Get the Latest Price Online**

+

**R**



**R. Craftsman C3 Cordless Inflator**

- Auto shut-off; backlit digital readout.
- 200 psi max.; 3 nozzles. Wt. 3.5 lbs.

009-11586 44.99\*

**Get the Latest Price Online**

**Power Choice 2**  
**19.2V NiCad**

- holds full power capacity right to the end of charge
- low cost

**S. Craftsman C3 NiCad Battery**

- For all C3 tools.
- 19.2DieHard® battery. Wt. 2.44 lbs.

009-11375 34.99\*

**Get the Latest Price Online**

**S**

+



**POWER FOR ALL YOUR JOBS**

**19.2 VOLT DieHard®**

C3 TOOLS ONLINE

\*Batteries not included.  
• See page 112 for laser use and precautions.



# CRAFTSMAN®

## AVAILABLE JUNE 1, 2011 PRE-ORDER ONLINE NOW!

### SOFT START TECHNOLOGY HELPS PREVENT ROUTER TAKE-OFFS

#### A. new Craftsman® 14-amp, 2.5-hp Fixed/Plunge Base Router with Soft Start Technology

- Permanently sealed motor with 9 variable speeds—10,000 to 25,000 rpm and electronic feedback control to ensure proper rpm for various bit sizes.
- Dual full-view window and front/rear chip deflectors.
- Includes 1/2 and 1/4-in. collets, 2 router bases, edge guide, dust extraction hoods, wrench and case. Wt. 15.5 lbs.

009-27680 **169.99**  
[Get the Latest Price Online](#)



#### B. new Craftsman 12-amp, 2-hp Fixed Base Router with Soft Start Technology

- Permanently sealed motor with 6 variable speeds—10,000 to 25,000 rpm and electronic feedback control to ensure proper rpm for various bit sizes.
- Dual full-view window and front/rear chip deflectors.
- Includes 1/2 and 1/4-in. collets, edge guide, wrench and case. Wt. 11 lbs.

009-02768 **89.99**  
[Get the Latest Price Online](#)

#### C. new Craftsman 12-amp, 2-hp Fixed/Plunge Base Router with Soft Start Technology

- Permanently sealed motor with 6 variable speeds—10,000 to 25,000 rpm and electronic feedback control to ensure proper rpm for various bit sizes.
- Dual full-view window and front/rear chip deflectors.
- Includes 1/2 and 1/4-in. collets, 2 router bases, edge guide, 2 vac adapters, wrench and case. Wt. 13 lbs.

009-27683 **119.99**  
[Get the Latest Price Online](#)



#### D. Craftsman Professional® HPP Router Table

- Benchtop style with 486 sq. in. durable aluminum top, molded ABS plastic legs and bit storage panel.
- Also features rigid aluminum router mounting plate. Wt. 34.8 lbs.

009-61181 **199.99**  
[Get the Latest Price Online](#)



#### E. Craftsman Fixed-Base Router/Table Combo

- 9.5-amp, 1 3/4-hp motor delivers 25,000 rpm and features soft-start technology and live tool indicator.
- 334 sq. in. table offers smooth laminate worksurface, above-the-table height adjustment, extended adjustable fence and 2 1/2-in. dust port. Wt. 26.5 lbs.

009-28180 **139.99**  
[Get the Latest Price Online](#)  
Craftsman Router Table  
009-28160 Wt. 17.6 lbs. **69.99**  
[Get the Latest Price Online](#)

# THE SUBTLE DIFFERENCE

Get the right



#### F. Craftsman 30-Piece Router Bit Set in Wooden Case

- Complete set of 30 popular router bits with solid carbide tips.
- Anti-kickback bit design; clear-door wooden case.
- Solid carbide tips for long-lasting durability. Wt. 5.5 lbs.

009-26366 **109.99**  
[Get the Latest Price Online](#)



#### G. Craftsman 10-Piece Router Bit Set

- Includes 1-in. 45° chamfering, 1/2-in. cove, 3/8-in. beading, 5/8-in. v-groove, 1-in. corner rounding, 3/4-in. straight, 1/2-in. straight, 1/4-in. roman ogee, 3/8-in. core box and 1/2-in. dovetail. Wt. 2.07 lbs.

009-26002 **69.99**  
[Get the Latest Price Online](#)  
8-Piece Router Bit Set  
009-26005 Wt. 1.54 lbs. **49.99**  
[Get the Latest Price Online](#)  
6-Piece Router Bit Set  
009-26004 Wt. 1.1 lbs. **39.99**  
[Get the Latest Price Online](#)

# CRAFTSMAN®

PROFESSIONAL



Share



**CRAFTSMAN**  
PROFESSIONAL

H. Craftsman Professional 2.7-amp 5-inch Vibrafree® Random Orbit Sander with Cyclonic Dust/Air Separator.

- Delivers 12,000 opm.
- Counter balance system reduces vibration.
- Includes dust tube adapter, sandpaper, and case.

Wt. 8.6 lbs.  
009-25927

99.99



**CRAFTSMAN**

J. new Craftsman Sandpaper Portfolio.

- Includes: 50 assorted sheets coarse, medium, and fine grit.
- Divided case.

Wt. 3.25 lbs.  
009-22893

19.99



+

K. Craftsman Professional 3-amp Corded 5-inch Random Orbit Sander.

- Variable-speed motor delivers 5000 to 12,000 opm.
- Removable dust bag, vacuum adapter, sealed switch. Wt. 4.9 lbs.

009-27675

59.99

**CRAFTSMAN**  
PROFESSIONAL

portable power

# REFERENCE IS IN THE FINISHING TOUCH

touch with Craftsman® routers and sanders



+

L. Craftsman Low Profile 3 x 21-Inch Sander

- 3-position adjustable handle adapts to a range of projects.
- Retractable locking hood exposes top of sanding belt for use in a variety of applications.
- 6-amp variable speed motor; 3 x 21-in. standard belt.
- 400-800 rpm. Wt. 8.25 lbs.

009-11722 79.99  
Get the Latest Price Online



+

M. Craftsman 5-Inch Variable Speed Random Orbit Sander

- 2.8-amp motor; counterbalanced design eliminates vibration.
- Duplicates hand sanding motion; provides a swirl-free finish.
- 7,000-12,000 rpm. Wt. 3.5 lbs.

009-11218 49.99

Get the Latest Price Online

5-Inch Dustless Random Orbit Sander

009-11217 Wt. 4 lbs. 39.99

Get the Latest Price Online



includes case and accessories



+

N. Craftsman 10-Inch Buffer/Polisher with 5-Gallon Bucket

- 2800 random orbits per minute, matched to precision-tuned counterweight system, simulates hand-polishing motion for a swirl-free shine.

• Includes 3 terry cloths, 3 applicators, polishing bonnet, hand application pad and 5-gallon bucket with wrap. Wt. 8 lbs.  
009-10723 54.99

Get the Latest Price Online



+

+

P. Craftsman 7-Inch Buffer/Polisher

- With 3800 random orbits per minute matched to precision-tuned counterweight system for reduced vibration.

• Simulates hand polishing motion for swirl-free results.

• Includes terrycloth and wax applicator bonnets. Wt. 5 lbs.  
009-10721 39.99

Get the Latest Price Online

latest price online

\* Warranted, see page 112.

Get the Latest Price. sears.com/shoptools





## John Nanney

"This set is a great price for all the bits I need-especially the counter-sink bits which I use when installing my floors."

Learn more about John at [sears.com/shoptools](http://sears.com/shoptools)



B



### B. Craftsman 30-Piece Drilling/Driving Bit Set

- Includes (15) 1-in. insert bits: Phillips (2) P1, (5) P2, (2) P3, Slotted (1) 6-8, (2) 8-1, Square Recess SQ1, SQ2, SQ3; and 2-in. power bits: Phillips (3) P2, Square Recess (2) SQ2.
- 9 black oxide drill bits 1/4, 7/32, 3/16, 1/8, 3/32, 5/64 and (2) 1/16-in.; bit holder and case. Wt. 0.9 lb.

009-64420

19.99

Get the Latest Price Online



C



### C. Craftsman 83-Piece Insert Bit Set

- Includes 1- and 2-in. Phillips, square, Pozi, slotted and Torx® insert bits and nut drivers.
- Ideal for most household projects. Wt. 1.5 lbs.

009-26535

32.99

Get the Latest Price Online



D



### D. Craftsman 10-piece Screw Extractor Set.

- Includes heat-treated tempered tool steel screw extractors #1 thru #5.
- Each tapered and with left-hand spiral flutes to grip screws firmly and five matching HSS pilot bits. Wt. 0.5 lb.

009-66196

17.99

Get the Latest Price Online



DRIVE IT



DRILL IT

**SPEED-LOK™  
CONNECTOR FOR  
ONE-HANDED BIT  
CHANGES**

**CRAFTSMAN®**

Catalog/Online EXCLUSIVE

### A. Craftsman® 155-Piece Ultimate Speed-Lok™ Set

- 21 1/4-in. hex shank titanium-coated bits, Speed-Lok cow, and ratcheting screwdriver handle.
- Includes Speed-Lok flex shaft with seven 3-in. power bits, 27 2-in. power bits, 73 1-in. insert bits and accessory bag. Wt. 7.05 lbs.

009-89643

149.99

Get the Latest Price Online

### E. Craftsman 29 1/4-Inch Folding Universal Tool Stand

- Folds and stores with ease, yet holds up to 300 lbs.
- Integrated 3-way locking system secures both frames together.
- Provides a steady workspace. Wt. 25 lbs.

009-19730

99.99

Get the Latest Price Online



E



### F. Craftsman Professional® Adjustable Work Stand

- Adjusts from 28 to 36 in. high with a work surface of 638 sq. in.
- Compact design quickly folds up and locks; heavy-duty steel "X" frame supports up to 400 lbs.
- Safety switch and circuit breaker reset. Imported. Warranted.\* Wt. 52 lbs.

009-22335

159.99

Get the Latest Price Online

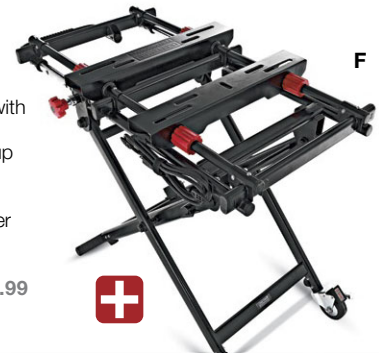

F





**ALWAYS USE  
IMPACT BITS  
WITH IMPACT  
DRIVERS**



**G. Craftsman 11-Piece Heavy-Duty Impact Driver Bit Set**  
 • Heavy-duty for impact drivers; engineered to take a hit and finish the job. Wt. 0.3 lb.  
 009-02663 **9.99**  
[Get the Latest Price Online](#)



**H. Craftsman 13-Piece Spade Bit Set**  
 • 1/4-in. thru 1-in. wood boring spade bits.  
 • Includes metal storage rack. Wt. 1 lb.  
 009-20919 **19.99**  
[Get the Latest Price Online](#)



**J. Craftsman 22-Piece Drill/Driver Bit Set**  
 • Includes six 1/4-in. zinc drill bits (1/16–3/16 in.), seven ea. 1- and 2-in. driver bits, bit holder and Speed Lok™ 1/4-in. quick connector.  
 • All in modular case. Wt. 1.6 lbs.  
 009-64074 **24.99**  
[Get the Latest Price Online](#)

**CRAFTSMAN® (CM) & CRAFTSMAN PROFESSIONAL® (CP) DRILL BITS**

- Featuring Exclusive Point® Geometry for fast drilling.
- Split Point with groove drills on contact and helps eliminate “walking.”
- Available in different materials for your unique application needs.

**BLACK OXIDE FOR**  
 • PLASTIC  
 • WOOD  
 • SOFT METAL

**TITANIUM FOR**  
 • INDUSTRIAL  
 • SOFT METAL  
 • THRU HEAT-TREATED STEEL

**COBALT FOR**  
 • STAINLESS STEEL  
 • HEAT-TREATED STEEL

CRAFTSMAN® AND CRAFTSMAN PROFESSIONAL® DRILL BITS								
	Catalog Number	Qty.	CM/CP	Material	Size Range	Weight, lbs.	Case	Price
K	009-64082	21	CM	Black Oxide	1/16–3/8-in.	1.23	Plastic	\$29.99
	009-64083	29	CM	Black Oxide	1/16–1/2-in.**	3.00	Metal	69.99
L	009-64072	21	CM	Titanium	1/16–3/8-in.	1.25	Plastic	39.99
M	009-64085	21	CP	Cobalt	1/16–3/8-in.	1.25	Plastic	59.99
	009-64086	29	CP	Cobalt	1/16–1/2-in.**	3.00	Metal	99.99

\*\*25/61-1/2 with reduced 3/8 shank

[Get the Latest Price Online](#)

**N. Craftsman Universal Miter Saw Stand**

• Ideal for larger projects, this sturdy miter saw stand adjusts up to 10 feet.  
 • Two 6-in. wheels, 4 adjustable work supports, 2 Teflon® coated stationary supports and 2 roller supports.  
 • Extension arms adjust up to 10 ft., holds up to 500 lbs. Wt. 57.5 lbs.  
 009-22304 **129.99**  
[Get the Latest Price Online](#)



**P. Craftsman Heavy-Duty Foldable/Portable Triple Roller Support Stand**

• 280 sq. in. surface supports up to 330 lbs.  
 • Quick-release button folds the stand down for easy storage.  
 • 27 1/2 to 43 1/2-in. height adjustment. Imported. Wt. 34.2 lbs.  
 009-22268 **69.99**  
[Get the Latest Price Online](#)



**accessories**





A

AMERICA'S BEST  
DUST COLLECTION  
SYSTEM\*



12-INCH  
DUAL  
BEVEL

**CRAFTSMAN**  
PROFESSIONAL

**A. Craftsman Professional® 12-Inch 15-amp Dual-Bevel Compound Miter Saw with Laser Trac® System**

- Laser Trac® cutting guide makes set-up fast and easy.
- Dual bevel capability for ease of bevel cutting.
- 40-tooth carbide-tipped blade and quick-release clamp. Wt. 49.5 lbs. \*

009-21235

[Get the Latest Price Online](#)

349.99



D



**D. Craftsman Professional Universal Bench Tool Work Stand.**

Provides 592 sq. in. work surface and a capacity of 300 lbs. Dual, height-adjust, ball bearing roller extensions support pieces up to 8 feet in length. Features steel legs with cross supports, two rear 10-inch wheels and two smaller front wheels, flexible-neck worklight, keyed safety switch, cord and cord wrap. Imported. Warranted\*. Wt. 86 lbs.

009-22338

219.99

**B. Craftsman® 10-Inch 15-amp Compound Miter Saw with Laser Trac® System**

- Laser Trac® System puts a laser-accurate line on a work piece for more precise miter, bevel, cross, and compound cuts.
- 4800-rpm ball-bearing motor; die-cast aluminum body.
- 40-tooth carbide-tipped blade; dust collection bag. Wt. 28.5 lbs. \*

009-21236

[Get the Latest Price Online](#)

129.99

B 10-INCH

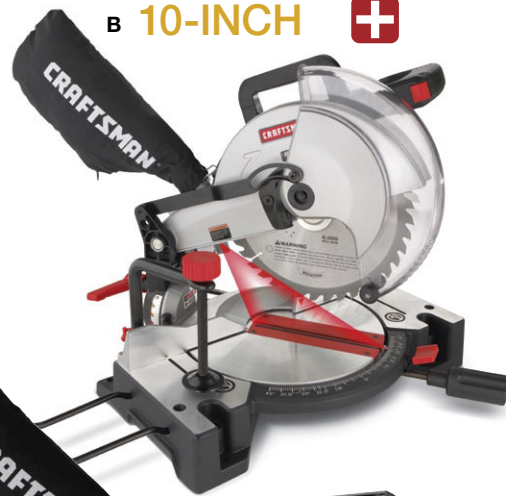

C



7 1/4-INCH

**C. Craftsman 7 1/4-Inch 9-amp Miter Saw with Laser Trac® System**

- Ideal for framers, hobbyists, craft and molding work, and many other carpentry jobs; portable design with Laser Trac® System for accuracy and speed.

- Large quick-release knobs. Wt. 16 lbs. \*

009-21180

[Get the Latest Price Online](#)

89.99

MAKE QUICK  
WORK OF  
PRECISION CUTS

Craftsman® miter saws,  
designed for both  
speed & accuracy

- EXTENDS TO SUPPORT UP TO 16-FT. WORKPIECE
- HOLDS UP TO TWO BENCH POWER TOOLS
- ADJUSTABLE WORKLIGHT





# SLIDING COMPOUND MITER SAWS WITH LASER TRAC® SYSTEM

bench power



**E**  
7 1/4-INCH

**E. Craftsman 7 1/4-Inch Sliding Compound Miter Saw with Laser Trac® System**

- Ideal for miter, bevel, and compound angle cuts.
- Features a dual slide rail system that allows for up to 8-in. crosscut widths.
- AC-powered Laser Trac® System generates accurate line guide for precise cuts; 40-tooth carbide-tipped saw blade stays sharp.
- Features dust bag, hold-down safety clamp, built-in positive miter and bevel angles, and 5000-rpm ball-bearing motor. Wt. 28.69 lbs. \*

009-21194

169.99

[Get the Latest Price Online](#)



**F**  
12-INCH

**F. Craftsman 12-Inch 15-amp Sliding Compound Miter Saw with Laser Trac® System**

- 15-amp motor with electric brake, dual sliding rail system that cuts up to 12-in. boards at 90 degrees, Laser Trac® System, extending support wings and rapid release fence.
- Positive bevel stops at 0, 33.9 and 45 degrees; left and right miter stops at 0, 15, 22.5, 31.6 and 45 degrees.
- Includes hold-down clamp and 40-tooth carbide-tipped blade. Wt. 52.75 lbs. \*

009-21239

329.99

[Get the Latest Price Online](#)



**G**  
10-INCH

**G. Craftsman 10-Inch Sliding Compound Miter Saw with AC-Powered Laser**

- Cuts up to 4-in. thick and 12-in. wide with 15-amp motor and AC-powered laser.
- Features electric brake, aluminum die cast table and nine positive left/right miter stops.
- Includes 60-T carbide-tipped blade, hold-down clamp and two sliding extensions. Wt. 46.24 lbs. \*

009-21237

249.99

[Get the Latest Price Online](#)



**8-INCH WHEEL FOR EASY TRANSPORT AND SWITCHABLE POWER STRIP**

Catalog/Online EXCLUSIVE

**H. Craftsman Bench Power Tool Workstation.**

Lightweight and durable. Measures 33H x 67L x 25W in. and supports up to a 16-foot workpiece. Three roller supports with flip stops, two sets of quick-mount attachments, built-in power strip, work light, work vise, material supports on the legs, built-in storage and 8-inch wheel with folding legs for easy transport. Wt. 77 lbs.

009-22023

249.96

\*Among products in a consumer class.

▼ Accessories/props not included.

● See page 112 for laser use and precautions.





**CRAFTSMAN®**

**PROFESSIONAL**



A



B



**SPRING-LOADED STAND**

**FOLD TO STOW AWAY, SET UP IN SECONDS**

# JOBSITE AND SHOP

Craftsman® & Craftsman Professional,

D



**6-INCH  
INCLUDES  
CASE**



E



**14-INCH**



Catalog/Online EXCLUSIVE  
**D. Craftsman 6-Inch Cutoff Saw**

- Quickly cuts conduit, steel pipe, drywall studs, PVC and rebar up to 2-in. round stock.
- 3.5-amp motor with 6-in. abrasive wheel; head lock-down chain and handle for portability; 7500 rpm (no load).
- Includes case. Imported. Warranted.\* Wt. 12 lbs.

009-26850

99.99

**Get the Latest Price Online**

**E. Craftsman 14-Inch Abrasive Chop Saw with Laser Guide**

- Powerful 15-amp motor delivers clean, precise cuts for heavy-duty jobs.
- Laser guide ensures accuracy; quick-release vise swivels 45 degrees; cast iron base.
- Includes adjusting extension. Wt. 50 lbs.\*

009-21289

219.99

**Get the Latest Price Online**

\*Warranted, see page 112.

• See page 112 for laser use and precautions.



**A. Craftsman Professional® 10-Inch Jobsite Table Saw**

- Powerful saw has all the features of a full-size table saw, plus a telescoping handle and 6-in. wheels.
- Includes new tool-less blade guard, separate riving knife, right sliding table extension, rear outfeed, dust port and more.
- 10-in., 36-tooth blade, rip fence, push stick, blade wrench, hex key and miter gauge. Warranted.\* Wt. 123 lbs.

009-21828 329.99

[Get the Latest Price Online](#)

**B. Craftsman Professional 10-Inch, 15-amp Portable Table Saw**

- Easy fold stand for effortless mobility.
- Sliding front and rear fence rails, plus an oversized miter fence.
- Includes carbide-tipped blade, push stick, guarding system, anti-kickback pawls, hex keys, miter gauge, rip fence and miter table fence.
- 8-in. wheels. Wt. 125.7 lbs.

009-21829 529.99

[Get the Latest Price Online](#)

**C. Craftsman® 10-Inch Job Site Table Saw**

- Spring assisted folding stand moves easily from storage to work site.
- Die-cast aluminum table with steel extension supports large work pieces; rip capacity up to 24 in.
- Quick-release, self-aligning fence and adjustable miter gauge on 3/4-in. wide slot facilitates accurate cross/rip cutting up to 24 in.
- Powerful 15-amp motor handles the toughest hardwoods. Wt. 50 lbs.

009-28463 289.99

[Get the Latest Price Online](#)

**INDUSTRIAL-RATED HEAVY-DUTY RIGHT AND LEFT TILT**



**81-INCH SURFACE WITH EXTENSION**

**F. Craftsman Professional 12-inch 3-hp Table Saw with Wooden Extension, Two Support Legs and Right-Tilt Arbor.**

Powerful 3-hp motor produces quality cuts. 81 x 30-in. worksurface with extensions. Depth of cut is 4 inches at 90 degrees, 2 3/4 inches at 45 degrees. Distance in front of the blade is 12 inches. 1-inch and 5/8-inch blade arbor and 5/8-inch dado arbor included. 230-volt, single-phase 3,450 rpm motor. Measures 46D x 77W x 42H in. Wt. 720 lbs.

009-22802N+ 1,599.99



**G. Craftsman Table Saw Digital Readout.**

Magnetic readout mounts easily and displays bevel angle within 1/10th degree. Auto shut-off. Wt. 1.5 lbs.

009-22575 79.99

**SAW POWER**  
® saws stand up to the job



**H. Craftsman 10-Inch Contractor Table Saw**

- 1 3/4-hp motor delivers 3550 rpm.
- Heavy-duty cast iron table features stamped steel extensions.
- 10-in. left tilt arbor; dual locking rip fence rides on front and rear aluminum rails; 4-in. dust port.
- 30-in. right and 13-in. left cut capacity.
- Quick-release blade guard system and anti-kickback pawls with 3-position riving knife.
- Includes miter gauge, blade and heavy-duty mobility kit. Wt. 305 lbs.

009-21833 599.99

[Get the Latest Price Online](#)



**J. Craftsman Professional 10-Inch Premium Hybrid Table Saw with Granite Table and Extensions**

- Granite table and extensions provide smooth flat surface for accurate cuts 40W x 27D in.
- Includes riving knife and quick-release blade guard system; fold down rear extension table.
- 37 3/8-in. steel rip fence with HPE side panels for accurate cutting.
- 30-in. right and 13-in. left cut capacity. Wt. 485 lbs.

009-22116 1,099.99

[Get the Latest Price Online](#)

bench power



# HEAVY-DUTY POWER TOOLS



5 X 6-INCH CUTS METAL

THREE SPEEDS; VISE JAWS SWIVEL UP TO 45 DEGREES



Catalog/Online EXCLUSIVE

**A. Craftsman® 5 x 6-Inch Horizontal Metal Cutting Band Saw**

- Cut ferrous and non-ferrous metals, as well as steel pipe, angle iron, conduit, brass, aluminum and copper—up to 5-in. diameter or 4 1/2 x 6-in. rectangle—with this versatile saw.
- 1/3-hp motor offers three speeds: 80/120/200 fpm.
- Shuts off automatically after cut; includes 64 1/2 x 1/2-in. blade. Warranted.\* Wt. 112 lbs. 009-21414N◆

369.99

[Get the Latest Price Online](#)



10-INCH

**B. Craftsman 10-Inch Band Saw**

- Saws cuts any wood easily with 1/8 to 1/2-in. blades, 9 5/8-in. throat and 4 5/8-in. cutting height.
- Features blade tension adjustment and upper and lower blade bearing guides to reduce friction.
- Includes blade and wheel cleaning brush. Wt. 73 lbs. 009-21400N◆

199.99

[Get the Latest Price Online](#)

**9-Inch Band Saw**

- 009-21419 Wt. 51 lbs. 144.99

[Get the Latest Price Online](#)



12-INCH

**C. Craftsman 12-inch Band Saw**

- Features steel frame with cast iron table; built-in dust port for attaching wet/dry vacs; fence and blade bearing guides.
- Powerful 3/4-hp motor delivers cutting speeds of 1450 and 3000 fpm.
- Extra-large cutting capacity; cuts wood up to 7-in. thick and 12-in. wide.
- Micro-adjustable ball-bearing guides, light, blade tracking window, blade tension gauge and 9-spoke wheels; uses 89 1/2-in. blades; includes open stand. Wt. 167 lbs. 009-22400N◆

429.99

[Get the Latest Price Online](#)

## PLANER



**D. Craftsman Professional 15-amp, 13-Inch Planer**

- Solid construction with granite table and auto-feed rate of 26 fpm.
- Delivers 10,000 rpm for 30,000 cpm.
- Features 8 preset depth gauge positions, reversible dust port, and 3 reversible HSS blades. Wt. 101 lbs. 009-21748

519.99

[Get the Latest Price Online](#)

## JOINTER/PLANER



**E. Craftsman Professional 6 1/8-Inch Jointer/Planer**

- Powerful 1 1/2-hp continuous-duty motor; cuts up to 1/8-in. deep with 3-blade cutterhead.
- 1/2-inch deep rabbeting; cast iron fence tilts 45 degrees inward and outward for bevel and chamfer cuts.
- 4-in. diameter exhaust port, industrial-style push-button switch, two push blocks and enclosed stand. Wt. 243 lbs. 009-21705

619.99

[Get the Latest Price Online](#)

## SCROLL SAW

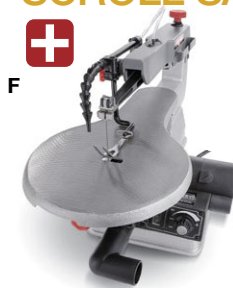

**F. Craftsman 16-Inch Variable-Speed Scroll Saw**

- Cast iron table minimizes vibration; allows left-tilt, 45-degree bevel cuts.
- Variable speeds of 400 to 1600 spm; cuts up to 2 in. at 90 degrees and up to 1 in. at 45 degrees.
- Adjustable blower keeps work area clear; built-in 1 1/4-inch vacuum port; takes 5-in. pinned and plain-end blades. Wt. 35 lbs. 009-21602

129.99

[Get the Latest Price Online](#)

## 18-INCH WITH FOOT PEDAL



**G. Craftsman 18-Inch Scroll Saw**

- On/off foot pedal; 18-in. throat depth for more versatility on larger projects.
- Offers variable speeds of 0 to 1700 spm; bevels 45 degrees left and 5 degrees right.
- Removable throat plate; tool-less blade change; up-front, top-mounted controls; two pin type and three plain-end blades. Wt. 35.5 lbs. 009-21609

219.99

[Get the Latest Price Online](#)



Share



10-INCH

**H. Craftsman 10-Inch Bench Drill Press with Laser Trac® System**

- Powerful 6-amp motor; Laser Trac feature ensures accuracy.
- Precision 1/2-in. chuck for drilling in wood/metal and sanding operations.
- Five speed settings from 620 to 3100 rpm.
- Cast iron work table measures 7 5/8 x 6 1/2 in. Wt. 54.68 lbs.\*

009-21900 139.99  
[Get the Latest Price Online](#)

**J. Craftsman Digital 12-Inch Bench Top Laser Trac® System Drill Press**

- Digital depth readout and laser guide for accuracy.
- Adjustable fence and rack-and-pinion height adjustments.
- Five spindle speeds, swivel knob, 1/2-in. chuck and an adjustable LED worklight.
- Warranted.\* Wt. 97.1 lbs.\*

009-21914 219.99  
[Get the Latest Price Online](#)  
**15-Inch Stationary Laser Drill Press**  
009-22900N♦ Wt. 174 lbs.\* 449.99  
[Get the Latest Price Online](#)



DIGITAL READ-OUT

12-INCH

**K. Craftsman Professional 20-Inch Stationary Drill Press**

- Industrial-quality drill features 1-hp continuous-duty motor, delivering 150 to 2200 rpm.
- Cast iron head and production table, push-button switch, and external depth stop with quick-change nut.
- Nine spindle speeds, 3/4-in. capacity keyed chuck and worklight. Warranted.\* Wt. 324 lbs.

009-22902N♦ 899.99  
[Get the Latest Price Online](#)  
**17-Inch Stationary Laser Drill Press**  
009-22901N♦ Wt. 206 lbs.\* 619.99  
[Get the Latest Price Online](#)



CRAFTSMAN PROFESSIONAL

20-INCH

bench power



**L. Craftsman 3-Piece Mini Turning Set**

- Excellent for turning pens.
- 8-mm spindle gouge, 1/2-in. skew chisel and 1/16-in. parting tool.
- Storage box. Wt. 1.2 lbs.

009-29818 39.99  
[Get the Latest Price Online](#)



**M. Craftsman 6-Piece Turning Tool Set with Wooden Storage Case**

- Comfortable handles for balance and control.
- Finely polished blades forged from high-speed steel—stay sharp six times longer than carbon steel blades. Wt. 5.5 lbs.

009-28596 99.99  
[Get the Latest Price Online](#)



**N. Craftsman Mini Lathe**

- Offers a 12-in. spindle capacity with 4-in. bowl-turning capacity.
- 1.2-amp, three-speed lathe turns at 1350, 2250 and 3500 rpm (no-load) for rough to fine finishing.
- Includes eye shield, 2 1/2-in. face plate, wrench, tool rest, spur center, bearing center and pen mandrel. Wt. 17 lbs.

009-22106 199.99  
[Get the Latest Price Online](#)



**P. Craftsman Midi Lathe**

- 1/2-hp, six-speed lathe features a continuous-duty motor that delivers 650 to 4000 rpm.
- 9 1/2-in. swing over tool rest base, 12-in. swing over bed and 12 indexing positions (30° apart) for intricate carving. Wt. 96 lbs.

009-21752 419.99  
[Get the Latest Price Online](#)

\*Warranted, see page 112.  
♦ See "N" suffix note on page 112.  
\* See page 112 for laser use and precautions.





# NO BETTER WAY TO SAND

## SPINDLE SANDER



A



## B 6 X 48-INCH BELT AND 9-INCH DISC



# CRAFTSMAN®



## C 2 X 42-INCH BELT AND 6-INCH DISC



## D 4 X 36-INCH BELT AND 6-INCH DISC



### A. Craftsman® Oscillating Spindle Sander

- Sand contours, arcs, and curves faster and easier on this extra-large, 18-in. cast iron worktable.
- 1/4-hp motor delivers 1,725 rpm.
- Built-in dust collection with exhaust port, rubber foot pads, on-board storage and locking paddle switch; includes six abrasive sleeves and five abrasive drums.
- Imported. Wt. 54 lbs.

009-21500 299.99

[Get the Latest Price Online](#)

### B. Craftsman 6 x 48-Inch Belt and 9-Inch Disc Sander

- Provides over 100 sq. in. of sanding surface; includes universal cast iron table and miter gauge.
- 3/4 hp, 8 amps; belt size is 6 x 48 in. with a speed of 2400 fpm.
- 9-in. disc has a speed of 3100 rpm.
- Single exhaust port provides dust collection for belt and disc operations. Wt. 93 lbs.

009-22500 269.99

[Get the Latest Price Online](#)

### C. Craftsman 2 x 42-Inch Belt and 6-Inch Disc Sander for Contour Sanding

- Table tilts to 45 degrees; belt arm operates vertically & horizontally.
- Removable platen for contour sanding; built-in dust collection port on disc table.
- 1/3 hp, 3.5 amps; belt size is 2 x 42 in. with speed of 4400 fpm; 6-in. disc size with speed of 3450 rpm.
- Table quantity of two and the material is AL; includes miter gauge. Wt. 37 lbs.

009-21513 159.99

[Get the Latest Price Online](#)

### D. Craftsman 4 x 36-Inch Belt and 6-Inch Disc Sander

- Features miter gauge, 45 degree tilting cast aluminum worktable, dust collection port, and easy-to-use belt tension controls.
- Thumb wheel for easy tracking of sanding belt.
- 1/3 hp, 3.4 amps; belt size is 4 x 36 in. and has a speed of 1100 fpm; 6-in. disc has a speed of 2200 rpm.
- Table quantity of one and the material is AL. Wt. 47 lbs.

009-21514 149.99

[Get the Latest Price Online](#)

## 8-INCH BUFFER

E



Catalog/Online EXCLUSIVE

### E. Craftsman 8-Inch Bench Top Buffer

- 3/4-hp, 7-amp, 115V motor, operates at 3450 rpm for buffing and polishing.
- Includes 8-in. diameter spiral buffing wheel and 8-in. diameter soft buffing wheel; 5/8-in. shaft with 3 1/2-in. cast iron flange. Wt. 38 lbs.

009-21181 159.99

[Get the Latest Price Online](#)

## 6-INCH BUFFER

F



### F. Craftsman 6-Inch Bench Top Buffer

- 1/2-hp, 5-amp motor operates at 3450 rpm.
- Includes 6-in. spiral and soft cotton buffing wheels. Wt. 20 lbs.

009-22625 129.99

[Get the Latest Price Online](#)



Catalog/Online EXCLUSIVE

### G. Craftsman Heavy-Duty Cast Iron Grinder/Buffer Stand

- Multi-slotted cast iron top accommodates most grinders and buffers.

• Includes cooling pot; 33H in. Wt. 60 lbs.  
009-19210 89.99

[Get the Latest Price Online](#)





# D, GRIND, CUT AND FINISH

bench power



H

6-INCH GRINDER



J

6-INCH VARIABLE-SPEED GRINDER

**H. Craftsman 6-Inch Bench Grinder**  
 • 2.1-amp motor with copper windings; flexible lamp with on/off switch; cast iron base.  
 • With 60-grit medium and 36-grit coarse grinding wheels.  
 • Imported. Warranted.\* Wt. 22 lbs.  
 009-21124 69.99  
**Get the Latest Price Online**

**J. Craftsman 6-Inch Variable-Speed Grinding Center**  
 • Quick-change wheel guards and accurate speed range of 2000 to 3450 rpm for grinding or sharpening.  
 • Stable cast iron base, wire and grinding wheels, top-mounted wheel dresser, water cooling tray, and flexible lamp with on/off switch.  
 • Large, adjustable tool rests with bit-sharpening attachment.  
 • Imported. Warranted.\* Wt. 30.8 lbs.  
 009-21154 109.99  
**Get the Latest Price Online**

**K. Craftsman Professional 8-inch Variable-Speed Bench Grinder.**  
 Variable speeds from 1,725-3,450 rpm. Quick-change wheel guards, flexible worklight with on/off switch and solid cast iron base. Large, adjustable tool rests with attachment for accurate bit sharpening, clear eye shields and spark guards. Warranted\*. Wt. 47.3 lbs.  
 009-21162 159.99



K

Catalog/Online EXCLUSIVE  
**L. Craftsman 18-inch Laser-Guided Wet Tile Saw with Stand and Diamond Blade.**  
 Get precision cuts through ceramic, granite and even marble with this laser-guided water-cooled saw. Features a 1 hp, 6.7 amp motor that delivers 3,550 rpm cutting speed. Includes two 7-inch wet cutting diamond blades, water pump and adjustable rip guide. Warranted\*. Wt. 89 lbs.  
 009-21541 299.99  
**Get the Latest Price Online**

**M. Craftsman 7-inch Wet Tile Saw.**  
 Bench top wet saw with a 7-inch blade and 4.8 amps of power cuts up to 1-inch-thick material. Table adjusts to 15, 30 and 45-degree tilt. Features stainless steel worktable with ribbed design and water collection system. Includes diamond blade, blade guard, rip fence, miter guide, wrench and manual. Wt. 17.05 lbs.▼  
 009-22320 99.99  
**Get the Latest Price Online**



L

INCLUDES TWO DIAMOND BLADES



M



\*Warranted, see page 112.  
 ▼ Accessories/props not included.



**A. new** Craftsman®  
2.5-Gallon 1.75-Peak HP  
Portable Wet/Dry Vac  
• Our smallest portable vac.  
• 4-ft. x 1 1/4-in. hose. Wt. 7.9 lbs.  
009-17611 **29.99**

Get the Latest Price Online

**B. Craftsman 9-Gallon  
3.5-Peak HP Wet/Dry Vac**  
• Includes vac, car nozzle, utility  
nozzle and wet nozzle.  
• Two 1 7/8-in. extension wands,  
hose, filter, casters and caster feet.  
Wt. 16.1 lbs.

009-17967 **59.99**

Get the Latest  
Price Online



**CRAFTSMAN®  
BASIC VACS**

- Compact—ideal for quick pick-ups and car cleaning.
- Powerful yet portable.
- Easy to store.

**+**  
**A**  
**new**  
**2.5-GALLON**

**9-GALLON**

**+**  
**B**

**6-GALLON**

**+**  
**C**

**C. Craftsman 6-Gallon  
2.5-Peak HP Wet/Dry Vac**

- Includes vac, car nozzle and utility nozzle.
  - Two 1 7/8-in. extension wands, hose, filter, casters and caster feet. Wt. 14.9 lbs.
- 009-17965 **44.99**  
Get the Latest Price Online

**CRAFTSMAN  
PROFESSIONAL®  
HEAVY-DUTY VACS FOR  
PROFESSIONAL JOBS**

- Heavy duty—for demanding jobs.
- With more suction power.
- Accessory bag for handy storage.



**+**  
**D**  
**16-GALLON**

**D. Craftsman Professional®  
16-Gallon 6.5-Peak HP Wet/Dry Vac**

- Includes vac, car nozzle, utility nozzle and wet nozzle.
  - Two 2 1/2-in. extension wands, crevice tool, storage bag, pro hose, fine dust filter, wheels and casters. Wt. 38.8 lbs.
- 009-17778 **199.99**

Get the Latest Price Online



**GUTTER KIT**

**+**

**PUMP OUT**

**+**

**VAC ACCESSORIES &  
CAR CLEANING KITS**

**+**



**J. Craftsman Gutter Kit**

- Fits most Craftsman vacs with a 2 1/2-in. hose.
  - Includes gutter nozzle, blower nozzle and two extension wands. Wt. 3.3 lbs.
- 009-16935 **19.99**

Get the Latest Price Online



**K. Craftsman Pump Out**

- Attaches to most vacs with a drain.
  - Wt. 4.4 lbs.
- 009-16952 **39.99**

Get the Latest Price Online



**L. Craftsman 5-Piece Car Cleaning Kit**

- Fits most Craftsman vacs.
  - 1 1/4-in. x 11-ft. hose, car nozzle, crevice tool, dusting brush and connector. Wt. 3.2 lbs.
- 009-16994 **19.99**

Get the Latest Price Online



**M. Craftsman Professional 10-Foot Hose**

- Fits 2 1/2-in. and 1 7/8-in. accessories.
  - Four times more durable than the standard hose. Wt. 4 lbs.
- 009-16932 **39.99**

Get the Latest Price Online



**N. Craftsman 5-Piece Deluxe Car Cleaning Kit**

- Fits most Craftsman vacs.
  - Includes claw nozzle, 1 1/4-in. x 10-ft. hose, connector, soft and stiff dusting brushes, and crevice tool. Wt. 3.9 lbs.
- 009-16989 **39.99**

Get the Latest Price Online



# MULTIPLE APPLICATIONS

wet/dry vacs

## E. Craftsman 20-Gallon 6.5-Peak HP Wet/Dry Vac

- Includes vac, car nozzle, utility nozzle and wet nozzle.
- Two 2 1/2-in. extension wands, dust bag, hose, muffler/diffuser, filter, casters and caster feet. Wt. 32 lbs.

009-17762 119.99

**Get the Latest Price Online**

## 16-Gallon 6-Peak HP Wet/Dry Vac

009-17761 Wt. 27 lbs. 99.99

**Get the Latest Price Online**

## 12-Gallon 5-Peak HP Wet/Dry Vac

009-17765 Wt. 27 lbs. 79.99

**Get the Latest Price Online**

## F. new Craftsman 12-Gallon 5-Peak HP Wet/Dry Vac with Detachable Blower

- Includes detachable blower; delivers up to 175 mph air speed.
- Large on/off switch; 8 accessories. Wt. 27 lbs.

009-17557 89.99

**Get the Latest Price Online**

## 16-Gallon 6.5-Peak HP Wet/Dry Vac with Detachable Blower

009-17066 Wt. 32 lbs. 119.99

**Get the Latest Price Online**

## G. Craftsman 5-Gallon 5-Peak HP Wall Vac

- Includes vac, car nozzle, utility nozzle, crevice tool, dusting brush and muffler/diffuser.
- Two 1 7/8-in. extension wands, two hoses, vac mount, filter and accessory bin. Wt. 25 lbs.

009-17925 99.99

**Get the Latest Price Online**

## H. new Craftsman 4-Gallon 5-Peak HP Portable Wet/Dry Vac

- Lightweight to carry anywhere.
- Includes hose, extension wands, crevice tool and more. Wt. 16.9 lbs.

009-17612 79.99

**Get the Latest Price Online**

## CRAFTSMAN ADVANCED & SPECIALTY VACS

- Most versatile.
- Excellent for woodworking, construction, garage and yard clean-up.



+

+

+

+

## 1 7/8-INCH KIT



P +

## P. Craftsman 1 7/8-Inch Accessory Kit

- Fits most Craftsman vacs with a 1 7/8-in. hose.
- 2 extension wands, utility nozzle, car nozzle, crevice tool and dusting brush. Wt. 1.7 lbs.

009-16998 29.99

**Get the Latest Price Online**

## 2 1/2-INCH KIT



+

## Q. Craftsman 2 1/2-Inch Accessory Kit

- Fits most Craftsman vacs with a 2 1/2-in. hose.
- 2 extension wands, wet & dry nozzles, crevice tool and dusting brush. Wt. 3.7 lbs.

009-16919 39.99

**Get the Latest Price Online**

## HEAVY-DUTY KIT



+

## R. Craftsman Heavy-Duty Accessory Kit

- Fits most Craftsman vacs.
- 1 7/8 & 2 1/2-in. adapters; floor tool with squeegee.
- 2 extension wands, claw nozzle, crevice tool and dusting brush. Wt. 5.4 lbs.

009-17833 49.99

**Get the Latest Price Online**

## QWIK LOCK FILTERS FOR EASIER CHANGES



+

+

+

+

## S. Craftsman Hepa Material Replacement Filter

- 99% efficiency for particles down to 0.3 micron.
- For use with 5-gal. and larger vacs made 1988 and after. Wt. 0.92 lb.

009-17912 29.99

**Get the Latest Price Online**

T. Craftsman Fine Dust Replacement Filter Wt. 0.75 lb. 009-17907 22.99

**Get the Latest Price Online**

## U. Craftsman Red Stripe General Purpose Replacement Filter Wt. 0.7 lb.

- 99% efficiency for particles down to 0.3 micron.
- For use with 5-gal. and larger vacs made 1988 and after. Wt. 0.92 lb.

009-17816 16.99

**Get the Latest Price Online**

## V. Craftsman Wet Application Vac Filter Wt. 0.9 lb.

009-17292 16.99

**Get the Latest Price Online**



# TAKING PRECISION TO A NEW LEVEL



Catalog/Online EXCLUSIVE

## A. Craftsman® 48-Inch Digital Level with Soft Storage Case

- 2-inch LCD screen displays in degrees, inch/foot or percent of grade; accurate to ± 0.1 degrees.
- Memory recall for up to nine measurements; zero button calibrates to any surface.
- Includes soft case. Wt. 2.58 lbs. 009-79583

119.99

[Get the Latest Price Online](#)

**INCLUDES CASE**



A



**DIGITAL READOUT**



C



## C. Craftsman® Stud Finder with SpotLite® Pointing System

- Finds metal studs up to 1 1/2-in. deep.
- SpotLite® Pointing System shines bright light to indicate stud center.
- Dual-Depth Scanning adjusts to DeepScan® mode for thicker surfaces. Wt. 0.45 lb.

009-49062

[Get the Latest Price Online](#)

19.99

## Stud Finder with LED Display

009-49061 Wt. 0.25 lb.

[Get the Latest Price Online](#)

14.99

**BRIGHT LIGHT SHOWS STUD CENTER**



B



## B. Craftsman® 9-Inch Magnetic Torpedo Level

- Three vials: 1 plumb, 1 level, and one 45 degrees.
- Top-read window with V-groove working edge. Wt. 0.4 lbs.

009-39829

[Get the Latest Price Online](#)

9.99



D



## D. Craftsman Digital Torpedo Level

- Easily read for calculating angles, grades and plumb.
- Large, back-lit LCD screen.

- Includes manual and carrying case.

Wt. 0.8 lb.

009-48295

[Get the Latest Price Online](#)

34.99



E



## E. Craftsman® 2-Piece Lockback Utility Knife Set

- Unique blade changing mechanism is fast and requires no tools.
- Hand-polished wood handles.
- Second mini-knife can be put on a keychain.

Wt. 0.75 lb.

009-94835

[Get the Latest Price Online](#)

19.99

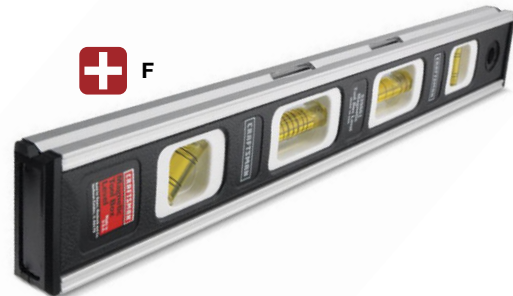

F

## F. Craftsman 12-Inch Magnetic Tool Box Level

- 2 level vials: one pitch, one plum.
- Sized for tool box. Wt. 0.5 lb.

009-39861

[Get the Latest Price Online](#)

12.99

• See page 112 for laser use and precautions.





Catalog/Online EXCLUSIVE

**G. Craftsman® 3-Piece Locking Flex Pry Bar Set**

- Select the angle to get the leverage you need—pivoting head flexes 180 degrees with 13 locking positions; push-button spring release.

- 8, 16 and 24-in. bars. Separate prices total \$121.97. Wt. 10.16 lbs. 009-87653 99.97

**Get the Latest Price Online**

**8-Inch**  
009-43295 Wt. 1 lb. 24.99

**Get the Latest Price Online**

**16-Inch**  
009-43296 Wt. 2 lbs. 36.99

**Get the Latest Price Online**

**24-Inch**  
009-43297 Wt. 5 lbs. 59.99

**Get the Latest Price Online**

**33-Inch**  
009-87652 Wt. 6.94 lbs. 79.99

**Get the Latest Price Online**



**13 POSITIONS,  
180 DEGREES**



G

**CRAFTSMAN®**



**CRAFTSMAN  
PROFESSIONAL**



H



Catalog/Online EXCLUSIVE

**H. Craftsman 5-Piece Screwdriver Pry Bar Set**

- Ergonomic grips and curved ends provide added leverage.
- Blade sizes 1/4 x 8, 3/8 x 12, 3/8 x 17, 1/2 x 25 and 1/2 x 31 in. Made in USA. Warranted.\* Wt. 8 lbs.

009-43279 59.99

**Get the Latest Price Online**

**3-Piece Screwdriver Pry Bar Set**

Sizes 12, 17, 25-in. 009-43278 Wt. 4.5 lbs. 39.99

**Get the Latest Price Online**

Catalog/Online EXCLUSIVE

**J. Craftsman Professional® 5-Piece Curved-Blade Pry Bar Set**

- Patented comfort-grip handles.
- Capped for use with hammers.
- Blade sizes: 3/8 x 12, 3/8 x 17, 1/2 x 25, 3/8 x 10 and 1/2 x 31 in. Warranted.\* Wt. 7.75 lbs.

009-47410 59.99

**Get the Latest Price Online**

**3-Piece Curved-Blade Pry Bar Set**

Includes 12, 17 and 25-in. blades. 009-43288 Wt. 4 lbs. 49.99

**Get the Latest Price Online**

**CARRY-ALONG COMPANIONS**

**RELIABLE TOOL BAGS & HANDY TOTES**



**K 12-INCH TOTE**



**CRAFTSMAN®**

**K. Craftsman 12-Inch Tote**

- Metal tape measure clip; foam rubber grip.
- 16 elastic storage loops; large mesh netted external pockets.
- 2 velcro straps to hold levels. Wt. 1.95 lbs.

009-37538 Red/Black

009-37546 Black/Blue

009-37545 Black/Green

009-37544 Black/Tan

**Get the Latest Price Online**

12.99



**L 2-PIECE SET**



**L. Craftsman 16- and 20-Inch, 2-Piece Bag Set**

- Wide-opening design for easy tool access.
- Reinforced material for ultimate durability.
- Three mesh and three regular exterior pockets. Wt. 3.25 lbs.

009-37540

**Get the Latest Price Online**

24.99



shopyourway rewards join now. earn today. it's free.

general purpose



# CRAFTSMAN®



A

### A. Craftsman® 24-Piece Screwdriver Set

- Phillips and Torx® blade tips provide tight tolerance and fit.
- Set includes 10 slotted screwdrivers, 7 Phillips screwdrivers, 1 pocket 4-way, 1 scratch awl, and 5 Torx® screwdrivers. Wt. 4 lbs.

009-47155 29.99

[Get the Latest Price Online](#)

## DIAL-A-BIT QUICK CHANGE SYSTEM

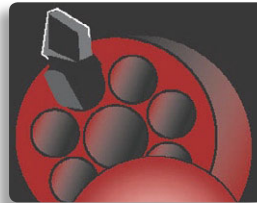

B



## MAGNETIC & RATCHETING

### B. Craftsman Ratcheting Magnetic Screwdriver with Bit Storage

- Ergonomic design; six-bit storage system lets you dial to the bit you want.

- 5 slotted, 4 Phillips, 6 Torx®, 4 square drive and 6 hex shank single side bits. Warranted.\* Wt. 1 lb.

009-47144 19.99

[Get the Latest Price Online](#)



# TAKE A NEW DRIVER FOR A SPIN

Try a new twist on timeless classics



C

### C. Craftsman 42-Piece Screwdriver Set

- 13 slotted, 9 Phillips, 6 Torx®, 2 offsets, 1 pocket 4-way, 1 magnetic bit driver, and 10-pc. bit block set.

- Color coded: red for slotted, clear for Phillips.

• Warranted.\* Wt. 6.1 lbs. 009-41042 54.99

[Get the Latest Price Online](#)

### 18-Piece Screwdriver Set

- 9 slotted, 7 Phillips, 1 offset, 1 4-way.

009-41608 Wt. 2.81 lbs. 24.99

[Get the Latest Price Online](#)

### 29-Piece Screwdriver Set

- 12 slotted, 8 Phillips, 6 Torx®, 2 offsets, 1 4-way.

009-41029 Wt. 4.1 lbs. 44.99

[Get the Latest Price Online](#)

## 4-IN-1 SCREW DRIVER



D

### D. Craftsman 4-in-1 Screwdriver

- Interchangeable double-ended bits: 3/16-in. and 1/4-in. slotted; Phillips #1 and #2.

- Bits store in shaft. Warranted.\* Wt. 0.4 lb.

009-41161 9.99

[Get the Latest Price Online](#)



latest price online



## RETRACTABLE BIT CHANGE SYSTEM



TWIST TO SELECT BIT



PUSH BIT HOLDER IN



BIT LOCKS IN PLACE



CHANGED IN LESS THAN 2 SECONDS



### E. Craftsman Autoloading Multi-Bit Screwdriver

- Autoloader exchanges screwdriver bits in less than 2 seconds.
- Six magnetic bits: P1, P2, P3; slotted 1/4, 3/16, 1/8 in.
- Bits are removable, replaceable and customizable. Wt. 0.5 lb.

009-47380

[Get the Latest Price Online](#)

19.99

Catalog/Online EXCLUSIVE

### F. Craftsman 109-Piece Screwdriver Set

- 19 slotted, 10 Phillips, 2 Robertson junior, 1 Reed Prince.
- 7 Torx®, 2 offset, 1 speed driver, 1 scratch awl.
- 4-way pocket screwdriver, magnetic shaft screwdriver, 64 security/standard bits with holders.
- Separate prices total over \$250. Warranted.\* Wt. 9.8 lbs.

009-29499

[Get the Latest Price Online](#)

129.99

Catalog/Online EXCLUSIVE

### G. Craftsman Professional® 25-Piece Screwdriver Set

- 24 screwdrivers: 11 slotted, 7 Phillips, 6 Torx®; plus a scratch awl.
- Separate prices total \$211.75. Wt. 7.33 lbs.

009-47205

[Get the Latest Price Online](#)

139.99



shopyourway  
rewards join now. earn today. it's free.

\*Warranted, see page 112.



# HAMMERING OUT THE DETAILS

Put a great brand in your hand



## PRECISION MACHINED STRIKING FACE ASSURES UNIFORMITY

Catalog/Online EXCLUSIVE  
**A. Craftsman® 5-Piece Steel Handle Ball Peen Hammer Set**

- Patented "Power Plug" shock-absorbing core reduces vibration and shock transfer to user's arm, wrist and elbow.
- Includes 8, 12, 16, 24 and 32-oz. hammers. Wt. 12 lbs.

009-38528 99.99  
**Get the Latest Price Online**



Catalog/Online EXCLUSIVE  
**B. Craftsman 5-Piece Hickory Handle Ball Peen Hammer Set**

- 12-oz. steel core head hammer with dual plastic tips.
- Four ball peen hammers with 12, 16, 24 and 32-oz. drop-forged, heat-treated heads.
- Separate prices total \$81.95. Wt. 8.5 lbs.

009-38074 59.99  
**Get the Latest Price Online**

**16-Ounce Hickory Handle Ball Peen Hammer**

009-38465  
 Wt. 1.3 lbs. 15.99  
**Get the Latest Price Online**



Catalog/Online EXCLUSIVE

**C. Craftsman 3-Piece Hammer, Bar and Puller Set**

- 15-in., reversed hook pry bar increases leverage of the "sweep" claw.
- 11 3/4-in. nail puller offers excellent leverage and increased strength.
- 19-oz., steel-handled hammer magnetic nail holder and side nail puller. Wt. 5 lbs.

009-87773 49.99  
**Get the Latest Price Online**

**D. Craftsman 16-Ounce Tubular Handle Curved Claw Hammer**

- Shock-absorbing hickory plug.
- Third claw pulls nails in tight places.
- Synthetic rubber grip. Wt. 1.6 lbs.

009-38125 16.99  
**Get the Latest Price Online**

**16-Ounce Forged Steel Handle Curved Claw Hammer**

009-38127 Wt. 1.7 lbs. 19.99  
**Get the Latest Price Online**

**E. Craftsman 48-Ounce Double-Faced Engineer's Hammer**

- 15-in., heavy-duty solid fiberglass handle; contoured molded grip.
- Large crowned striking face; overstrike guard. Wt. 4.2 lbs.

009-38261 21.99  
**Get the Latest Price Online**



**F. Craftsman Professional® Bench Vise.**

- 65,000 psi tensile ductile iron body parts provide mass and strength.
- Jaw face is 4 1/2-in. wide with a 4 in. opening and a 3 1/2-in. depth. Wt. 4.2 lbs.
- Fully enclosed spindle/nut assembly. Wt. 40.75 lbs.

009-51888 129.99  
**Get the Latest Price Online**

**G. Craftsman® Heavy-Duty Vises**

- Precision-machined anvil; extra channel support on back jaw.
- Smooth on one side for no-mar gripping, serrated on the other.
- 6-in. vise has smooth jaw face. Warranted.\* Order from chart below.

G. CRAFTSMAN HEAVY-DUTY VISES						
Catalog No.	Jaw Opening	Max. Capacity	Pipe Depth	Throat Size, in.	Wt., lbs.	Price
009-51854	4 in.	4 3/4 in.	2 5/8 in.	1/8-2	19.5	\$54.99
009-51855	5 in.	5 3/4 in.	3 7/16 in.	1/8-2 1/2	28.5	64.99
009-51856	6 in.	6 3/4 in.	3 11/16 in.	1/8-2 1/2	39.5	74.99

**Get the Latest Price Online**



RUST RESISTANT;  
DOUBLE HEAT  
TREATED FOR  
DURABILITY

general purpose



## CHISELS



### H. Craftsman® 16-Piece Punch, Chisel and Alignment Set

• Includes pin punch, center punch, aligning tool, cold chisels and nail sets. Wt. 6.85 lbs.  
009-43113 44.99

[Get the Latest Price Online](#)

**12-Piece Chisel and Alignment Set**  
009-43115 Wt. 6.5 lbs. 29.99

[Get the Latest Price Online](#)

**5-Piece Punch and Alignment Set**  
009-04285 Wt. 1 lb. 10.99

[Get the Latest Price Online](#)

Catalog/Online EXCLUSIVE

### J. Craftsman 28-Piece Punch, Chisel and Alignment Set

• Four 4-in. nail sets; one prick punch; two center punches; six pin punches; four alignment tools; 16-in. pry bar; six cold chisels; four 12-in. cold chisels.

• Separate prices total \$171.28. Wt. 9.47 lbs.  
009-43164 79.99

[Get the Latest Price Online](#)

### 20-Piece Super Duty Punch and Chisel Tool Set

009-43163 Wt. 4.75 lbs. 49.99

[Get the Latest Price Online](#)

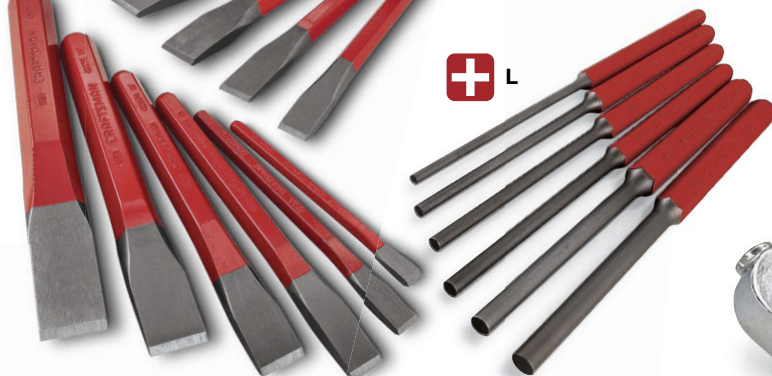

Catalog/Online EXCLUSIVE

### L. Craftsman 6-Piece Long Pin Punch Set

• Sizes: 5/32 x 7 1/2, 3/16 x 7 1/2, 7/32 x 7 1/2, 1/4 x 7 1/2, 5/16 x 7 1/2 and 3/8 x 7 1/2 in.

• Separate prices total \$35.94. Warranted.\* Wt. 1 lb.

009-43160 24.99

[Get the Latest Price Online](#)

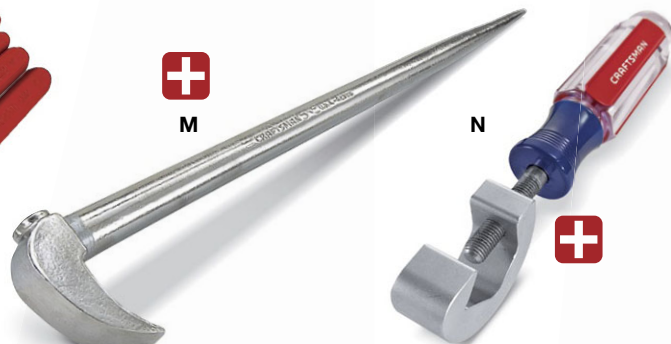

### M. Craftsman 16-Inch Rolling Wedge Bar

• 90-degree, polished rolling head. • 9/16-in. diameter. Wt. 1.25 lbs.

009-42892 19.99

[Get the Latest Price Online](#)

### N. Craftsman Punch and Chisel Holder

• Designed to keep hands away from shaft of chisels to avoid being accidentally struck.

• Securely clamps onto hex stock up to 3/4 in. • Heat-treated head and screw. Made in USA. Wt. 0.4 lb.

009-42839 12.99

[Get the Latest Price Online](#)

Catalog/Online EXCLUSIVE

### K. Craftsman 11-Piece Cold Chisel Set with Pry Bar

• 10 cold chisels (1/4 x 4, 3/8 x 5, 1/2 x 5 3/4, 5/8 x 6, 3/4 x 6 1/2, 7/8 x 7 1/2, 1/2 x 12, 5/8 x 12, 3/4 x 12, 7/8 x 12 in.); one 16-in. pry bar.

• Separate prices total \$77.20. Warranted.\* Wt. 6.67 lbs.

009-43161 49.99

[Get the Latest Price Online](#)

\*Warranted, see page 112.



# GRAB THE RIGHT PLIERS

Craftsman® style, comfort grips and new uses for a vital tool



**CRAFTSMAN®**

**SOLID-JOINT PLIERS**

**COMFORT GRIP HANDLES**

**ALLOY STEEL FOR DURABILITY**

Catalog/Online EXCLUSIVE  
**A. Craftsman® 11-Piece Solid-Joint Pliers Set**  
 • Includes 6-in. long nose, 6-in. bent long nose, 8-in. linesman, 6-in. diagonal cutter, 8-in. duckbill, 8-in. long nose, 8-in. long reach long nose, 7-in. diagonal cutter, 7-in. bent wide jaw cutter, 4-in. diagonal cutter and 4 1/2-in. long nose.  
 • Separate prices total \$168.89. Lifetime Warranty.\*  
 Wt. 4.9 lbs.▼  
**009-45450 119.99**



**A**



**B SLIP-JOINT**

Catalog/Online EXCLUSIVE  
**B and C. Craftsman Pliers Sets**  
 • Flush rivet design allows closer access to worksurfaces and provides improved strength.  
**B. Craftsman 3-Piece Slip-Joint Pliers Set**  
 • Includes 6 3/4, 8 and 10-in. sizes.  
 • Wire-cutting edge, three working surfaces plus two jaw openings.  
 • Separate prices total \$35.47. Wt. 2.13 lbs.  
**009-45233 29.99**  
**Get the Latest Price Online**



**C ARC-JOINT**

**C. Craftsman 3-Piece Arc-Joint Pliers Set**  
 • Includes 9 1/2, 13 and 16 1/2-in. sizes.  
 • Separate prices total \$87.47. Wt. 5.93 lbs.  
**009-45439 69.99**  
**Get the Latest Price Online**



**D MULTI-PURPOSE**

Catalog/Online EXCLUSIVE  
**D and E. Craftsman Multi-Purpose Pliers Sets**  
 • Made of hardened, tempered alloy steel; comfort-grip handles.  
 • Solid-joint pliers designed for superior cutting and gripping.  
 • Arc-joint and slip-joint pliers have flush rivet design for closer access to worksurfaces. Lifetime Warranty.\*



**E MULTI-PURPOSE**

**D. Craftsman 4-Piece Pliers Set**  
 • Includes 7-in. diagonal, 8-in. long nose, 6 3/4-in. slip-joint and 9 1/2-in. arc joint.  
 • Separate prices total \$58.96. Wt. 2.44 lbs.  
**009-45235 39.99**  
**Get the Latest Price Online**

**E. Craftsman 6-Piece Pliers Set**  
 • Includes 6-in. diagonal cutting, 8-in. duckbill, 8-in. linesman, 8-in. long nose, 6 3/4-in. slip joint and 9-in. arc joint.  
 • Separate prices total \$96.94. Wt. 3.92 lbs.  
**009-45408 69.99**  
**Get the Latest Price Online**



**F**

Catalog/Online EXCLUSIVE  
**F. Craftsman 8-Piece Solid-Joint Pliers Set**  
 • Includes 6-in. diagonal cutting, 8-in. long reach, 8-in. duckbill, 7-in. diagonal, 7-in. linesman, 6-in. long nose, 8-in. long nose and 6-in. bent long nose.  
 • Separate prices total \$138.42. Lifetime Warranty.\* Wt. 4.12 lbs.  
**009-50494 99.99**  
**Get the Latest Price Online**



**G**

**LAMINATED**  
 Catalog/Online EXCLUSIVE  
**G. Craftsman 6-Piece Laminated Pliers Set**  
 • Coated, laminated steel offers excellent corrosion resistance.  
 • Includes 6-in. diagonal cutter, 6 1/2-in. slip joint and long nose, 8-in. adjustable and slip joint, and 10-in. adjustable-joint pliers.  
 • Separate prices total \$56.44. Wt. 4.35 lbs.  
**009-45746 39.99**  
**Get the Latest Price Online**  
**3-Piece Laminated Pliers Set**  
**009-45743 Wt. 2 lbs. 19.99**  
**Get the Latest Price Online**



**H**

**H. Craftsman® 3-Piece Adjustable Wrench Set**  
 • Includes 6-, 8- and 10-in. sizes.  
 • Tapered heads for better access.  
 • Warranted.\* Wt. 1.8 lbs.  
**009-44664 34.99**  
**Get the Latest Price Online**  
**2-Piece Adjustable Wrench Set**  
 10- and 12-in. sizes.  
**009-44012 Wt. 2.25 lbs. 34.99**  
**Get the Latest Price Online**



**J**

**J. Craftsman 3-Piece Locking Pliers Set**  
 • Easy-release pliers lock with one hand and release with a push of a button.  
 • Cushioned grip for less hand fatigue.  
 • 6, 7, 10-in. Wt. 2.64 lbs.  
**009-45713 39.99**  
**Get the Latest Price Online**  
**2-Piece Locking Pliers Set**  
**009-45712 Wt. 2.2 lbs. 29.99**  
**Get the Latest Price Online**



re



**K. Craftsman® Evolv™ 3-Piece Adjustable Wrench Set, Ergonomic Grip**  
 • Includes 6-, 8- and 10-in. styles. Wt. 2 lbs.  
 009-10063 **16.99**  
[Get the Latest Price Online](#)  
**3-Piece Adjustable Wrench Set, Regular Grip**  
 009-10064 Wt. 2 lbs. **11.99**  
[Get the Latest Price Online](#)



**L. Craftsman Evolv™ 5-Piece Pliers Set**  
 • Five pliers styles for most handyman jobs.  
 • Set includes 6-in. long nose, 6-in. diagonal, 6-in. slip joint, 7-in. linesman, and 8-in. groove joint. Wt. 2.8 lbs.  
 009-10047 **17.99**  
[Get the Latest Price Online](#)



**M. Craftsman Evolv™ 3-Piece Pliers and Adjustable Wrench Set**  
 • 8-in. adjustable wrench, 8-in. slip joint pliers, 10-in. groove joint pliers.  
 • Pliers have ergonomic grips.  
 • Parallel jaws. Wt. 2.5 lbs.  
 009-10045 **11.99**  
[Get the Latest Price Online](#)

# TOOLS THAT "EVOLVE" WITH YOU

Exceptional value, cool tools

general purpose



**N. Craftsman Evolv™ 6-Piece Precision Screwdriver Set**  
 • Work in tight places too small for standard screwdrivers.  
 • Slotted: 1/16-in., 5/64-in., 3/32-in., 1/8 x 2 1/2-in.; Phillips: #00, #0 x 2 1/2-in. Wt. 1.2 lbs.  
 009-10066 **9.99**  
[Get the Latest Price Online](#)



**P. Craftsman Evolv™ 6-Piece Screwdriver Set**  
 • Slotted: 3/16 x 3-in., 1/4 x 4-in., 5/16 x 6-in.  
 • Phillips: #1 x 3-in., #2 x 4-in., #3 x 6-in. Wt. 2.2 lbs.  
 009-10067 **9.99**  
**10-Piece Screwdriver Set** Four additional sizes.  
 009-10068 Wt. 2.8 lbs. **14.99**  
[Get the Latest Price Online](#)



**Q. Craftsman Evolv™ 6-Piece Mini Pliers Set**  
 • Work in tight places too small for standard pliers.  
 • 4-in. diagonal, 4-in. long nose, 5 1/2-in. needle nose, 4-in. end cutting nipper, 4-in. flat nose, 4-in. bent nose. Wt. 1.35 lbs.  
 009-10060 **14.99**  
[Get the Latest Price Online](#)



**R. Craftsman Evolv™ 3-Piece Locking Pliers Set**  
 • Locks in gripped position; knob adjusts level of tension for fasteners small to large.  
 • Ergonomic grips for comfort.  
 • 6-, 7- and 10-in. sizes. Wt. 3.03 lbs.  
 009-10061 **19.99**  
[Get the Latest Price Online](#)



CRAFTSMAN®

evolv™  
durable, affordable, everyday tools.

# TOOL SETS THAT DEFINE for garage

A INCLUDES  
CASE



## A. Craftsman® Evolv™ 200-Piece Mechanic's Tool Set

- Dual material teardrop QR ratchets, 1/4- and 3/8-in. drive; 1/4-in. extension bar; two 3/8-in. extension bars; spinner handle/bit coupler.
- 34 1/4-in. drive sockets; 27 3/8-in. drive sockets; 10 1/2-in. drive sockets.
- Spark plug socket; 3/8-in. adapter.
- 14 combination wrenches; 50 screwdriving bits/holders; 40 hex key set, long nose pliers.
- 4 screwdrivers; 12 nut driver bits. Wt. 15.76 lbs.

009-10026 99.99

[Get the Latest Price Online](#)

Catalog/Online EXCLUSIVE

## B. Craftsman Evolv™ 101-Piece Mechanic's Tool Set

- Teardrop QR ratchet; 1/4- and 3/8-in. extension bars; spinner handle.
- 18 1/4-in. drive sockets; 18 3/8-in. drive sockets; 13 3/8-in. drive deep sockets.
- 3/8-in. adapter; 1/4-in. square to hex bit adapter.
- 10 combination wrenches; 36 screwdriving bits/holders. Wt. 11 lbs.

009-10025 49.99

[Get the Latest Price Online](#)

## 77-Piece Mechanic's Tool Set

009-10024 Wt. 5.95 lbs. 39.99

[Get the Latest Price Online](#)

## 55-Piece Mechanic's Tool Set

009-10023 Wt. 3.53 lbs. 29.99

[Get the Latest Price Online](#)



B



INCLUDES  
CASE



C



## C. Craftsman Evolv™ 22-Piece 1/4-Inch Drive Tool Set

- 10 inch sockets (5/32 thru 1/2 in.); 10 metric sockets (4 thru 13 mm).
- 1/4-in. drive ratchet and 4-in. extension bar. Wt. 1.33 lbs.

009-10034

14.99

[Get the Latest Price Online](#)

## 20-Piece 3/8-Inch Drive Tool Set

- 9 inch sockets (3/8 thru 7/8 in.); 9 metric sockets (10 thru 18 mm); 3/8-in. drive ratchet and 6-in. extension bar. Wt. 2.43 lbs.

009-10035 Wt. 2.43 lbs.

24.99

[Get the Latest Price Online](#)



D



## D. Craftsman Evolv™ 14-Piece Combination Wrench Set

- Easy to clean; full polish; great in tight spaces.
- 7 standard (1/4, 5/16, 3/8, 7/16, 1/2, 9/16, 5/8 in.); 7 metric (8, 10, 11, 12, 13, 14, 15 mm). Wt. 2.6 lbs.

009-10055

19.99

[Get the Latest Price Online](#)



E



## E. Craftsman Evolv™ 13-Piece Quick Fit Nut Driver Set with Case

- Dual material quick fit handle any one of the 12 single-sided nut driver blades.
- Blade sizes include 6 standard (3/16, 1/4, 5/16, 3/8, 7/16, 1/2 in.); 6 metric (5, 6, 8, 10, 11, 12 mm).
- Handle can also be used as a T-handle for additional leverage. Wt. 1.32 lbs.

009-14064

19.99

[Get the Latest Price Online](#)



# VALUE AND SELECTION

and home



general purpose

F  
+



**F. Craftsman Evolv™ 9-Piece 1/2-Inch Drive Socket Set, Inch**  
 • Standard 12-pt. sockets (3/8, 7/16, 1/2, 9/16, 5/8, 11/16, 3/4, 13/16, 7/8 in.).  
 • Large size markings. Wt. 1.54 lbs.  
 009-10042 12.99  
[Get the Latest Price Online](#)

**9-Piece 1/2-Inch Drive Socket Set, Metric Sizes 10 thru 18 mm.**  
 009-10043 Wt. 1.43 lbs. 12.99  
[Get the Latest Price Online](#)

**9-Piece 3/8-Inch Drive Socket Set, Inch Sizes 3/8 thru 7/8 in.**  
 009-10039 Wt. 1.1 lbs. 9.99  
[Get the Latest Price Online](#)

**9-Piece 3/8-Inch Drive Socket Set, Metric Sizes 10 thru 18 mm.**  
 009-10040 Wt. 1.1 lbs. 9.99  
[Get the Latest Price Online](#)

H  
+



**H. Craftsman Evolv™ 7-Piece Hex Bit Socket Set, Inch**  
 • Large size markings for faster identification.  
 • Sizes: 1/8, 5/32, 3/16, 7/32, 1/4, 5/16, 3/8 in. Wt. 0.85 lb.  
 009-10044 9.99  
[Get the Latest Price Online](#)

**7-Piece HexBit Socket Set, Metric Sizes 3 thru 8, 10 mm.**  
 009-10058 Wt. 0.85 lb. 9.99  
[Get the Latest Price Online](#)

J  
+



**J. Craftsman Evolv™ 7-Piece Torx® Bit Socket Accessory Set**  
 • Sizes include: T15, T20, T25, T30, T40, T45, T50. Wt. 0.81 lb.  
 009-01005 9.99  
[Get the Latest Price Online](#)



G  
+

**G. Craftsman Evolv™ 24-Piece Homeowner Tool Set**  
 • Features a multiple pocket bag with a project parts tray and ergo-grip tools for comfort.  
 • Five precision screwdrivers (1/16, 3/32, 1/8, #00, #0 x 2 1/2-in.); 13 oz. fiberglass hammer; 8-in. slip joint and 6-in. long nose pliers; 6-in. adjustable wrench; 16-ft. x 3/4-in. tape measure; utility knife; bit driver; 10 screwdriver bits. Wt. 8.5 lbs.  
 009-10202 39.99  
[Get the Latest Price Online](#)

**52-Piece Homeowner Tool Set**  
 009-01003 Wt. 8.6 lbs. 49.99  
[Get the Latest Price Online](#)

K  
+

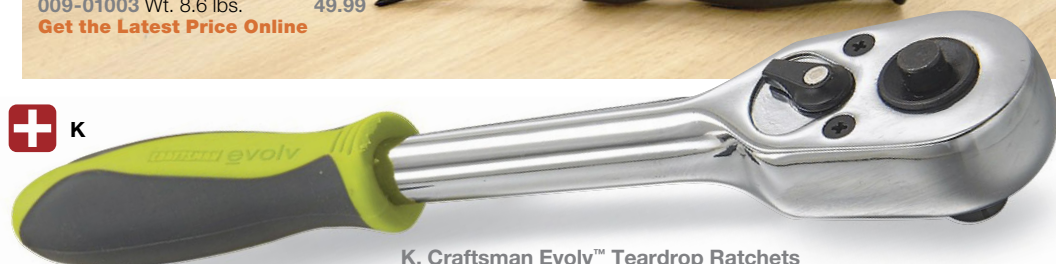

**K. Craftsman Evolv™ Teardrop Ratchets**  
 • Durable teardrop design fits in tight spaces while quick-release head makes size changes easy.  
 009-10030 1/4-in. drive. Wt. 0.36 lb. 11.99  
 009-10031 3/8-in. drive. Wt. 0.7 lb. 14.99  
 009-10032 1/2-in. drive. Wt. 1.4 lbs. 19.99  
[Get the Latest Price Online](#)

L  
+



**L. Craftsman Evolv™ 3/8-Inch Drive Speeder Ratchet**  
 • Handle rotates and extends to a crank position for more speed. Wt. 1.2 lbs.  
 009-10203 29.99  
[Get the Latest Price Online](#)



# WHY CRAFTSMAN FOR mechanic's

**AN ENORMOUS  
SELECTION OF  
MECHANIC'S  
TOOLS,  
SOCKETS  
AND WRENCHES**

**SUPERIOR  
HAND TOOL  
INNOVATIONS  
TO GET THE  
JOB DONE  
RIGHT**

**CRAFTSMAN®  
HAND TOOLS  
STILL  
GUARANTEED  
FOR LIFE\*\***

## DID YOU KNOW?

Decades ago, Sears revolutionized the mechanic's tool shop by introducing the Craftsman® quick-release ratchet in 1966.



**CRAFTSMAN®**

**SEE PAGE 47 FOR THIS  
CRAFTSMAN® 255-PIECE  
MECHANIC'S TOOL SET**

\*\*CRAFTSMAN HAND TOOL FULL WARRANTY. If this Craftsman hand tool ever fails to provide complete satisfaction, it will be repaired or replaced free of charge. For warranty coverage details to obtain free repair or replacement, visit [www.craftsman.com](http://www.craftsman.com). This warranty gives you specific legal rights, and you may also have other rights which vary from state to state. Sears Brands Management Corporation, Hoffman Estates, IL 60179.



# tools

"I never start a job without a complete set of tools, because I know the one that I'm missing is bound to be the one I need. With Sears' incredible selection of mechanic's tool sets I know I'll be able to find the perfect complete set, whether I choose one of their many assembled sets or customize a set to my own needs. And the Sears Blue Tool Crew is always there to guide me to the best tool value."

**CHRIS DUKE**  
host of  
MOTORZ TV



# mechanic's tools



SNAP THIS CODE WITH YOUR MOBILE DEVICE AND SEE A VIDEO ON CHRIS DUKE



### A. Craftsman 154-Piece Mechanic's Tool Set with Case

- Set includes 93 sockets, three ratchets, two extension bars, 12 combination wrenches, and 44 specialty tools.
- Separate prices total \$467.85. Lifetime Warranty.\* Wt. 18.81 lbs.

009-35154 149.99

[Get the Latest Price Online](#)

### P Personalized

009-33154 189.99

[Get the Latest Price Online](#)



### MECHANIC'S TOOLS

SEE PAGES 44-65



[Personalize it!](#)



### AUTOMOTIVE SPECIALTY

SEE PAGES 66-75



### AIR DRIVE TOOLS

SEE PAGES 76-85

\*Warranted, see page 112.  
P Personalized, see page 112.





### Tina Stull

"When I need to do some work on the old pickup, it's great to have all that's available in this Universal Mechanic's Tool Set."

Learn more about Tina at [sears.com/shoptools](http://sears.com/shoptools)

Craftsman® hand tools guaranteed for life\*



SNAP THIS CODE WITH YOUR MOBILE DEVICE AND SEE A VIDEO ON THIS CRAFTSMAN® UNIVERSAL MECHANIC'S TOOL SET



#### A. Craftsman® 56-Piece Universal Mechanic's Tool Set

- 3/8-in. drive set includes 9 inch and 9 metric socket sizes, ratchet, 7 inch and 7 metric wrenches, 3-in. extension bar, magnetic bit handle, 10 screwdriver bits, and 11 inch hex keys.
- Lifetime Warranty.\* Wt. 9.83 lbs.

009-24964 99.99

[Get the Latest Price Online](#)

3/8-Inch Drive Universal Ratchet 009-24967 Wt. 1.2 lbs. 19.99

[Get the Latest Price Online](#)

# CRAFTSMAN®

# 13 must have tools for innov

## CRANK UP THE POWER...WITH

B



turn your 3/8 ratchet into a universal ratchet

#### B. Craftsman 9-Piece Inch Universal Socket Accessory Set

- Socket sizes: 1/4 thru 3/4 in.
- Compatible with any Craftsman 3/8-in. drive ratchet. Wt. 1.67 lbs.

009-24959 14.99

[Get the Latest Price Online](#)

#### 9-Piece Metric Set

- 8 thru 11, 13, 14, 16 thru 18 mm.

009-02496 Wt. 1.67 lbs. 14.99

[Get the Latest Price Online](#)

#### C. Craftsman 19-Piece Inch and Metric Universal Socket Wrench Set

- Quick-release ratchet.
- Inch sizes: 1/4 thru 3/4-in.
- Metric sizes: 8 thru 11, 13, 14, 16 thru 18 mm.
- Lifetime Warranty.\* Wt. 2.73 lbs.

009-24963 34.99

[Get the Latest Price Online](#)

#### 3/8-Inch Drive Universal Ratchet

009-24967 Wt. 1.2 lbs. 19.99

[Get the Latest Price Online](#)



#### D. Craftsman 7-Piece Inch Universal Combination Wrench Set

- Reinforced open end reduces tip spread.
- Sizes include: 5/16 thru 11/16 in.
- Lifetime Warranty.\* Wt. 2.97 lbs.

009-14018 24.99

[Get the Latest Price Online](#)

#### 7-Piece Metric Set 10 thru 15, 17 mm.

009-14019 Wt. 2.97 lbs. 24.99

[Get the Latest Price Online](#)





wrenches and sockets tackle multiple fasteners even stripped bolts



the mechanic Look for more throughout these pages

# novation

THE UNIVERSAL COLLECTION!

15 degree angled head for knuckle clearance



are

**E. Craftsman 7-Piece Inch Universal Ratcheting Wrench Set**  
 • The speed of a ratcheting box end plus the innovation of Universal design.  
 • Sizes include: 5/16 thru 11/16 in.  
 • Lifetime Warranty.\* Wt. 2.5 lbs.  
 009-21028

**Get the Latest Price Online** 49.99

**7-Piece Metric Universal Ratcheting Wrench Set** 10 thru 15, 17 mm.  
 009-21030 Wt. 2.5 lbs.  
 49.99

**Get the Latest Price Online**

\*Warranted, see page 112.

clear etched size ID quickly find the tool



SNAP THIS CODE WITH YOUR MOBILE DEVICE AND SEE A VIDEO ON THIS CRAFTSMAN® UNIVERSAL RATCHET



**SEE VIDEO**  
 at sears.com/sheertools





A



**80 SPECIALTY TOOLS INCLUDED**

**540-PIECE PROFESSIONAL SET  
OVER \$2,992 VALUE**

A. Craftsman® 540-Piece Professional Mechanic's Tool Set

- Extensive set of sockets, 119 assorted wrenches, including 16 full polish reversible ratcheting wrenches, 25 screwdrivers and 14 nut drivers.
- Separate prices total \$2,992.86. Lifetime Warranty.\* Wt. 93 lbs.

009-36540 Set 1,299.99

**Get the Latest Price Online**

# CUSTOMIZED SETS

for the professional mechanic's specific needs

**14 T-HANDLE NUT DRIVERS INCLUDED**

**427-PIECE PROFESSIONAL SET  
OVER \$2,076 VALUE**

Catalog/Online EXCLUSIVE

B. Craftsman 427-Piece Professional Mechanic's Tool Set

- 14 T-handle nut drivers, 97 assorted wrenches, including 16 ratcheting wrenches.
- Also includes 235 sockets and 16 screwdrivers.
- Separate prices total \$2,076.34. Lifetime Warranty.\* Wt. 67.5 lbs.

009-83082 Set 799.99

**Get the Latest Price Online**





Catalog/Online EXCLUSIVE  
**C. Craftsman  
 413-Piece Professional  
 Mechanic's Tool Set**

- Includes 21 1/4-in., 22 3/8-in., and 19 1/2-in. deep sockets, plus a complete assortment of hex, Torx® and screwdriver bit sockets.
- Also includes 55 combination wrenches and 14 nut drivers.
- Separate prices total \$1,907.62. Lifetime Warranty.\* Wt. 75 lbs.

009-33413 599.99

**Get the Latest  
 Price Online**

**P Personalized**

009-36413 699.99

**Get the Latest  
 Price Online**



**271 SOCKETS  
 INCLUDED**

**413-PIECE PROFESSIONAL SET  
 OVER \$1,907 VALUE**

**TOOL COUNT BREAKDOWN FOR MTS SETS**

Component Description	A. 540-Pc.	B. 427-Pc.	C. 413-Pc.	D. 255-Pc.
1/4-in. sq. drive sockets	76	76	65	54
1/4-in. drive tools	10	9	7	5
3/8-in. sq. drive sockets	134	93	114	74
3/8-in. drive tools	10	8	8	8
1/2-in. sq. drive sockets	102	66	92	22
1/2-in. drive tools	7	6	5	2
wrenches	121	97	55	28
specialty tools	80	72	67	62
<b>Catalog Number</b>	<b>009-36540</b>	<b>009-83082</b>	<b>009-33413</b>	<b>009-35255</b>
<b>Separate Prices Total</b>	<b>\$2,992.86</b>	<b>2,076.34</b>	<b>1,907.62</b>	<b>730.76</b>
<b>Price</b>	<b>\$1,299.99</b>	<b>799.99</b>	<b>599.99</b>	<b>299.99</b>

**Get the Latest Price Online**

For complete set details, go online to [sears.com](http://sears.com)



**STORAGE CHEST  
 INCLUDED**

**255-PIECE SET  
 OVER \$730 VALUE**

**D. Craftsman 255-Piece  
 Mechanic's Tool Set  
 with Lift-Top  
 Storage Chest**

- Includes 1/4, 3/8, and 1/2-in. drives with 150 sockets, 3 quick-release ratchets, and 4 extension bars.
- Also includes 28 wrenches up to 3/4-in. and 17-mm sizes, and 62 specialty tools.
- Chest features lid area storage with three pull-out drawers.
- Separate prices total \$730.76. Lifetime Warranty.\* Wt. 40.06 lbs.

009-35255 299.99

**Get the Latest  
 Price Online**



mechanic's tools

\*Warranted, see page 112.  
 P Personalized, see page 112.



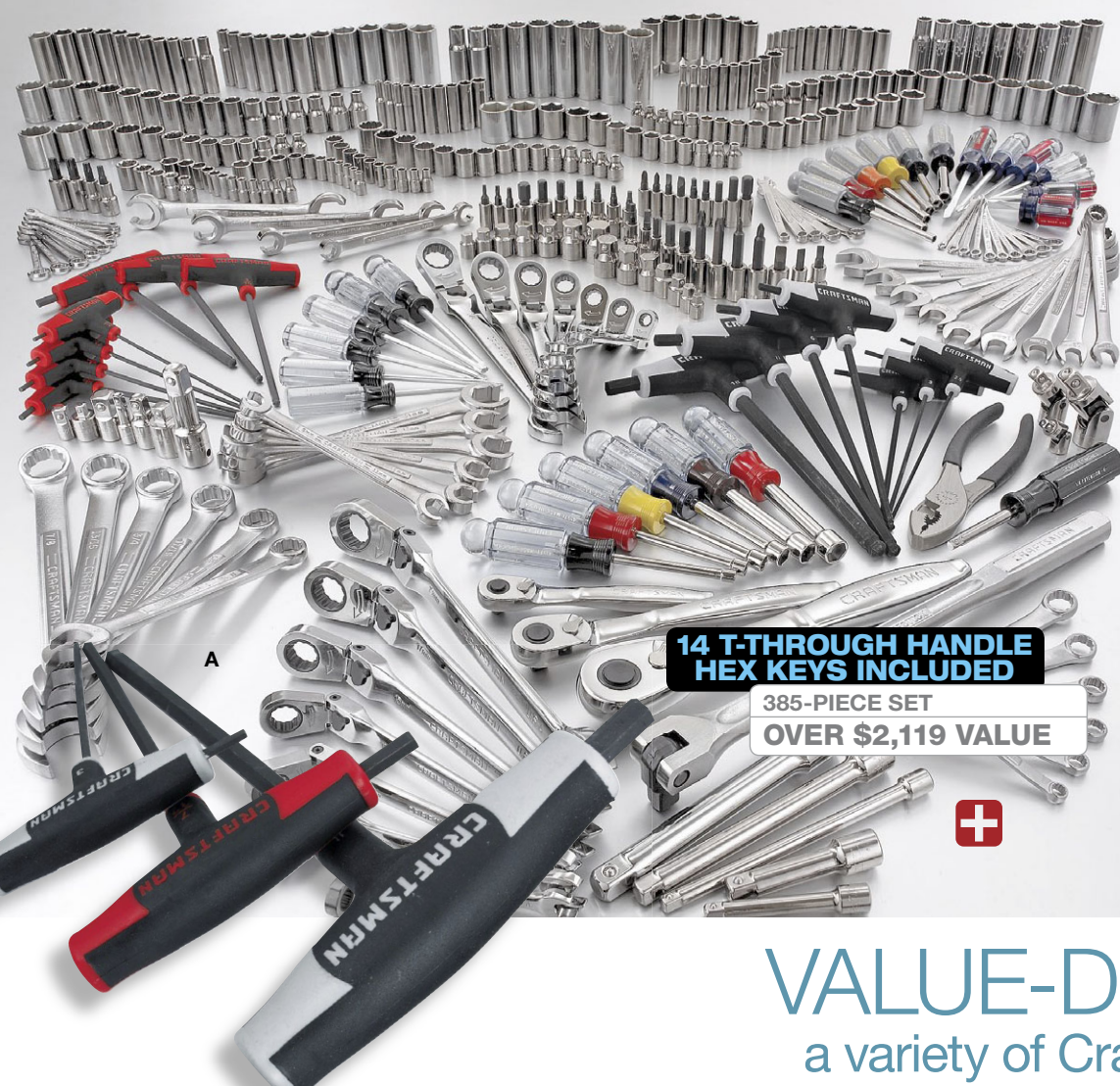

Catalog/Online EXCLUSIVE  
**A. Craftsman® 385-Piece Mechanic's Tool Set with 14 T-Through Handle Hex Keys**

- Wrench styles include combination, flex ratcheting, flare nut and ignition.
- Full-polish thin-profile ratchets and more.
- Separate prices total \$2,119.55. Lifetime Warranty.\* Wt. 76.2 lbs.

009-83076  
**Get the Latest Price Online**

949.99



**14 T-THROUGH HANDLE  
 HEX KEYS INCLUDED**

**385-PIECE SET  
 OVER \$2,119 VALUE**



**VALUE-DRIVEN & T**  
 a variety of Craftsman® mechan

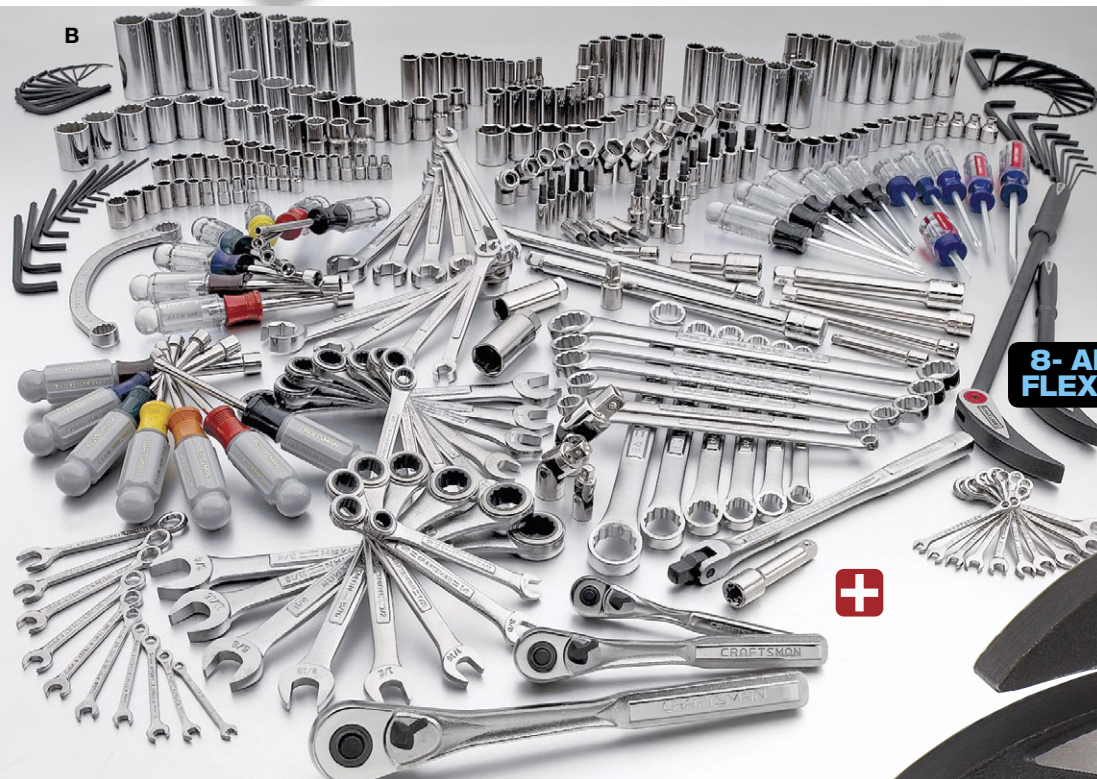

**B. Craftsman 312-Piece Mechanic's Tool Set with 8- and 16-Inch Locking Flex Pry Bars**

- Set includes 168 sockets, 10 extension bars, 16 ratcheting wrenches, 12 box end wrenches, 10 flare nut wrenches, 14 nut drivers, 12 screwdrivers and more.
- Separate prices total \$1,581.14. Lifetime Warranty.\* Wt. 48.4 lbs.

009-87622 699.99

**Get the Latest Price Online**

**8- AND 16-INCH LOCKING  
 FLEX PRY BARS INCLUDED**

**312-PIECE SET  
 OVER \$1,581 VALUE**





**C. Craftsman 309-Piece Mechanic's Tool Set**

- 15 hex bit inch and metric sockets; 42 wrenches up to 7/8-in. and 19 mm sizes.
- 1/4, 3/8, and 1/2-inch drives. 196 sockets, 3 quick-release ratchets, 5 extension bars, and 63 specialty tools.
- Separate prices total \$1,039.07. Lifetime Warranty.\* Wt. 32 lbs.

009-35309 399.99

**Get the Latest Price Online**

**COMPLETE SAE & METRIC**

**309-PIECE SET**

**OVER \$1,039 VALUE**

mechanic's tools

e

**Chris Duke**

"This complete set of Metric and SAE sockets and wrenches is all you'll ever need. Never start a job without a complete set."

Learn more about Chris at [sears.com/shoptools](http://sears.com/shoptools)

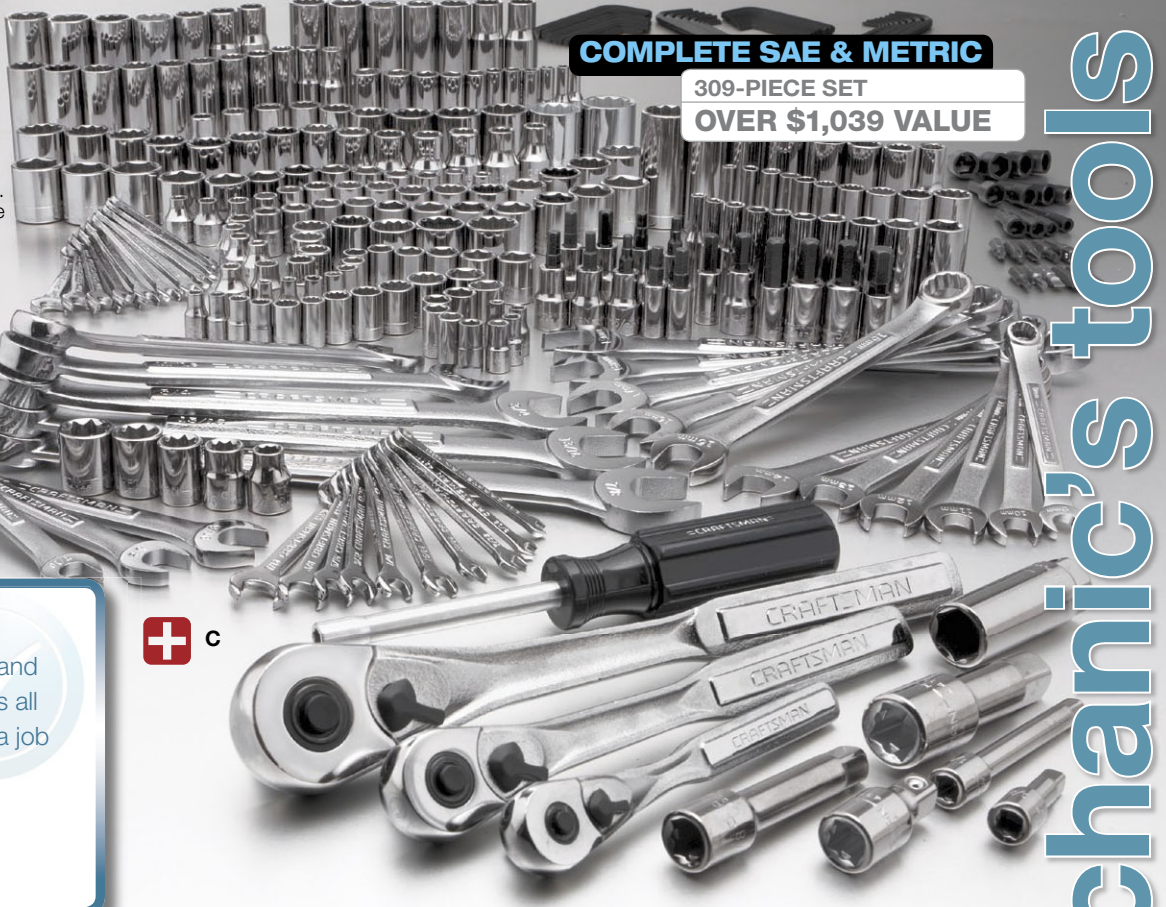

**TAILORED FOR YOU**  
ic's tool sets to match your needs

**TOOL COUNT BREAKDOWN FOR MTS SETS**

Component Description	A. 385-Pc.	B. 312-Pc.	C. 309-Pc.	D. 273-Pc. all Inch	273-Pc. all Metric
1/4-in. sq. drive sockets	76	63	69	31	23
1/4-in. drive tools	7	5	3	11	11
3/8-in. sq. drive sockets	112	73	88	53	56
3/8-in. drive tools	7	7	3	11	11
1/2-in. sq. drive sockets	52	32	39	69	74
1/2-in. drive tools	6	5	2	10	10
wrenches	84	59	42	38	38
specialty tools	41	68	63	50	50
<b>Catalog Number</b>	<b>009-83076</b>	<b>009-87622</b>	<b>009-35309</b>	<b>009-83087</b>	<b>009-83091</b>
<b>Separate Prices Total</b>	<b>\$2,119.55</b>	<b>1,581.14</b>	<b>1,039.97</b>	<b>1,606.15</b>	<b>1,611.65</b>
<b>Price</b>	<b>949.99</b>	<b>699.99</b>	<b>399.99</b>	<b>699.99</b>	<b>699.99</b>

**Get the Latest Price Online**

For complete set details, go online to [sears.com](http://sears.com)

**CHOOSE ALL SAE OR ALL METRIC**

Catalog/Online EXCLUSIVE

**D. Craftsman 273-Piece All-Inch Mechanic's Tool Set**

- Features 24 1/2-inch drive impact sockets.
- Separate prices total \$1,606.15. Lifetime Warranty.\* Wt. 62 lbs.

009-83087 699.99

**Get the Latest Price Online**

**273-Piece All-Metric Mechanic's Tool Set**

- Separate prices total \$1,611.65.
- 009-83091 Wt. 62 lbs. 699.99

**Get the Latest Price Online**

**24 IMPACT SOCKETS INCLUDED**

**273-PIECE SET OVER \$1,606 VALUE**

**CRAFTSMAN®**



latest price online

\*Warranted, see page 112.

**Get the Latest Price. [sears.com/shoptools](http://sears.com/shoptools)**



# CHOOSE THE SET THAT

mechanic's tool sets that step up to wh

**60 WRENCHES**

**348-PIECE**

**OVER \$1,443 VALUE**



A

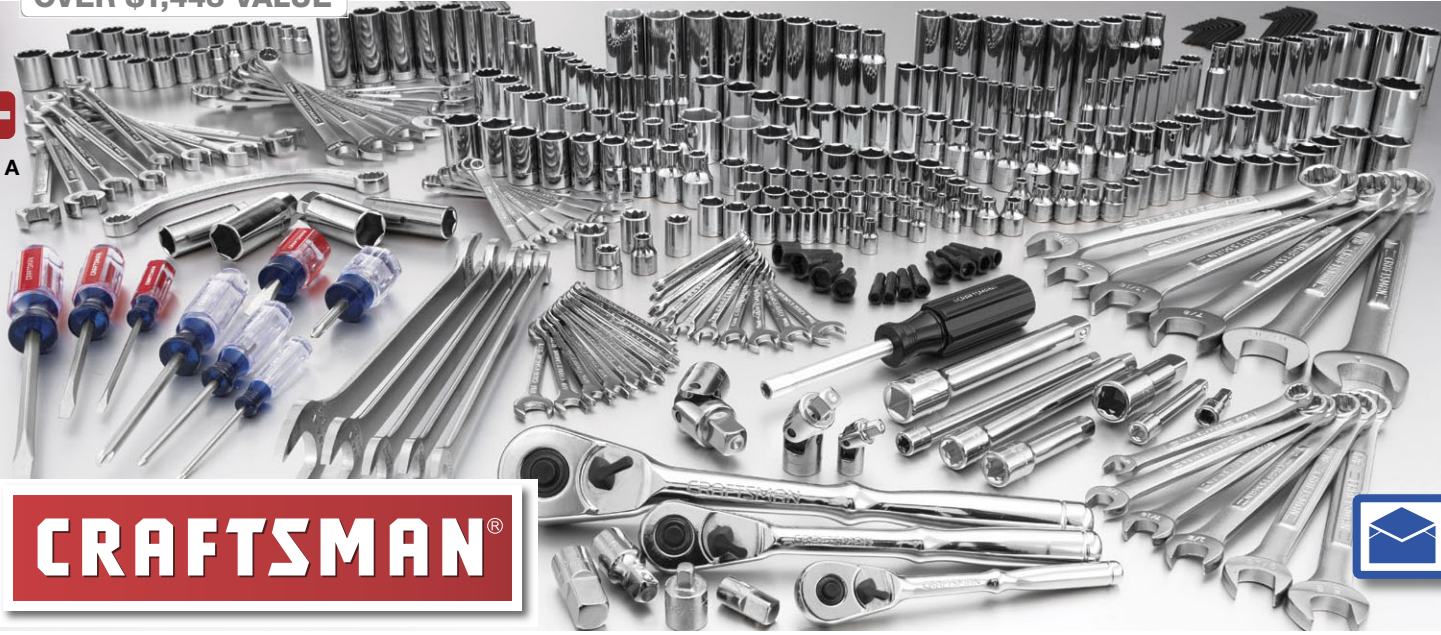

**A. Craftsman® 348-Piece Mechanic's Tool Set**

- 17 drive tools including three thin-profile ratchets.
- Set comes with 46 combination, eight flare nut, one obstruction and five tappet wrenches.
- Separate prices total \$1,443.59. Lifetime Warranty.\* Wt. 49 lbs.

009-34348 599.99  
**Get the Latest Price Online**

**B. Craftsman 283-Piece Mechanic's Tool Set with Storage**

- Craftsman steel tool chest has plastic tray inserts for easy tool organization; trays are labeled for easy tool identification.
- Separate prices total \$959.33. Made in USA. Lifetime Warranty.\* Wt. 54.4 lbs.

009-35283 399.99  
**Get the Latest Price Online**

**C. Craftsman 200-Piece Mechanic's Tool Set with Molded Carry Case**

- Includes 1/4, 3/8 and 1/2-in. drives with 128 sockets, 3 quick-release ratchets, and one extension bar.
- 6 wrenches, 62 specialty tools, and case.
- Separate prices total \$670.24. Lifetime Warranty.\* Wt. 20.4 lbs.

009-33200 199.99  
**Get the Latest Price Online**

**D. Craftsman 192-Piece Mechanic's Tool Set with Tri-Fold Case**

- 108 sockets, 3 quick-release ratchets, and 3 extension bars.
- Set also includes 16 wrenches and 62 specialty tools.
- Case separates inch and metric sizes.
- Separate prices total \$559.75. Lifetime Warranty.\* Wt. 21.5 lbs.

009-33192 199.99  
**Get the Latest Price Online**

**E. Craftsman 182-Piece Mechanic's Tool Set**

- Craftsman portable chest has plastic tray inserts for easy tool organization, trays are labeled for easy tool identification.
- Separate prices total \$554.05. Lifetime Warranty.\* Wt. 29.5 lbs.

009-33182 229.99  
**Get the Latest Price Online**  
 Catalog/Online EXCLUSIVE  
**Personalized**  
 009-81271 269.99  
**Get the Latest Price Online**

**200-PIECE OVER \$670 VALUE**



**INCLUDES MOLDED CASE**



**192-PIECE OVER \$559 VALUE**

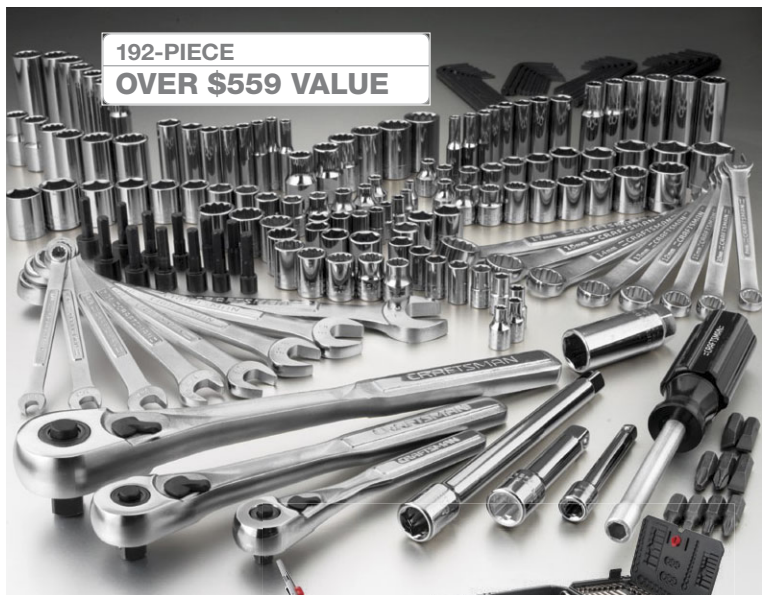

**INCLUDES TRIFOLD CASE**





# WHAT FITS YOUR NEEDS

Whatever level the project demands

**70 SPECIALTY TOOLS**

283-PIECE

OVER \$959 VALUE

Share



B

TOOL COUNT BREAKDOWN FOR MTS SETS

Component Description	A. 348-Pc.	B. 283-Pc.	C. 200-Pc.	D. 192-Pc.	E. 182-Pc.	F. 181-Pc.
1/4-in. sq. drive sockets	64	64	63	39	51	39
1/4-in. drive tools	6	4	2	2	2	2
3/8-in. sq. drive sockets	80	67	55	57	36	57
3/8-in. drive tools	7	3	1	3	3	3
1/2-in. sq. drive sockets	66	40	10	12	12	12
1/2-in. drive tools	4	2	1	1	1	1
wrenches	60	33	6	16	14	14
specialty tools	61	70	62	62	63	53
Catalog Number	009-34348	009-35283	009-33200	009-33192	009-33182	009-83049
Price	\$599.99	399.99	199.99	199.99	229.99	199.99

[Get the Latest Price Online](#)

For complete set details, go online to [sears.com](http://sears.com)

Catalog/Online EXCLUSIVE

**F. Craftsman 181-Piece Mechanic's Tool Set with Case**

- Case separates inch and metric sizes.
- Includes innovative, T-handle nut drivers and locking flex pry bars.
- Separate prices total \$662.13. Lifetime Warranty.\* Wt. 30 lbs.

009-83049 199.99

[Get the Latest Price Online](#)

Catalog/Online EXCLUSIVE

**P Personalized**

009-83227 249.99

[Get the Latest Price Online](#)

\*Warranted, see page 112.

**P** Personalized, see page 112.

mechanic's tools



**182-PIECE  
OVER \$554 VALUE**

**P** Personalize it!



E



**181-PIECE  
OVER \$662 VALUE**



F

**INCLUDES  
TRIFOLD CASE**

[shopyourway](#) rewards join now. earn today. it's free.



**233-PIECE FIELD TECH SET  
OVER \$1,057 VALUE**

**MILITARY  
CASE WITH  
TSA-  
COMPLIANT  
LOCK**



**FIELD TECHNICIAN'S TOOL KITS**

Component Description	A. 233-Pc.	C. 145-Pc.
1/4-in. sq. drive sockets	51	43
1/4-in. drive tools	8	6
3/8-in. sq. drive sockets	58	23
3/8-in. drive tools	7	5
wrenches	39	36
pliers	10	5
screwdrivers	8	8
specialty tools	52	19
Catalog Number	009-34233	009-41203
Price	\$499.99	299.99

**Get the Latest Price Online**

For more details on Field Tech Tool Kits, go online to [sears.com](http://sears.com)

# SPECIALTY FIELD TECH SETS FOR ON-THE-GO and sturdy travel cases to carry them in

Catalog/Online EXCLUSIVE  
**A. Craftsman® 233-Piece Deluxe Field Technician's Tool Set**  
• Separate prices total \$1,057.69.  
Lifetime Warranty.\* Wt. 30.4 lbs.  
009-34233 499.99

**Get the Latest Price Online**

Catalog/Online EXCLUSIVE  
**B. Craftsman Military-Ready Cart with TSA-Compliant Lock**  
• Recessed 38 1/2-in. telescoping handle with one-touch release.  
• Wraparound bumpers to absorb shocks.  
• Measures 18W x 15D x 12H in. Wt. 15 lbs.  
009-59780 279.99

**Get the Latest Price Online**

Catalog/Online EXCLUSIVE  
**C. Craftsman 145-Piece Field Technician's Tool Set**  
• Separate prices total \$603.96.  
Lifetime Warranty.\* Wt. 17 lbs.  
009-41203 299.99

**Get the Latest Price Online**

Catalog/Online EXCLUSIVE  
**D. Thermoplastic Attaché Case for "C"**  
• Reinforced corners; two removable pallets.  
• Measures 18W x 13D x 6H in. Tools not included. Wt. 11 lbs.  
009-65001 119.99

**Get the Latest Price Online**



## THERMOPLASTIC ATTACHÉ CASE WITH REMOVABLE PALLETS

**145-PIECE FIELD TECH SET  
OVER \$603 VALUE**



\*Warranted, see page 112.  
Personalized, see page 112.



# 207-PIECE SET FEATURES ALL 6-POINT WRENCHES, NUT DRIVERS AND SOCKETS FOR A SECURE GRIP ON FASTENERS

mechanic's tools

E 



**22 IMPACT SOCKETS INCLUDED**

**207-PIECE 6-PT. DUAL-MARK SET  
OVER \$1,209 VALUE**

Catalog/Online EXCLUSIVE  
**E. Craftsman 207-Piece 6-Point Mechanic's Tool Set with Dual-Mark Sockets**  
 • Features all 6-pt. sockets and 6-pt. wrenches.  
 • Separate prices total \$1209.13. Lifetime Warranty.\* Wt. 37.5 lbs.  
 009-33207 299.99  
**Get the Latest Price Online**

**F. Craftsman 94-Piece Dual-Mark Mechanic's Tool Set with Case**  
 • 2 quick-release ratchets.  
 • 22 screwdriver and nut driver bits; 14 hex keys. Lifetime Warranty.\* Wt. 9.13 lbs.  
 009-37094 79.99  
 Catalog/Online EXCLUSIVE  
 **Personalized** 99.99  
 009-80852 **Get the Latest Price Online**

**G. Craftsman 42-Piece Tool Set, Zipper Case**  
 • Includes 18 1/4-in. and 15 3/8-in. metric/inch sockets, 2 wrenches and hex key set. Lifetime Warranty.\* Wt. 4.3 lbs.  
 009-33042 29.99  
 Catalog/Online EXCLUSIVE  
 **Personalized** 49.99  
 009-80853 **Get the Latest Price Online**

**TOOL COUNT BREAKDOWN FOR MTS SETS**

Component Description	Mechanic's E. 207-Pc.	Dual Mark Mechanic's F. 94-Pc.
1/4-in. sq. drive sockets	44	32
1/4-in. drive tools	2	1
3/8-in. sq. drive sockets	52	20
3/8-in. drive tools	3	2
1/2-in. sq. drive sockets	68	0
1/2-in. drive tools	2	0
wrenches	26	2
specialty tools	10	37
<b>Catalog Number</b>	<b>009-33207</b>	<b>009-37094</b>
<b>Price</b>	<b>\$299.99</b>	<b>79.99</b>

**Get the Latest Price Online**

For complete set details, go online to sears.com

**94-PIECE 6-PT. DUAL-MARK SET  
OVER \$250 VALUE**





 **Personalize it!**



**INCLUDES CASE**

**42-PIECE TOOL SET  
OVER \$103 VALUE**



 **Personalize it!**

**INCLUDES CASE**

shopyourway rewards join now. earn today. it's free.



# MODULE 1

## A. 300-PIECE STARTER SET

- 168 sockets
- 19 drive tools
- 53 wrenches
- 6 screwdrivers
- 54 specialty tools

A. Craftsman®  
300-Piece Starter Set,  
Module 1  
• Separate prices total  
\$1,502.28.† Lifetime  
Warranty.\* Wt. 60.5 lbs.  
009-33300  
**Get the Latest  
Price Online**

**649.99**  
†SAVE 56%

## CHOOSE FROM MODULES 1-11... THE SETS THE PROS USE

MODULES 1 AND 2  
COMBINED  
498-Piece Professional  
Tool Set Modules 1 & 2  
Combined  
Contains tools to cover  
most essential applications.  
Separate prices total  
\$2,842.17. Lifetime  
Warranty.\* Wt. 111.4 lbs.  
009-33498 Set 1,299.98  
**Get the Latest Price Online**



# MODULE 2

## B. 198-PIECE EXPANSION SET

- 84 sockets
- 8 drive tools
- 60 wrenches
- 9 screwdrivers
- 37 specialty tools

B. Craftsman  
198-Piece Expansion Set,  
Module 2  
• Separate prices total  
\$1,339.89.† Lifetime  
Warranty.\* Wt. 50.9 lbs.  
009-33198  
**Get the Latest Price Online**

**699.99**  
†SAVE 47%



# THE MORE YOU BUY THE

Complete modules for the dedicated student, home mechanic or professional. Get affordable financing and a lifetime guarantee\* and more.

# MODULE 5

## E. 106-PIECE ADVANCED SET

- 9 drive tools
- 56 wrenches (53 full polish)
- 22 professional screwdrivers
- 19 specialty tools

E. Craftsman  
106-Piece Advanced  
Set, Module 5  
• Separate prices total  
\$1,340.20.† Lifetime  
Warranty.\* Wt. 51 lbs.  
009-35106  
**Get the Latest  
Price Online**

**899.99**  
†SAVE 32%

## FINANCING AVAILABLE FOR THESE PROFESSIONAL MECHANIC'S TOOL SETS\*\*

ON PURCHASES OVER \$750.  
\*\*SEE PAGE 57 FOR DETAILS.

# MODULE 6

## F. 89-PIECE ACCESS EXPANSION SET

- 11 drive tools
- 51 wrenches (47 full polish)
- 14 professional pliers
- 13 specialty tools

F. Craftsman  
89-Piece Access  
Expansion Set, Module 6  
• Separate prices total  
\$1,135.12.† Lifetime  
Warranty.\* Wt. 45 lbs.  
009-35086  
**Get the Latest Price Online**

**899.99**  
†SAVE 20%



AS LOW AS \$25 per month\*\*

MODULES 1 THRU 5  
COMBINED  
997-Piece Professional  
Tool Set Modules 1, 2, 3,  
4 & 5 Combined  
Separate prices total  
\$6,734.99. Lifetime  
Warranty.\* Wt. 265.2 lbs.  
009-35997 Set 3,799.95  
**Get the Latest Price Online**

MODULES 1 THRU 6  
COMBINED  
1,086-Piece Professional  
Tool Set Modules 1, 2, 3,  
4, 5 & 6 Combined  
Separate prices total  
\$7,870.11. Lifetime  
Warranty.\* Wt. 310.2 lbs.  
009-33091 Set 4,699.94  
**Get the Latest Price Online**



AS LOW AS \$25 per month\*\*



**MODULE 3**

**C. 189-PIECE SPECIALIZED EXPANSION SET**

- 102 sockets
- 10 drive tools
- 39 wrenches
- 5 pliers
- 14 screwdrivers
- 19 specialty tools

C. Craftsman 189-Piece Specialized Expansion Set, Module 3

• Separate prices total \$1,492.17.† Lifetime Warranty.\* Wt. 70.8 lbs. 009-35189

Get the Latest Price Online

**799.99**  
†SAVE 46%



**LIFETIME WARRANTY ON ALL CRAFTSMAN HAND TOOLS\***

**MODULES 1 THRU 3 COMBINED**  
687-Piece Professional Tool Set Modules 1, 2 & 3 Combined

Separate prices total \$4,334.34. Lifetime Warranty.\* Wt. 182.2 lbs. 009-34678 Set 2,099.97  
Get the Latest Price Online

**MODULES 1 THRU 4 COMBINED**

891-Piece Professional Tool Set Modules 1, 2, 3 & 4 Combined  
Separate prices total \$5,394.79. Lifetime Warranty.\* Wt. 214.2 lbs. 009-33891 Set 2,899.96  
Get the Latest Price Online



AS LOW AS \$22 per month\*\*

C

**MODULE 4**

**D. 204-PIECE ACCESS SET**

- 37 flex sockets
- 8 drive tools
- 67 wrenches
- 10 screwdrivers
- 82 specialty tools

D. Craftsman 204-Piece Access Set, Module 4

• Separate prices total \$1,060.45.† Lifetime Warranty.\* Wt. 32 lbs. 009-33204

Get the Latest Price Online

**799.99**  
†SAVE 24%



AS LOW AS \$22 per month\*\*

D

**MORE YOU SAVE**  
Home mechanic and professional.  
All from Craftsman® only from Sears.



mechanic's tools

**MODULE 7**

**G. 83-PIECE FULL POLISH RATCHETING SET**

- 3 drive tools
- 64 ratcheting wrenches
- 16 wrench sockets

G. Craftsman 83-Piece Full Polish Ratcheting Set, Module 7

• Separate prices total \$1,285.69.† Lifetime Warranty.\* Wt. 24.9 lbs. 009-35183

Get the Latest Price Online

**849.99**  
†SAVE 33%



**EXPAND ON YOUR SET WITH NO TOOL DUPLICATION**

**MODULES 1 THRU 7 COMBINED**  
1,169-Piece Professional Tool Set Modules 1, 2, 3, 4, 5, 6 & 7 Combined  
Separate prices total \$9,155.80. Lifetime Warranty.\* Wt. 335.1 lbs. 009-35184 Set 5,549.93  
Get the Latest Price Online

**MODULES 1 THRU 8 COMBINED**  
1,246-Piece Professional Tool Set Modules 1, 2, 3, 4, 5, 6, 7 & 8 Combined  
Separate prices total \$10,894.53. Lifetime Warranty.\* Wt. 445.1 lbs. 009-33093 Set 6,449.92  
Get the Latest Price Online



AS LOW AS \$23 per month\*\*

G

**MODULE 8**

**H. 77-PIECE LARGE HEAVY-DUTY SET**

- 39 3/4 inch drive sockets
- 7 drive tools
- 25 wrenches
- 6 specialty tools

H. Craftsman 77-Piece Large Heavy-Duty Set, Module 8

• Separate prices total \$1,738.73.† Lifetime Warranty.\* Wt. 110 lbs. 009-35079

Get the Latest Price Online

**899.99**  
†SAVE 48%



AS LOW AS \$25 per month\*\*

H

\*Warranted, see page 112.

Most recent product upgrades may not be represented in module photos.





# CUSTOMIZE, COMBINE

Choose from 11 module sets with no duplication—

## MODULE 9

### A. 92-PIECE AUTO SPECIALTY TOOL SET

- 19 brake tools
- 43 engine tools
- 13 tune-up tools
- 8 battery, hose, pipe and steering tools
- 9 specialty tools

Catalog/Online EXCLUSIVE  
A. Craftsman® 92-Piece Auto Specialty Set, Module 9

• Separate prices total \$1,149.40.† Lifetime Warranty.\* Wt. 72.5 lbs.  
009-83050

Get the Latest Price Online

**999.99**  
†SAVE 13%

MODULES 1 THRU 9 COMBINED

1,338-Piece Professional Tool Set Modules 1, 2, 3, 4, 5, 6, 7, 8 & 9

Separate prices total \$12,043.93. Lifetime Warranty.\* Wt. 517.6 lbs.  
009-93298 Set 7,449.91

Get the Latest Price Online



AS LOW AS \$27 per month\*\*

## MODULE 10

### B. 130-PIECE IMPACT SET

- 120 sockets (34 swivel sockets)
- 10 drive tools

B. Craftsman 130-Piece Impact Set, Module 10

• Separate prices total \$2,019.00.† Lifetime Warranty.\* Wt. 53.8 lbs.  
009-34130

Get the Latest Price Online

**1,299.99**  
†SAVE 35%

MODULES 1 THRU 10 COMBINED

1,468-Piece Professional Tool Set Modules 1, 2, 3, 4, 5, 6, 7, 8, 9 & 10

Over 1,468 pieces means you're ready to tackle almost any job. Separate prices total \$14,062.93. Lifetime Warranty.\* Wt. 571.4 lbs.  
009-93299 Set 8,749.90

Get the Latest Price Online



AS LOW AS \$35 per month\*\*

## FINANCING AVAILABLE FOR THESE PROFESSIONAL MECHANIC'S TOOL SETS\*\*

ON PURCHASES OVER \$750.  
\*\*SEE PAGE 57 FOR DETAILS.

## MODULE 11

### C. 62-PIECE INNOVATION PRO SET

- 24 wrenches
- 14 t-handle nut drivers
- 11 t-through Torx® drivers
- 3 professional pliers
- 6 specialty tools
- 4 Torx® bit sockets

Catalog/Online EXCLUSIVE

C. Craftsman 62-Piece Innovation Pro Mechanic's Tool Set, Module 11

• Features some of the latest Craftsman innovations.  
• Completes tool assortment without duplication.  
• Separate prices total \$1,143.69.† Lifetime Warranty.\* Wt. 39.3 lbs.  
009-83051

Get the Latest Price Online

**799.99**  
†SAVE 30%



AS LOW AS \$22 per month\*\*

THE PRO TOOLS 9,299 OVER VALUE

D. SAVE... Tool Set...  
• Separate... Lifetime...  
009-9348...  
Get the L...

MODU...  
D. 1,3...  
ULTIMA...

570 se...  
85 dr...  
439 w...  
22 pl...  
61 se...



# & EXPAND

get exactly what you need

# CRAFTSMAN®

mechanic's tools

**THE ULTIMATE PROFESSIONAL TOOL SET**  
**\$99.99**  
**PER \$15,000**  
**VALUE**

AS LOW AS \$250 per month\*



\$250<sup>†</sup> on this Craftsman Ultimate  
 The module prices total \$9,549.89.  
 3-yr. Warranty.\* Wt. 658 lbs.  
 18  
 Lowest Price Online

**SEE VIDEO**  
 at sears.com/shoptools

**1-11**

**1530-PIECE PROFESSIONAL TOOL SET**

- sockets **270** specialty tools
- drive tools **19** brake tools
- wrenches **43** engine tools
- pliers **13** tune-up tools
- screwdrivers **8** battery, hose, pipe and steering tools



**COMBINE ALL SETS**  
**SAVE OVER**  
**\$5000!**

get what you want with more ways to pay choose the plan that's right for you.

**extra savings plan**



**exclusive discounts when you use your Sears Card®**

Plans may not be available for all products. Minimum purchase requirements may apply. See an associate and/or sears.com for details and availability.

**save on interest plan**



**SAVE MONEY** by paying no interest if paid in full before promotion ends

Interest will be charged to your account from the purchase date if the purchase balance is not paid in full within specified promotional period or if you make a late payment. Minimum purchase required.

**IMPORTANT DEFERRED INTEREST DETAILS:**

Interest will be charged to your account from the purchase date if the purchase balance is not paid in full within the promotional period or if you make a late payment. With credit approval, for qualifying purchases made on a Sears card (Sears Commercial One® accounts excluded) Sears Home Improvement Account (SM) valid on installed sales only. Offer is only valid for consumer accounts in good standing and is subject to change without notice. May not be combined with any other promotional offer. Sears Cards: APRs up to 29.99%, but if your account has a variable APR, the APR is up to 29.99% as of 1/03/11 and may vary. Lower rates may apply. Minimum interest charge: up to \$2. An Annual Membership Fee of up to \$39 may apply. See card agreement for details. Sears cards are issued by Citibank (South Dakota), N.A. Sears Solutions cards are issued by HSBC Bank Nevada, N.A.

**NEW monthly payment plan**

**48 equal monthly payments on purchases of \$750 and above**

Subject to credit approval. Minimum purchase of \$750 required. A fixed APR of 12.99% will apply for the 48-month term and will require a monthly payment of \$26.82 per \$1,000 financed. Advertised monthly payments are based on the price of merchandise and services, after discounts and before sales tax. Sears Installment Program is provided by GE Money. Program available in-store only.

**layaway plan**

**now with 8-week and 12-week plans**

Requires down and bi-weekly payments. All fees nonrefundable. Cancellation fees apply. Not available at all Sears stores. 12-week layaway option available on purchase of more than \$400. Exclusions apply. See an associate for details.

SET COMPONENTS GO TO SEARS.COM

\*Warranted, see page 112.

Most recent product upgrades may not be represented in module photos.



# SOLUTIONS FOR YOUR MOST

Innovative features are standard



A  
+

## innovation

work around obstructions and get to those hard-to-reach nuts and bolts easily

6



## ELBOW RATCHETING

SEE VIDEO  
at sears.com/shoptools



B

## innovation

90-degree twist puts the power of your grip right where you need it

7

## CROSSFORCE™ RATCHETING



+

## innovation

thin head for tight spaces

8

## RATCHETING

C  
new

### A. Craftsman® 7-Piece Inch Elbow Ratcheting Wrench Set

- Pivoting joint gets to those hard-to-reach nuts and bolts.
- Once wrench and fastener are engaged, use a push/pull motion to quickly ratchet.
- Sizes include 3/8, 7/16, 1/2, 9/16, 5/8, 11/16, 3/4 in. Lifetime Warranty.\* Wt. 10.06 lbs.

009-14635 99.99

Get the Latest Price Online

### Metric Set

10, 11, 13 thru 15, 17, 19 mm.  
009-14636 Wt. 9.88 lbs. 99.99

Get the Latest Price Online

Catalog/Online EXCLUSIVE

### B. Craftsman 14-Piece Cross-Force™ Full Polish Reversible Ratcheting Combination Wrench Set

- Full polish Cross-Force design, now in a reversible ratcheting wrench, puts your hand on the flat portion for greater comfort.
- All 12-pt.; includes inch sizes 3/8, 7/16, 1/2, 9/16, 5/8, 11/16, 3/4 in., and metric sizes 10, 12 thru 15, 17, 18 mm.

• Lifetime Warranty.\* Separate prices total \$249.98. Wt. 6.5 lbs.  
009-47417 229.99

Get the Latest Price Online

### 7-Piece Inch Set

3/8 thru 3/4 in.  
009-44850 Wt. 3.3 lbs. 124.99

Get the Latest Price Online

### 7-Piece Metric Set

10, 12 thru 15, 17, 18 mm.  
009-44851 Wt. 3.1 lbs. 124.99

Get the Latest Price Online

### C. new Craftsman 8-Piece Inch Flat, Full Polish Ratcheting Wrench Set

- Full polish finish for easy clean-up.
- Sizes include 5/16, 3/8, 7/16, 1/2, 9/16, 5/8, 11/16, 3/4 in.

• Lifetime Warranty.\* Wt. 3.1 lbs.  
009-22984 79.99

Get the Latest Price Online

### Metric Set

8, 10, 12 thru 15, 17, 18 mm.  
009-22985 Wt. 3 lbs. 79.99

Get the Latest Price Online





# BEST CHALLENGING JOBS

with Craftsman® wrenches



mechanic's tools



## DUAL RATCHETING

**D. Craftsman 8-Piece Inch Full Polish Dual Ratcheting Wrench Set**

- Speed of a ratchet with the access of an open-end wrench.
  - 100% ratcheting on open and box ends.
  - Sizes include 5/16, 3/8, 7/16, 1/2, 9/16, 5/8, 11/16, 3/4 in. Lifetime Warranty.\* Wt. 2.56 lbs.
- 009-14755 79.99  
**Get the Latest Price Online**
- Metric Set**  
 8, 10, 12 thru 15, 17, 19 mm.  
 009-14756 Wt. 2.54 lbs. 79.99  
**Get the Latest Price Online**



## OPEN-END RATCHETING



**innovation**  
 combines speed of ratcheting with access of open-end wrenches

**E. Craftsman 4-Piece Inch Open-End Ratcheting Wrench Set**

- Combine the speed of a ratchet with the access of an open-end wrench.
  - 5/16 x 3/8, 7/16 x 1/2, 9/16 x 5/8, 11/16 x 3/4 in. Wt. 3 lbs.
- 009-21936 24.99  
**Get the Latest Price Online**
- Metric Set** 8 x 10, 13 x 14, 15 x 16, 17 x 19 mm.  
 009-21937 Wt. 3 lbs. 24.99  
**Get the Latest Price Online**



## innovation

tighten and loosen without removing wrench



## REVERSIBLE RATCHETING

**F. Craftsman 8-Piece Inch Full Polish Reversible Ratcheting Wrench Set**

- Full polish finish for easy clean-up; sizes include 5/16, 3/8, 7/16, 1/2, 9/16, 5/8, 11/16, 3/4 in. Lifetime Warranty.\* Wt. 3 lbs.
- 009-42404 99.99  
**Get the Latest Price Online**
- Metric Set**  
 8, 10, 12 thru 15, 17, 18 mm.  
 009-42405 Wt. 3 lbs.  
**Get the Latest Price Online**

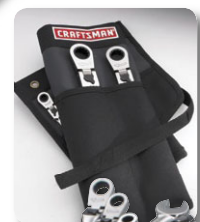

includes roll pouch



## innovation

180-degree rotating head for tight areas



## LOCKING FLEX RATCHETING

**7-Piece Inch Full Polish Locking Flex Wrench Set**

- 5/16, 3/8, 7/16, 1/2, 9/16, 5/8, 3/4 in. Lifetime Warranty.\* Wt. 3.19 lbs. 124.99
- 009-42400 Wt. 3.19 lbs. 124.99  
**Get the Latest Price Online**
- 7-Piece Metric Set**  
 8, 10, 12, 13, 15, 17, 19 mm.  
 009-42401 Wt. 3.19 lbs. 124.99  
**Get the Latest Price Online**



99.99

99.99

Catalog/Online EXCLUSIVE

**G. Craftsman 12-Piece Full Polish Locking Flex Ratcheting Wrench Set with Roll Pouch**

- 180-degree head rotation with 11 positions; locks in 9 positions.
  - Six inch sizes (3/8, 7/16, 1/2, 9/16, 5/8, 3/4 in.), and six metric sizes (8, 10, 12, 13, 15, 17 mm); includes 900-denier poly roll pouch.
  - Separate prices total \$273.38. Lifetime Warranty.\* Wt. 5.3 lbs.
- 009-83104 199.99  
**Get the Latest Price Online**

\*Warranted, see page 112.  
 ▼ Accessories/props not included.



# RELIABLE QUALITY & THE

Use expert Craftsman® wrench comb

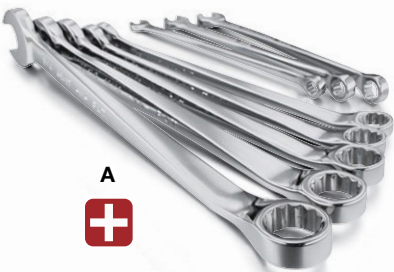

## CROSS-FORCE™ HANDLE OFFERS BETTER GRIP AND GREATER LEVERAGE

### A. Craftsman® 8-Piece Full Polish Inch Cross-Force™ Combination Wrench Set

- Sizes 5/16, 3/8, 7/16, 1/2, 9/16, 5/8, 11/16, 3/4 in.
- Separate prices total \$150.91. Lifetime Warranty.\* Wt. 3.9 lbs.

009-46520 79.99

[Get the Latest Price Online](#)

### 8-Piece Metric Set

- 8, 10, 12 thru 15, 17, 18 mm.

009-46521 Wt. 4.71 lbs. 79.99

[Get the Latest Price Online](#)

### B. Craftsman 5-Piece Full Polish Inch Cross-Force™ Combination Wrench Set

- Sizes 3/16, 7/8, 15/16, 1, 1 1/8 in.
- Separate prices total \$148.95. Lifetime Warranty.\* Wt. 8.38 lbs.

009-46527 129.99

[Get the Latest Price Online](#)

### 5-Piece Metric Set

- 19 thru 22, 24 mm.

009-46528 Wt. 6.1 lbs. 129.99

[Get the Latest Price Online](#)

Catalog/Online EXCLUSIVE

### C. Craftsman Professional® 26-Piece Full Polish Long Pattern Combination Wrench Set

- 13 inch (1/4 thru 1 in.) and 13 metric (7 thru 19 mm).
- Separate prices total \$199.98. Lifetime Warranty.\* Wt. 9.15 lbs.

009-34951 179.98

[Get the Latest Price Online](#)

### 13-Piece Inch Set

009-45963 Wt. 5.81 lbs. 99.99

[Get the Latest Price Online](#)

### 13-Piece Metric Set

009-45964 Wt. 3.5 lbs. 99.99

[Get the Latest Price Online](#)

## 12-POINT WRENCHES OFFER MORE VERSATILITY AND ACCESS



includes case

### D. Craftsman 5-Piece 12-Point Inch Combination Wrench Set

- Lengths up to 18 1/4 in.
- Inch sizes 1, 1 1/16, 1 1/8, 1 1/4, and 1 5/16 in.
- Includes blow-molded case.
- Separate prices total \$108.95. Lifetime Warranty.\* Wt. 7.4 lbs.

009-46939 64.99

[Get the Latest Price Online](#)

### 5-Piece Metric Set 22 thru 25, 30 mm.

009-46940 Wt. 5.1 lbs. 64.99

[Get the Latest Price Online](#)



### E. Craftsman 12-Piece 12-Point Inch Combination Wrench Set

- Inch sizes include 1/4 thru 7/8 in.
- Separate prices total \$96.08. Lifetime Warranty.\* Wt. 3.69 lbs.

009-47046 39.99

[Get the Latest Price Online](#)

### 12-Piece Metric Set

- 7 thru 18 mm.

009-47047 Wt. 2.81 lbs. 39.99

[Get the Latest Price Online](#)



### F. Craftsman 14-Piece 12-Point Inch Combination Wrench Set

- Includes 11/32 thru 1 1/8 in.
- Convenient carry/storage case. Lifetime Warranty.\* Wt. 7.85 lbs.

009-46933 69.99

[Get the Latest Price Online](#)

### 14-Piece Metric Set

- 009-46934 Wt. 5.84 lbs.

69.99

[Get the Latest Price Online](#)



includes case

### G. Craftsman 26-Piece 12-Point Inch Combination Wrench Set with Case

- Includes 16 sizes (1/4 thru 1 1/8 in.), and 10 ignition wrenches. Blow-molded case.
- Separate prices total \$182.03. Lifetime Warranty.\* Wt. 10.9 lbs.

009-46935 74.99

[Get the Latest Price Online](#)

### Metric Set 7 thru 22 mm.

009-46936 Wt. 8.18 lbs. 74.99

[Get the Latest Price Online](#)



includes case



### H. Craftsman 32-Piece 12-Point Combination Wrench Set

- Includes 11 inch sizes (3/8 thru 1 in.), 11 metric sizes (10 thru 20 mm), and 10 ignition wrenches (five inch, five metric).

• Includes sturdy case. Separate prices total \$222.67. Lifetime Warranty.\* Wt. 12.34 lbs.

009-46937 89.99

[Get the Latest Price Online](#)



J

### J. Craftsman 43-Piece 12-Point Combination Wrench Set

- Our largest size wrenches—up to 18 1/4 in. long.
- Includes 18 inch sizes (1/4 thru 1 5/16 in.), and 25 metric sizes (6 thru 28, 30, 32 mm).
- Separate prices total \$514.37. Lifetime Warranty.\* Wt. 25.5 lbs.

009-44048 199.99

[Get the Latest Price Online](#)





# BEST SELECTION

Tools for specialty jobs

## DEEP OFFSET FOR HARD-TO-REACH-FASTENERS



K



Catalog/Online EXCLUSIVE

### K. Craftsman Professional 12-Piece Full Polish 45-Degree Deep Offset Inch and Metric Box-End Wrench Set

• 5 inch sizes (3/8 x 7/16 thru 13/16 x 15/16 in.) and 7 metric sizes (10 x 11 thru 21 x 23 mm).

• Separate prices total \$191.98. Lifetime Warranty\* Wt. 6.06 lbs.

009-46999

79.99

[Get the Latest Price Online](#)

## REDUCES ROUNDING ON SOFT OR DAMAGED FASTENERS



L



### L. Craftsman 5-Piece Inch Flare Nut Wrench Set

• Sizes 1/4 x 5/16 thru 3/4 x 7/8 in.

• Lifetime Warranty.\* Wt. 1.31 lbs.

009-42012

39.99

[Get the Latest Price Online](#)

5-Piece Metric 9 x 11 thru 16 x 18 mm.

009-42013 Wt. 1.27 lbs.

39.99

[Get the Latest Price Online](#)

## CROWFOOT FOR TOUGH-TO-GET-TO PLACES



M



Catalog/Online EXCLUSIVE

### M. Craftsman 21-Piece Inch and Metric Crowfoot Wrench Sets

• Designed for in tough-to-get at places; use with various drive tools.

• Use with 3/8-in. drive tools.

• 11 inch sizes (3/8 thru 1 in.) and ten metric sizes (10 thru 19 mm).

• Separate prices total \$157.79. Lifetime Warranty.\* Wt. 2.4 lbs.

009-83106

89.99

[Get the Latest Price Online](#)

10-Piece Crowfoot Inch Wrench Set

3/8 thru 1 in.

009-04362 Wt. 1.25 lbs.

49.99

[Get the Latest Price Online](#)

10-Piece Crowfoot Metric Wrench Set

10 thru 19 mm.

009-04363 Wt. 0.94 lb.

49.99

[Get the Latest Price Online](#)

N. Craftsman 10-Piece Inch Fractional Crowfoot Flare Nut Wrench Set

• Use for soft or damaged fasteners in tough-to-reach spaces.

• Sizes 3/8 thru 1 in.

• Lifetime Warranty.\* Wt. 1.65 lbs.

009-42049

79.99

[Get the Latest Price Online](#)

10-Piece Metric Set 10 thru 19 mm.

009-42048 Wt. 1.65 lbs.

79.99

[Get the Latest Price Online](#)



N



### Q. new Craftsman 9-Piece Tru-Grip™ Inch Wrench Set

• Tru-Grip rubber with elevated finger grooves; smooth surface for ease of use.

• Reinforced open ends; reusable caddy case.

• All 12-pt.; inch sizes include 5/16, 11/32, 3/8, 7/16, 1/2, 9/16, 5/8, 11/16 and 3/4 in.

• Lifetime Warranty.\* Wt. 3.5 lbs.

009-23863

39.99

[Get the Latest Price Online](#)

9-Piece Metric Set

8 thru 10, 12, 13, 15 thru 18 mm.

009-23864 Wt. 3.5 lbs.

39.99

[Get the Latest Price Online](#)

P. Craftsman DOG BONE™ Inch Wrench

• Eight 6-point socket sizes in one wrench with a built-in, 8-lb. magnet; perfect for oil drain plugs or as a nut holder.

• GO-THRU swivel head allows for easy access at all angles; full polish, triple chrome-plated finish.

• Cam-Lock™ sockets eliminate stripping; chromoly steel offers strength and durability.

• 3/8 thru 13/16 in. Wt. 1.16 lbs.

009-14277

24.99

[Get the Latest Price Online](#)

DOG BONE™ Metric Wrench

12 thru 19 mm.

009-14278 Wt. 1.16 lbs. 24.99

[Get the Latest Price Online](#)



P



8 WRENCHES IN ONE

## innovation

Tru-Grip elevated finger grooves for more comfort under high torque

12



Q

new +

mechanic's tools

shopyourway rewards

join now. earn today. it's free.

\*Warranted, see page 112.



Catalog/Online EXCLUSIVE

**A. Craftsman® 299-Piece Dual-Mark Socket Set...the Ultimate Set!**

• Separate prices total \$1,600.44. Lifetime Warranty.\* Wt. 51 lbs.

009-35299 479.99

**Get the Latest Price Online**

**176-Piece Dual-Mark Socket Set**

009-34032 Wt. 13.9 lbs. 199.99

**Get the Latest Price Online**

Catalog/Online EXCLUSIVES

**ALL 6- OR 12-POINT SOCKET SETS, INCH & METRIC SIZES IN STANDARD & DEEP**

Lifetime Warranty\* for all.

**44-Piece 1/4-Inch 6-Point Socket Set**

Includes 21 inch, 23 metric. Standard & Deep. Separate prices total \$136.86.

009-34855 Wt. 2.5 lbs. 49.99

**Get the Latest Price Online**

**20-Piece 1/4-Inch 12-Point Socket Set**

All inch — 10 Standard, 10 Deep. Separate prices total \$62.80.

009-35749 Wt. 1.51 lbs. 29.99

**Get the Latest Price Online**

**52-Piece 3/8-Inch 6-Point Socket Set**

Includes 24 inch, 28 metric. Standard & Deep. Separate prices total \$235.38.

009-35747 Wt. 7.7 lbs. 89.99

**Get the Latest Price Online**

**52-Piece 3/8-Inch 12-Point Socket Set**

Includes 24 inch, 28 metric. Standard & Deep. Separate prices total \$242.66.

009-35748 Wt. 7.7 lbs. 89.99

**Get the Latest Price Online**

**49-Piece 1/2-Inch 6-Point Socket Set**

Includes 26 inch, 23 metric. Standard & Deep. Separate prices total \$334.11.

009-35745 Wt. 12.25 lbs. 149.99

**Get the Latest Price Online**

**66-Piece 1/2-Inch 12-Point Socket Set**

Includes 30 inch, 36 metric. Standard & Deep. Separate prices total \$481.04.

009-35746 Wt. 19.9 lbs. 199.99

**Get the Latest Price Online**

**63-Piece 6-Point Deep Set**

Includes 32 inch, 31 metric. Separate prices total \$384.47.

009-35743 Wt. 13.3 lbs. 179.99

**Get the Latest Price Online**

**62-Piece 12-Point Deep Set**

Includes 34 inch, 28 metric. Separate prices total \$434.38.

009-35744 Wt. 16.8 lbs. 199.99

**Get the Latest Price Online**

Catalog/Online EXCLUSIVE

**B. Craftsman 73-Piece 1/4-Inch Drive Inch/Metric Socket Wrench Set**

• 66 sockets in 6 and 12-pt. inch/metric, regular and deep.

• Also 5 inch hex bits, 7 screwdriver bits (2 slotted, 2 Phillips, 3 Torx®), 2 extension bars, quick release ratchet, universal joint, 6-in. flex T-handle, 1/4-in. flex extension and 4 1/2-in. slide bar.

• Separate prices total \$245.37. Lifetime Warranty.\* Wt. 4.63 lbs.

009-34827 99.99

**Get the Latest Price Online**

**C. Craftsman 124-Piece 3/8-Inch Drive Inch/Metric Socket Wrench Set**

• 118 sockets in 6 and 12-pt. inch/metric (regular and deep) plus 8-pt. inch sockets.

• 12 inch/metric hex bits, 13 slotted/Phillips/Torx® screwdriver bits, 2 spark plug inch sockets.

• Quick release ratchet, 3 extension bars, universal joint and 10-in. flex T-handle. Separate prices total \$528.76. Lifetime Warranty.\* Wt. 15.9 lbs.

009-81278 199.99

**Get the Latest Price Online**

# THE ULTIMATE SET—ALL 1/4, 3/8, 1/2, and 3/4-INCH

TOOL COUNT BREAKDOWN SAS FOR SETS		
Component Description	A. 299-Pc.	176-Pc.
1/4-in. sq. drive sockets	33	33
1/4-in. sq. drive deep sockets	31	21
3/8-in. sq. drive sockets	63	52
3/8-in. sq. drive deep sockets	46	32
1/2-in. sq. drive sockets	78	24
1/2-in. sq. drive deep sockets	48	14
<b>Catalog Number</b>	<b>009-35299</b>	<b>009-34032</b>
<b>Price</b>	<b>\$479.99</b>	<b>199.99</b>

**Get the Latest Price Online**

For more details on SAS sets, go online to sears.com



## ALL THE SIZES FOR 1/4, 3/8, 1/2, and 3/4-INCH



**1/4-INCH, 6- AND 12-POINT OVER \$245 VALUE**





# 3/8, 1/2-INCH SOCKETS

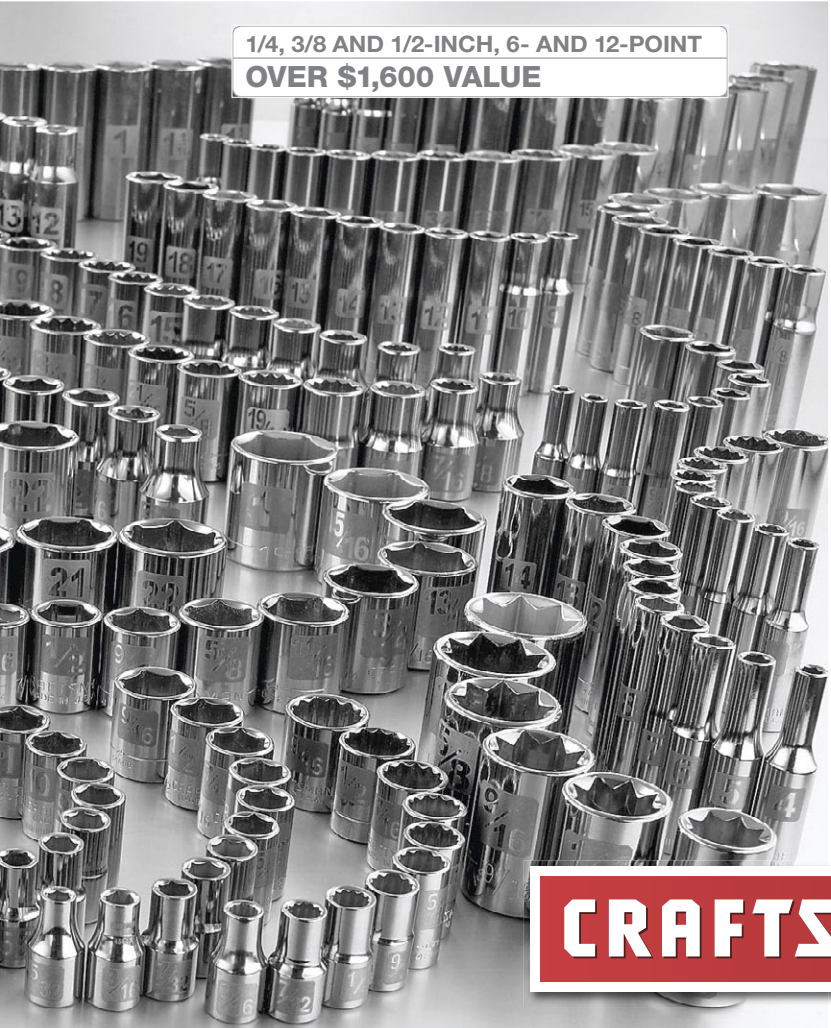

1/4, 3/8 AND 1/2-INCH, 6- AND 12-POINT  
OVER \$1,600 VALUE



3/4-INCH, 12-POINT  
OVER \$365 VALUE



## FOR ALL YOUR NEEDS

in drive sockets and sets



3/8-INCH, 6- AND 12-POINT  
OVER \$528 VALUE



1/2-INCH, 6- AND 12-POINT  
OVER \$518 VALUE

**MICROTORK® WRENCH INCLUDED**

mechanic's tools

- D. Craftsman 16-Piece 1/2-Inch Socket Wrench Set 3/4-Inch Drive with Case**
- Set includes 14 12-point socket sizes 7/8 thru 1 7/8 in.; quick release ratchet; and 8-in. extension bar.
  - Lifetime Warranty.\* Wt. 22.75 lbs.
- 009-46304 **249.99**  
[Get the Latest Price Online](#)  
 Personalized  
 009-80856 **279.99**  
[Get the Latest Price Online](#)  
 Catalog/Online EXCLUSIVE  
**24-Piece 1/2-Inch Set 7/8 thru 2 1/4 in.**  
 009-83121 Wt. 38 lbs. **299.99**  
[Get the Latest Price Online](#)  
 Personalized  
 009-83122 **329.99**  
[Get the Latest Price Online](#)  
**22-Piece Metric Set 19 thru 30, 32, 35, 36, 38, 41, 42 mm.**  
 009-83123 Wt. 28.5 lbs. **269.99**  
[Get the Latest Price Online](#)  
 Personalized  
 009-83124 **299.99**  
[Get the Latest Price Online](#)  
 Catalog/Online EXCLUSIVE  
**E. Craftsman 79-Piece 1/2-Inch Drive Inch/Metric Socket Wrench Set**
- 72 sockets in 6 and 12-pt. inch/metric, standard and deep.
  - Also 3 extension bars, 2 spark plug sockets, quick-release ratchet and torque wrench.
  - Separate prices total \$518.71. Lifetime Warranty.\* Wt. 27 lbs.
- 009-34824 **229.99**  
[Get the Latest Price Online](#)

\*Warranted, see page 112.  
 Personalized, see page 112.



**STUBBY FLEX FOR  
GETTING INTO  
OBSTRUCTED AREAS**



**LONG HANDLES  
FOR BETTER  
TORQUE AND  
LEVERAGE**

Catalog/Online EXCLUSIVE

**A. Craftsman® 2-Piece Full Polish, Extra-Long and Stubby 3/8-Inch Drive Ratchet Set**

- Includes 11-in. teardrop ratchet with raised lip to prevent accidental lever reversal.
- 5 1/2-in. stubby quick-release ratchet with short flexible handle for tight areas.
- Separate prices total \$45.98. Wt. 1.38 lbs.

009-44802 39.99

**Get the Latest Price Online**

**Stubby Quick-Release Ratchet**  
009-44834 Wt. 0.5 lb. 22.99

**Get the Latest Price Online**

**Extra-Long Teardrop Quick-Release Ratchet**  
009-44833 Wt. 0.84 lb. 28.99

**Get the Latest Price Online**



**P Personalize it!**

**FULL POLISH 3-PIECE SET  
CLEANS EASILY AND HAS A  
SHORT 10° RATCHETING ARC**

Catalog/Online EXCLUSIVE

**B. Craftsman 3-Piece Full Polish Quick-Release Ratchet Set**

- Includes teardrop ratchets in 1/4, 3/8 and 1/2-in. drive sizes.
- Separate prices total \$89.97. Wt. 2.44 lbs.

009-44803 59.99

**Get the Latest Price Online**

**Personalized**  
009-81279 79.99

**Get the Latest Price Online**

**1/4-Inch Drive**  
• 5 1/2-in. long. Wt. 0.31 lb. 22.99

**Get the Latest Price Online**

**3/8-Inch Drive**

• 7 11/16-in. long. Wt. 0.69 lb. 27.99  
009-44813

**Get the Latest Price Online**

**1/2-Inch Drive**

• 10 3/8-in. long. Wt. 1.44 lbs. 38.99  
009-44814

**Get the Latest Price Online**

**C. Craftsman 22-Degree Offset Handle Quick-Release Ratchet**

- 11 1/8-in. ratchet features pivoting 0 to 90-degree flex head and offset handle.
- 3/8-in. drive. Wt. 1.34 lbs. 30.99  
009-44835

**Get the Latest Price Online**

**22° OFFSET  
FOR MORE  
OPTIONS  
IN TIGHT  
AREAS**



**CRAFTSMAN®**

**ONE BEAUTIFUL CHOICE  
hardworking tools**



**G. Craftsman 3/8-Inch Thumbwheel Ratchet**

- Triple-tooth contact for smooth ratcheting with little movement. Wt. 0.25 lb.

009-43398 19.99

**Get the Latest Price Online**

**1/4-Inch Thumbwheel Ratchet**  
009-43397 Wt. 0.25 lb. 19.99

**Get the Latest Price Online**

Catalog/Online EXCLUSIVE

**H. Craftsman 21-Piece Drive Tool Accessory Set**

- For 1/4, 3/8 and 1/2-in. sockets.
- Set includes 13 extension bars in three drive sizes, five adapters: 1/4-in. (3/8 in.), 3/8-in. (1/4 and 1/2 in.), 1/2-in. (3/8 and 3/4 in.); three universal joints (1/4, 3/8 and 1/2 in.).
- Separate prices total \$146.29. Lifetime Warranty.\* Wt. 6.88 lbs.

009-42283 69.99

**Get the Latest Price Online**



Catalog/Online EXCLUSIVE

**J. Craftsman 4-Piece 1/2-Inch Drive Drag Link Socket Set**

- Screwdriver-type for large slotted bolts or studs; sizes 9/16, 3/4, 15/16 and 1 3/16 in.
- Separate prices total \$43.96. Lifetime Warranty.\* Wt. 0.94 lb.

009-34299 29.99

**Get the Latest Price Online**



THINNEST PROFILE  
RATCHET, COMFORT  
HANDLE AND A 6° ARC



**P** Personalize it!



**PREMIUM GRADE RATCHETS OFFER A SHORT 4 1/2° ARC AND FULLY SEALED HEAD TO KEEP OUT DIRT**

**ERGO FLEX HEAD FOR COMFORT GRIP IN TIGHT AREAS**

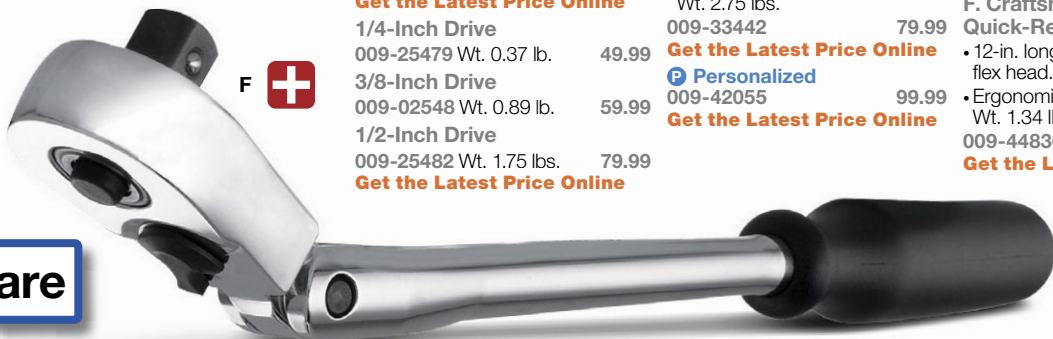

Catalog/Online EXCLUSIVE  
**D. Craftsman 3-Piece Premium Grade Ratchet Set**

- Long ergonomic handles increase torque and comfort.
- 84-tooth gear allows 4.5-degree arc swing. Lifetime Warranty.\*

009-29498 159.99  
**Get the Latest Price Online**

**1/4-Inch Drive**  
009-25479 Wt. 0.37 lb. 49.99

**3/8-Inch Drive**  
009-02548 Wt. 0.89 lb. 59.99

**1/2-Inch Drive**  
009-25482 Wt. 1.75 lbs. 79.99  
**Get the Latest Price Online**

Catalog/Online EXCLUSIVE  
**E. Craftsman Next Generation 3-Piece Full Polish, Thin Profile Ratchet Set**

- Includes 1/4, 3/8 and 1/2-in. drives.
- Separate prices total \$97.97.

009-33442 79.99

**Get the Latest Price Online**

**P Personalized**

009-42055 99.99

**Get the Latest Price Online**

**1/4-Inch Drive Thin Profile Ratchet**  
009-44994 Wt. 0.44 lb. 24.99

**3/8-Inch Drive Thin Profile Ratchet**  
009-44995 Wt. 0.75 lb. 32.99

**1/2-Inch Drive Thin Profile Ratchet**  
009-44996 Wt. 1.44 lbs. 39.99

**Get the Latest Price Online**

**F. Craftsman Ergo Flex Head Quick-Release Ratchet**

- 12-in. long with pivoting 0 to 90-degree flex head.

- Ergonomic handle; 3/8-in. drive.

009-44836 30.99  
**Get the Latest Price Online**

Share

**CHOOSE AFTER ANOTHER**  
Tools with style



Catalog/Online EXCLUSIVE

**K. Craftsman 42-Piece 1/4 & 3/8-Inch Drive Flex Socket Accessory Set**

- 1/4-in. and 3/8-in. 6-point sockets, 3/8-in. 12-point sockets
- Separate prices total \$338.58. Lifetime Warranty.\* Wt. 5.5 lbs.

009-35750

**Get the Latest Price Online**



Catalog/Online EXCLUSIVE

**L. Craftsman 50-Piece 1/4, 3/8 and 1/2-Inch Drive Bit and Torx® Super Socket Set**

- 1/4-in. and 3/8-in. drive includes external Torx® sockets, Torx® bit sockets, screw bit sockets, inch hex sockets, and metric hex sockets.
- 1/2-in. drive includes four hex bits.
- Separate prices total \$343.10. Lifetime Warranty.\*

009-35050

**Get the Latest Price Online**



**M. Craftsman 7-piece Tamper-Proof Torx® Bit Socket Set**

- Patented new pressure fit system increases bit retention and reduces bit movement in holder.
- Set includes sizes T15, T20, T25, T30, T40, T45 and T50.

009-42614 39.99

**Get the Latest Price Online**

**QUICK-RELEASE RATCHETS**

- Quick-release socket button for fast socket changes.
- Gear/pawl mechanism withstands 50% more torque than ANSI standards.



\*Warranted, see page 112.  
P Personalized, see page 112.  
▼ Accessories/props not included.

**Get the Latest Price. sears.com/shoptools**

mechanic's tools





A  
+



B  
+

Catalog/Online EXCLUSIVE

**A. Craftsman® 14-Piece T-Through Handle Ball End Hex Key Set**

- Offers the access of a ball end key, speed of a T-handle, and torque power of an L-key.
- Inch sizes: 3/32, 7/64, 1/8, 5/32, 3/16, 7/32, 1/4 in.; metric sizes: 2.5, 3, 4, 5, 6, 8, 10 mm.
- Separate prices total \$69.98. Lifetime Warranty.\* Wt. 3 lbs.

009-46380 59.99

[Get the Latest Price Online](#)

**7-Piece Standard T-Through Handle Ball End Hex Key Set**

009-46383 Wt. 1.3 lbs. 39.99

[Get the Latest Price Online](#)

**7-Piece Metric T-Through Handle Ball End Hex Key Set**

009-46384 Wt. 2.1 lbs. 39.99

[Get the Latest Price Online](#)

Catalog/Online EXCLUSIVE

**B. Craftsman 14-Piece T-Handle Nut Driver Set, Inch/Metric**

- T-handle design for additional leverage and greater torque strength.
- Sizes include: 3/16, 1/4, 5/16, 11/32, 3/8, 7/16, 1/2 in., and 5 thru 11 mm.
- Separate set prices total \$79.98. Lifetime Warranty.\* Wt. 3.5 lbs.

009-87648 59.99

[Get the Latest Price Online](#)

**7-Piece Inch T-Handle Nut Driver Set**

009-34546 Wt. 2.5 lbs. 39.99

[Get the Latest Price Online](#)

**7-Piece Metric T-Handle Nut Driver Set**

009-34547 Wt. 2.5 lbs. 39.99

[Get the Latest Price Online](#)

+



**TAMPER-PROOF TORX® TIPS ON ALL DRIVERS!**

Catalog/Online EXCLUSIVE

**C. Craftsman 11-Piece T-Through Torx® Driver Set**

- Includes: T8, T9, T10, T15, T20, T25, T27, T30, T40, T45, T50.
- Separate prices total \$64.98. Lifetime Warranty.\* Wt. 2 lbs.

009-87647 49.99

[Get the Latest Price Online](#)

**7-Piece T-Through Torx® Drivers**

009-46410 Wt. 1.19 lbs. 34.99

[Get the Latest Price Online](#)

**4-Piece T-Through Torx® Drivers**

009-46411 Wt. 1.13 lbs. 34.99

[Get the Latest Price Online](#)

+



D

**D. Craftsman 14-Piece Nut Driver Set**

- Inch sizes: 3/16 thru 1/2 in.; metric sizes: 5 thru 11 mm.
- Crafted of tough alloy steel, tools measure 6 1/2-in. long.
- Lifetime Warranty.\* Wt. 3 lbs.

009-34070 Wt. 3 lbs. 44.99

[Get the Latest Price Online](#)

**Personalized**

009-46314 64.99

[Get the Latest Price Online](#)



**Personalized**

**12-Piece Nut Driver Set**

009-34555 Wt. 3 lbs. 39.99

[Get the Latest Price Online](#)

**7-Piece Inch Nut Driver Set**

009-04196 Wt. 1.5 lbs. 29.99

[Get the Latest Price Online](#)

**7-Piece Metric Nut Driver Set**

009-04197 Wt. 1.5 lbs. 29.99

[Get the Latest Price Online](#)

+



E

Catalog/Online EXCLUSIVE

**E. Craftsman 7-Piece Standard T-Handle Ball End Hex Key Set**

- Up to 25-degree working angle for hard-to-reach fasteners.
- Size range: 3/32 thru 1/4-in. Lifetime Warranty.\* Wt. 1 lb. ▽

009-42284 24.99

[Get the Latest Price Online](#)

**7-Piece Metric Set**

009-42285 Wt. 1.75 lbs. 24.99

[Get the Latest Price Online](#)





# KEEP YOUR MOTOR RUNNING



## F. Craftsman Microtork® 1/2-Inch Drive Wrench with Deluxe Case

- Micrometer-type scales stamped into housing show inch and metric torque settings.
- Accurate to  $\pm 4$  percent, clockwise or right-handed reading greater than or equal to 20 percent of capacity.
- Measures 20 to 150 ft.lbs. in 1 ft.lb. increments. Warranted.\*

009-44595 79.99

[Get the Latest Price Online](#)

## 3/8-Inch Drive Wrench

Measures 25 to 250 in.lbs.  
009-44593 Wt. 2.25 lbs. 79.99

[Get the Latest Price Online](#)

## 3/8-Inch Drive Wrench

Measures 10 to 75 ft.lbs.  
009-44594 Wt. 2.69 lbs. 79.99

[Get the Latest Price Online](#)

## G. Craftsman Digitork® 1/2-Inch Drive Torque Wrench with Digital Readout and Deluxe Case

- Gives precise inch and metric torque settings; digital readout.
- Accurate to  $\pm 3$  percent, clockwise or right-handed reading greater or equal to 20 percent of capacity.
- Measures 25 to 250 ft.lbs. in 2 ft.lb. increments. Warranted.\*

009-44597 119.99

[Get the Latest Price Online](#)

## 3/8-Inch Drive Torque Wrench

Measures 5 to 80 ft.lbs.  
009-44596 Wt. 2.75 lbs. 119.99

[Get the Latest Price Online](#)

## H. Craftsman 1/2-Inch Electronic Torque Wrench

- Features strain gauge technology for 3% or better accuracy; large LCD display and color-coded LEDs.
- Push-button operation adjusts from 20 to 200 ft.lbs., 240 to 2,400 in.lbs. and 27.1 to 271.2 Newton-meters.
- Includes case; batteries not included. 90-day limited warranty.\* Wt. 5.2 lbs.

009-47712 249.99

[Get the Latest Price Online](#)

## 3/8-Inch Drive Electronic Torque Wrench

009-47711 Wt. 3.6 lbs. 229.99

[Get the Latest Price Online](#)



## J. Craftsman 2-Piece Gear Puller Set

- Features reversible arms and multiple settings for accessing hard-to-reach areas.
- Lifetime Warranty.\* Wt. 5.25 lbs.

009-47368

[Get the Latest Price Online](#)

64.99



FEATURES DIGITAL READOUTS



**CRAFTSMAN**®



**CRAFTSMAN**  
PROFESSIONAL



## K. Craftsman Professional® Brake Bleeder and Auto Test Kit

- Everything for performing vacuum/pressure related engine diagnostics, tune-ups, fluid transfer, evacuation and one-person brake bleeding.
- Includes adapters, tapered manifold and vacuum cap plugs, connecting tubes, master cylinder refill kit and seal kit. Wt. 4.2 lbs.

009-14005

[Get the Latest Price Online](#)

89.99

## L. Craftsman® Vacuum Pump/Brake Bleed Kit

- Includes manual, bleed/vacuum test adapter, fluid reservoir, tubing and seal kit.
- 1-year warranty.\* Wt. 2.8 lbs.

009-20930

[Get the Latest Price Online](#)

59.99

\*Warranted, see page 112.

Personalized, see page 112.

automotive specialty



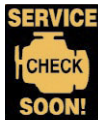

# CHECK ENGINE LIGHT ON?

It's that simple with Craftsman

## CRAFTSMAN® & INNOVA® “CHECK ENGINE” LIGHT & ABS DIAGNOSTIC TOOLS

- Each works with all 1996 and newer cars, light trucks, SUVs and minivans—foreign and domestic, including those with CAN.
- All feature a plug-and-play user interface and patented single-screen display.
- LEDs indicate if vehicle is ready to pass emissions test; automatic re-link feature helps verify repairs.
- Units turn off “Check Engine” light, clear diagnostic codes, and reset I/M monitors.

### A. Craftsman® CanOBD2 CarReader

- Save time and money by doing your own vehicle maintenance with this plug-and-play diagnostic tool.
- LEDs indicate if your vehicle is ready to pass an emissions test; turns off the “Check Engine” light; internet updateable. Wt. 1 lb.

009-14063

69.99

[Get the Latest Price Online](#)



### B. Craftsman CanOBD2 Diagnostic Tool

- Diagnose “Check Engine” light warnings on 1996 and newer vehicles, including CAN; plug-and-play interface displays over 20 values.
- Features LED display for quick emissions check.
- Retrieve/display manufacturer-specific diagnostic codes, I/M readiness status, and freeze frame data.
- USB cable; trilingual. Wt. 2.5 lbs.

009-87702

124.99

[Get the Latest Price Online](#)

### C. Craftsman CanOBD2 Scan Tool

- Designed for all 1996 and newer cars, light trucks, and SUVs—domestic, Asian and European import.
- Features backlit screen display; LED display for quick emissions check.
- View, record, playback and graph enhanced live data; perform mode 1–9 diagnostics, including VIN# ID.
- Optional RepairSolutions® for the most likely VIN-specific fix. Wt. 3 lbs.

009-20890

179.99

[Get the Latest Price Online](#)

### D. Craftsman CanOBD2 & 1 Scan Tool Kit

- For all 1996 and newer vehicles, and most 1982–95 OBD1 Ford, GM, Chrysler, Jeep, Toyota and Lexus.
- OBD2 diagnostics include enhanced live data values, OEM level DTC information and freeze frame details; retrieves diagnostic modes 1–9.
- PC software allows printable reports.
- Trilingual. Wt. 7.5 lbs.

009-20899

299.99

[Get the Latest Price Online](#)

# CRAFTSMAN®

## NOW EVERYONE CAN DIAGNOSE ALL CHECK ENGINE LIGHT PROBLEMS



F



### F. Craftsman Professional® Digital Timing Light

- For 2- and 4-cycle engines; LED tach display (0–9999 rpm) and advance display to 1/10.
- One-touch controls with precise microprocessor-controlled circuitry.
- Xenon strobe for use as flashlight while connected. Wt. 2 lbs.

009-14066

99.99

[Get the Latest Price Online](#)

### Advanced Timing Light

Analog unit.

009-14065 Wt. 2.5 lbs.

69.99

[Get the Latest Price Online](#)



G



### G. Craftsman Professional Digital Timing Light

- View and adjust base timing and overall ignition advance on conventional and DIS (distributorless) 2- and 4-cycle ignition systems.
- Serviceable leads include heat-withstanding metal pickup; fits 10-mm ignition wires.
- Uses heavy-duty battery with Dwell clamps; includes case. Wt. 3.6 lbs.

009-87701

149.99

[Get the Latest Price Online](#)

## FOUR OPERATING MODULES

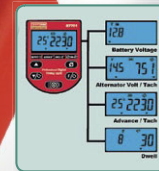



# DIAGNOSE IT YOURSELF!

Professional auto diagnostic tools



**B**  
SHOWS  
FREEZE  
FRAME  
DATA



Catalog/Online EXCLUSIVE

**E. Craftsman OBD2 Scan Tool + ABS/SRS**

- Diagnose "Check Engine" light problems on all 1996 and newer vehicles.
- Check ABS and airbag problems on most 1996 and newer GM, Ford, and Chrysler vehicles.
- Provides live data with graphing and emission status; diagnostic software. Wt. 3 lbs.

009-25488 329.99

Get the Latest Price Online



**E**



**C**  
DISPLAYS  
OBD2  
LIVE DATA



**D**  
DIAGNOSE  
OBD2 & 1  
VEHICLES



DIAGNOSE 1996 AND NEWER  
ABS & AIRBAG PROBLEMS



Share



**H**

**H. Craftsman Professional 1400-Degree Laser Infrared Thermometer with K-Type Temperature Probe**

- Measures a 1-inch spot from 13 inches.
- Laser pointer identifies target.
- Thermocouple allows surface and submerged readings.
- Displays highest, lowest, average and max-minus-min values.
- Molded housing; auto-off; 9V battery (not included).
- Measures -58°F to 1472°F. Warranted.\* Wt. 0.54 lb. •

034-81998

99.99

Get the Latest Price Online



**J**

Catalog/Online EXCLUSIVE

**J. Craftsman Professional® 1800-Degree Non-Contact Dual Laser Infrared Thermometer**

- Lasers converge to define most accurate measurement spot; measures a 1-inch spot from 30 inches; 150 millisecond response.
- Adjustable emissivity increases accuracy for different surfaces; molded housing, white backlit display, and auto off.
- Measures -58°F to 1832°F. Warranted.\* Wt. 0.4 lb. •

034-14079

179.99

Get the Latest Price Online



latest price online

\*Warranted, see page 112.

• See page 112 for laser use and precautions.

Get the Latest Price. sears.com/shoptools

automotive specialty





A 3-TON CAPACITY



A. Craftsman® 3-Ton Floor Jack, Stands, 36-Inch Creeper Combo  
 • Jack has a lift range of 5 1/2 to 19 1/4 in. and a 3-ton maximum load.  
 • Creeper has a 300-lb. maximum load. Warranted.\* Wt. 73 lbs.  
 009-50188 149.99  
 Get the Latest Price Online



# HELP WITH THE HEAVY LIFTING

Comfort designed creepers and durable lift jacks

Catalog/Online EXCLUSIVE  
 B. Craftsman Professional® Roller Creeper  
 • Four 6-in. rollers make for easy rolling, even on gravel or grass.  
 • 40-in. frame made of heavy-duty, powder-coated 1-in. steel tubing.  
 • 40L x 20W x 5H in. Wt. 26 lbs.  
 009-51168 179.99  
 Get the Latest Price Online



C. Craftsman Professional New Generation Racing Creeper  
 • 40-in. creeper has integrated steel framework covered by foam padding.  
 • Four 2 1/2-in. polyurethane inline rollers for quiet and effortless maneuvering. Wt. 20 lbs.  
 009-51150 99.99  
 Get the Latest Price Online





e

**D. Craftsman Creeper/Seat**

- 40-in. creeper turns to seat with quick-release clip.
  - 7 x 10-in. headrest provides excellent back support in the seat position.
  - 40L x 17W x 6 1/2D in. Wt. 26 lbs.
- 009-51159 89.99  
Get the Latest Price Online

**CREEPER & SEAT IN ONE****E. Craftsman Professional Aluminum 1.5-Ton Motorcycle Jack**

- Lightweight aluminum construction.
- New 3 1/2-in., low profile makes unit ideal for lifting, cleaning and moving motorcycles and ATVs.
- Locking mechanism secures vehicle at 4 levels.
- Adapter plates increase lifting range from 3 1/2 to 19 in.
- Warranted.\* Wt. 42 lbs.

009-50191

199.99

Accessories/props not included.

Get the Latest Price Online

**MOTOR CYCLE LIFTING****F. CRAFTSMAN LIGHTWEIGHT ALUMINUM****F. Craftsman Aluminum 2-Ton Capacity Floor Jack**

- Three-piece, welded aluminum arm for extra strength; ear and side frame handles for easy lifting.
- Lifting range is 3 3/4 to 18 1/2 in. Meets ANSI/ASME safety standards. Wt. 42.7 lbs.

009-50239

219.99

Get the Latest Price Online

**G. CRAFTSMAN HEAVY-DUTY STEEL****G. Craftsman 3-Ton Service Jack**

- Large heavy-duty casters with 360-degree pivot for easy positioning.
- 3-ton lifting capacity with a lifting range of 5 1/2 to 19 1/4 in.
- Includes jack, handle and manual. Wt. 73 lbs.

009-50139

89.99

Get the Latest Price Online

**H. CRAFTSMAN EXTRA-HEAVY LIFTING****H. Craftsman Professional 4-Ton Low Profile/High Lift Service Jack**

- 8,000-lb. maximum capacity and a lifting range of 4 to 20 in.
- Jack features heavy-duty chassis, overload valve system and bypass system. Wt. 101 lbs.

009-50168

189.99

Get the Latest Price Online

**ULTIMATE LIFTING FOR THE PROS****3-TON CAPACITY****J. Craftsman Professional 12-Ton Air Actuated Bottle Jack**

- One-piece base with safety valve for stable, controlled lowering.
- Range: 9 1/2 to 18 5/8 in. Wt. 26.95 lbs.

009-50332

199.99

Get the Latest Price Online

**K. Craftsman 3-Ton High Lift Jack Stands**

- Steel jack stands have a high lift range of 13 1/2 to 21 in.
- Services sport utility vehicles and automobiles.
- Set of two. Wt. 21 lbs.

009-50159

24.99

Get the Latest Price Online

**4-TON CAPACITY****L. Craftsman Professional 4-Ton Jack Stands**

- Rated capacity of 8,000 lbs. per pair.
- Ratchet design for secure adjustment; counter-weighted pawl with quick adjustment control.
- Range: 12 to 17 5/16 in. Wt. 25 lbs.

009-50163

39.99

Get the Latest Price Online

\*Warranted, see page 112.

automotive specialty



GO ONLINE TO  
SEE MORE WELDERS

CRAFTSMAN  
for MIG, arc, TIG, and

CRAFTSMAN®

A  
+



40-130  
AMP  
RANGE



B  
+

Catalog/Online EXCLUSIVE  
B. Craftsman Digital Dual  
Operation MIG Welder

- Solid state electronics, eight voltage setting and a digital interface ensures optimum gas, material and heat control.
- Unit features a turbo cooling fan, thermal overload protection and full ON/OFF safety control torch, along with an electronic spot timer for precise welding.
- 220-V primary input, 50 amp Input plug with a welding range of 30-180 amps and a 20%@160 A rated duty cycle.
- Welds up to 5/16 inch mild steel, cast iron and stainless steel. Includes 8-foot torch assembly. Wt. 101 lbs.

009-30084

1,699.99

DIGITAL  
READOUT  
CONTROL  
PANEL



A. Craftsman® Flux-Cored/MIG  
Wire Welder with Cart

- Welds mild steel — right out of the box; capable of welding aluminum, stainless steel and cast using correct wire and gas.
- Multiple power settings for welding accuracy.
- Automatic thermal overload protection.
- Fan cooled for higher performance.
- Tweco® compatible welding torch.
- Includes face shield, hammer & brush, and flux-cored wire.

009-20569

459.99

Get the Latest Price Online



# NEW WELDERS and plasma cutting



**C new**  
**35-235  
AMP  
RANGE**

Catalog/Online EXCLUSIVE

**C. new Craftsman Arc Welder**

- Ready to weld right out of the box.
- Welds mild steel, aluminum, stainless steel and cast iron (requires correct electrode).
- Includes face shield, chipping hammer & brush, electrode holder and ground clamp. Wt. 89 lbs.

009-20505 529.99

[Get the Latest Price Online](#)

**ARC WELDERS**

- Easy and versatile.
- Basic welding.
- Good for welding thicker metals.



**F new**  
**35-180  
AMP  
RANGE**

Catalog/Online EXCLUSIVE

**F. new Craftsman Wire Welder with Cart**

- Ready to Flux-Core weld right out of the box.
- Welds mild steel, aluminum, stainless steel and cast iron (requires correct wire, regulator and gas).
- Multiple voltage settings; fan cooled.
- Tweco® compatible welding torch. Wt. 59 lbs.

009-20504 599.99

[Get the Latest Price Online](#)

**MIG WELDERS**

- Wire feed.
- Create less heat.
- Weld faster.
- Less metal distortion.
- Mild steel and cast iron.



**D** **D. Arc Welder with Shunt.**

- Ready to weld
- Infinitely variable head settings
- Welds 1/16 to 3/32-in. electrodes
- Automatic thermal overload protection
- 120-V primary input, 20 amp Input plug with a welding range of 30-90 amps and a 20% @ 60 A rated duty cycle.
- Includes face shield, hammer and brush, starter pack of electrodes. Wt. 29 lbs.

009-20566 149.99

[Get the Latest Price Online](#)



**E** **E. Gasless Wire Feed Welder.**

- Welds all types of carbon steel
- Multiple settings for accurate power control.
- Infinite adjust wire speed control.
- Automatic thermal overload protection.
- Tweco® compatible welding torch.
- 120-V primary input, 20 amp Input plug with a welding range of 20-95 amps and a 20% @ 60 A rated duty cycle.
- Includes face shield, hammer and brush, flux-cored wire. Wt. 43 lbs.

009-20568 279.99

[Get the Latest Price Online](#)

Catalog/Online EXCLUSIVE

**G. Craftsman America Helmet.**

- Lightweight, balanced and durable professional welding helmet.
  - Solar filter with lithium battery assist darkens automatically to a shade #10.
  - 4.5 sq. in. viewing area.
  - Helmet meets ANSI and CUL standards. Warranted\*. Wt. 2.5 lbs.
- 009-20745 99.99

Catalog/Online EXCLUSIVE

**H and J. Craftsman Essential Welding Helmets.**

- Durable basics.
- With various viewing area options.
- Helmets meet ANSI and CUL standards. Warranted\*.

**H. Fixed-Front Helmet.**

2 x 4 1/4 in. Wt. 2.5 lbs.

009-20653 19.99

**J. Lift-Front Helmet.**

2 x 4 1/4 in. Wt. 2.5 lbs.

009-20655 24.99



**SEE MORE  
CRAFTSMAN  
AMERICA  
WELDING  
HELMET  
STYLES ONLINE**



[Get the Latest Price. sears.com/shoptools](#)

automotive specialty

ACCESSORIES ONLINE



Catalog/Online EXCLUSIVE

**A. Craftsman®  
107-Piece Carbon  
Steel Tap and Die Set**

•Wt. 18.6 lbs.  
009-52386 299.99

**Get the Latest  
Price Online**

**75-Piece Carbon Steel  
Tap and Die Set**

Wt. 9.5 lbs  
009-52377 199.99

**Get the Latest  
Price Online**

**39-Piece Inch Set in  
Blow-Molded Case**

Wt. 4.25 lbs.  
009-52382 99.99

**Get the Latest  
Price Online**

**39-Piece Metric Set in  
Blow-Molded Case**

Wt. 5 lbs.  
009-52383 99.99

**Get the Latest  
Price Online**

**A. 107-PIECE  
CRAFTSMAN  
CARBON STEEL  
TAP AND DIE SET**

- 48 Inch Taps/Dies
- 46 Metric Taps/Dies
- 2 Die Stocks
- 1 T-Handle Wrench
- 2 Tap Reamer Wrenches
- 2 Thread Gauges
- 5 Screw Extractors
- 1 Screwdriver

**innovation**

- rust-resistant finish for a smoother cut
- carbon steel surfaces make chip removal easy

13



**CRAFTSMAN®**



**75-PIECE**



**B. 75-piece  
Combination Set.**

Combines inch and metric sizes. Wt. 9.5 lbs.  
009-52377 199.99

**Get the Latest  
Price Online**

Also Available  
Craftsman 39-piece  
Sets in Blow-Molded  
Case.

Choose between inch or  
metric sizes.  
Inch. Wt. 4.25 lbs.  
009-52382 99.99

**Get the Latest  
Price Online**

Metric. Wt. 5 lbs.  
009-52383 99.99  
**Get the Latest  
Price Online**

C



**C. Craftsman Stainless  
Steel Magnetic Tray**

- Raised sides keep small tools/parts in place.
- Magnets keep bolts/screws in easy reach.
- Great for home or shop. Wt. 2 lbs.

009-41329 14.99

**Get the Latest Price Online**

D



**D. Craftsman Magnetic Steel Bowl**

- Great for shop or home; provides easy access for small tools and parts.
- Stainless steel construction. Wt. 0.4 lbs.

009-41328 9.99

**Get the Latest Price Online**



E



Catalog/Online EXCLUSIVE

**E. Craftsman 48-Piece Inch  
and Metric Master Rethreading Set**

- 6 National Course Taps, 7 National Course Dies, 6 National Fine Taps, 7 National Fine Dies, 10 Metric Taps, 10 Metric Dies
- One Inch Rethread File, 8 sizes: 11 thru 14, 16, 18, 20, 24 tpi.
- One Metric Rethread File, 8 sizes: .75, 1, 1.25, 1.5, 1.75, 2, 2.5, 3 mm tpi. Wt. 4.7 lbs.

009-42275 69.99

**Get the Latest Price Online**



F



Catalog/Online EXCLUSIVE

**F. Craftsman 4-Piece Dual Material  
Fold-Up Hex Key Set**

- Dual material grips for comfortable, non-slip grip.
- Includes 9-piece inch, 8-piece metric, 7-piece Torx® and seven-piece tamper-proof Torx hex key sets.
- Separate prices total \$52.97. Lifetime Warranty.\* Wt. 1.6 lbs.

009-46311 39.99

**Get the Latest Price Online**



Catalog/Online EXCLUSIVE

**G. Craftsman 5-Pocket Fender Cover**

- Slip-resistant vinyl cleans up easily.
- Protects finish from grime and scratches.
- Keeps tools and parts close at hand.

Wt. 1.6 lbs.  
009-51163 19.99

**Get the Latest Price Online**





**MEASURES CURRENT WITHOUT DISCONNECTING**

**WATERPROOF, DUSTPROOF & DROP-PROOF**

**INPUT COVERS PROTECT METER FROM INCORRECT TEST LEAD POSITION**

**H. Craftsman Professional® AC/DC Clamp Ammeter**  
 • Measures AC/DC current without disconnecting the circuit.  
 • Measures to 1% accuracy; also measures voltage and resistance.  
 • Includes test leads, K-type thermocouple and belt holster; UL Listed/CAT III-600V. Wt. 1.06 lbs.  
 034-73756 99.99  
[Get the Latest Price Online](#)

**J. Craftsman Professional True-RMS Multimeter**  
 • Waterproof, dustproof and drop-proof up to 6 feet.  
 • Measures voltage, current, resistance, temperature and more.  
 • Molded housing and large backlit display.  
 • Meets IP67/UL listed/CAT IV-600V; 1000V input protection. Wt. 1.5 lbs.  
 034-82003 99.99  
[Get the Latest Price Online](#)

**K. Craftsman® Multimeter**  
 • Waterproof, dustproof and drop-proof up to 6 feet.  
 • Measures voltage, current, resistance, temperature and more.  
 • Molded housing and large backlit display. Wt. 1.05 lbs.  
 034-82005 79.99  
[Get the Latest Price Online](#)

**L. Craftsman Digital Multimeter**  
 • Input covers also restrict turning of dial to incorrect position.  
 • Measures voltage, current, resistance, temperature and more.  
 • Autoranging with large LCD.  
 • Includes test leads and temperature probe. UL listed.  
 Wt. 0.85 lb.  
 034-82175 59.99  
[Get the Latest Price Online](#)

# TESTING MAKES THE GRADE SMART AND SIMPLE

## 80 SUPER BRIGHT LED LIGHTS



**M. Craftsman 80-LED Rechargeable Folding Work Light**  
 • 80 Super Bright long-life LED lights with 3-way rocker switch for 2-level lighting.  
 • Reflective strips; adjustable hinge and hook.  
 • Two powerful magnets secure to most metals. Wt. 2.5 lbs.  
 034-73950 49.99  
[Get the Latest Price Online](#)



**N. Craftsman 35-LED Work Light**  
 • Plugs in or runs up to 7 1/2 hrs. per charge.  
 • Sturdy polycarbonate lens and body.  
 • 35 bright LEDs; swivel-top hook; spotlight.  
 • Includes AC and DC chargers. Wt. 1.6 lbs.  
 034-73904 33.99  
[Get the Latest Price Online](#)



**P. Craftsman Test Instrument Kit**  
 • Auto Ranging Multimeter, laser-directed Infrared Thermometer measures from -58°F to 1000°F (-50°C to 537°C), clamp adapter measures high AC current (for use with the multimeter) and a non-contact AC voltage tester.  
 • Separate prices total \$149.96. Warranted.\* UL listed. Wt. 2.8 lbs.  
 034-82004 99.99  
[Get the Latest Price Online](#)



**Q. Craftsman Cord Reel with 26-Watt Fluorescent Work Light**  
 • Reel with 30-ft. 14/3 cord mounts to floor or ceiling.  
 • Convenience outlet; UL listed. Wt. 10 lbs.  
 034-73954 74.99  
[Get the Latest Price Online](#)

**R. Craftsman 1000W Tripod Light with Portable Stand**  
 • Quick-release extends to 70 inches tall; provides 250, 500, 750 or 1000 watts of light.  
 • Cool touch, cushioned-grip handles; two 500W bulbs; 12-ft. cord. Wt. 16.2 lbs.  
 034-73825 39.99  
[Get the Latest Price Online](#)

automotive specialty



# 80-GALLON



# 60-GALLON



## OIL-LUBE COMPRESSORS

- Ideal for professional applications.
- More durable.
- Run more quietly.



### A. Craftsman® Retractable Air Hose Reel

- Levelwind technology system automatically layers the hose evenly across the reel to ensure smooth and easy operating.
- Includes 3/8-in. x 50-ft. hose. Wt. 22.25 lbs.

009-16340  
Get the Latest Price Online



### B. Craftsman Hose Reel

- Retractable air hose reel comes with 30-ft., 300-psi hose.
- Features swivel wall mounting for 180-degree use.
- Made from high impact polypropylene. Wt. 13.1 lbs.

149.99 009-16349  
Get the Latest Price Online

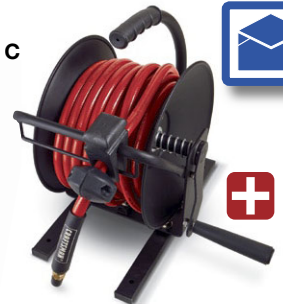

### C. Craftsman 3/8-Inch x 50-Foot Air Hose Reel

- Designed for portability; features a manual hose-layering guide to help eliminate tangles.
- Features mounting bracket, support legs and swivel. Wt. 21 lbs.

009-16347 59.99  
Get the Latest Price Online

# CRAFTSMAN®

## PROFESSIONAL

# MORE AIR FOR YOUR MONEY

amazing work

# 27-GALLON



# 25-GALLON

### CRAFTSMAN PROFESSIONAL® AIR COMPRESSORS

	Catalog Number	Description	Running HP	Tank Gal.	Volts/Phase	SCFM @ 40 PSI	SCFM @ 90 PSI	Max. PSI	Dimensions, L x W x H in.	Air NPT Outlet, in.	Weight, lbs.	Includes	Price
G.	009-16477	80-gal. 2-stage vertical tank oil lube air compressor	5.4	80	230/1	14.1 (@ 100 psi)	13.5 (@ 175 psi)	175	34.5 x 31.5 x 76.5	3/4	471	2 pre-attached air hose/air tool holders	\$1,199.99
H.	009-16476	60-gal. vertical tank oil lube air compressor	3.1	60	230/1	12.9	11.3	150	31.5 x 27.5 x 71	3/8	234	2 pre-attached air hose/air tool holders	699.99
J.	009-16474	27-gal. vertical tank oil lube air compressor	1.9	27	120/240/1	7.2	5.8	150	27 x 24 x 48.5	1/4	162	n/a	499.99
K.	009-16475	25-gal. horizontal tank oil lube air compressor	1.9	25	120/240/1	7.2	5.8	150	41.25 x 24 x 34	1/4	165	n/a	469.99

Get the Latest Price Online



Share



**D. Craftsman Heavy-Duty Air Line Filter/Regulator with Gauge**

- Features adjustable locking regulator, full flow ports and easy-to-read water indicator.
- 3/8-in. NPT input and output, and two 3/8-in. to 1/4-in. reducers.
- Rated to 175 psi. Wt. 2.25 lbs.

009-16023 **39.99**  
[Get the Latest Price Online](#)



**E. Craftsman 1/4-Inch Universal Coupler Kit**

- Quick connect and disconnect for fast air tool changes.
- Reduced wear on threaded fittings.
- Accepts industrial, automotive and ARO studs. Wt. 0.18 lb.

009-16377 **7.99**  
[Get the Latest Price Online](#)



**INCLUDES 9-PC. ACCESSORY KIT**

**12-GALLON OIL-LUBE**



**F. Craftsman 12-Gallon Vertical Oil-Lube Air Compressor**

- Takes up less space than regular horizontal air compressors.
- 125 max. psi; 2.4 scfm @ 90 psi.
- Includes 9-piece accessory kit with 25-foot coil hose.
- 18L x 20W x 1/4H in. Wt. 81 lbs.

009-16640 **199.99**  
[Get the Latest Price Online](#)



drive tools

**POWER OPTIONS**  
 ways to fix things fast



**33-GALLON**

**OIL-FREE COMPRESSORS**

- Ideal for home use.
- Lighter and more portable.
- Less maintenance.



**20-GALLON**

air

CRAFTSMAN® AIR COMPRESSORS													
	Catalog Number	Description	Running HP	Tank Gal.	Volts/Phase	SCFM @ 40 PSI	SCFM @ 90 PSI	Max. PSI	Dimensions, L x W x H in.	Air NPT Outlet, in.	Weight, lbs.	Includes	Price
L.	009-16472	33-gal. vertical tank oil-free air compressor	1.6	33	120/1	6.3	5.1	150	23.75 x 24.5 x 51	1/4	149	n/a	\$379.99
M.	009-16473	33-gal. horizontal tank oil-free air compressor	1.6	33	120/1	6.3	5.1	150	41.5 x 22.75 x 36.5	1/4	145	n/a	379.99
N.	009-16642	20-gal. vertical tank oil-free air compressor	1.5	20	120	5.1	3.8	150	22.6 x 18.5 x 43.0	1/4	90	9-pc. Accessory Kit w/ 25-ft. PVC hose	279.99
P.	009-16643	20-gal. horizontal tank oil-free air compressor	1.5	20	120	5.1	3.8	150	38.3 x 15.1 x 30.8	1/4	90	9-pc. Accessory Kit w/ 25-ft. PVC hose	279.99

[Get the Latest Price Online](#)

ACCESSORIES ONLINE



# AIR COMPRESSORS MAKE



**4-GALLON**

**6-GALLON**

**1.5-GALLON**

**4-GALLON**

CRAFTSMAN® AIR COMPRESSORS														
	Catalog Number	Description	Brand	Running HP	Tank Gal.	Volts/Phase	SCFM @ 40 PSI	SCFM @ 90 PSI	Max. PSI	Dimensions, In. L x W x H	Air NPT Outlet, in.	Weight, lbs.	Includes	Price
A.	009-16638	4-Gallon oil lube twin stack w/ detachable dolly	Craftsman	1	4	120	3.7	2.4	125	20.0 x 20.47 x 25.91	1/4	84	9-pc. Accessory Kit w/ 25-ft. PVC hose	\$179.99
B.	009-15216	6-Gallon oil-free pancake	Craftsman	0.8	6	120	3.7	2.6	150	—	1/4	44	—	169.99
C.	009-15309	1.5-Gallon portable	Craftsman	—	1.5	120	—	2.0	150	—	1/4	25	8-pc. Accessory Kit w/ 25-ft. coil hose	99.99
D.	009-15215	4-Gallon oil-free pancake	Craftsman	0.75	4	120	2.7	1.7	125	8.11 x 16.14 x 20.08	1/4	40	9-pc. Accessory Kit w/ 25-ft. PVC hose	119.99
E.	009-15310	3-Gallon horizontal oil lube	Craftsman	1	3	120	3.7	2.4	125	19.0 x 9.0 x 19.0	1/4	38	9-pc. Accessory Kit w/ 25-ft. coil hose	139.99
F.	009-16639	7-Gallon horizontal oil lube	Craftsman	1	7	120	3.7	2.4	125	28.25 x 11.25 x 24.75	1/4	70	9-pc. Accessory Kit w/ 25-ft. coil hose	169.99
G.	009-16636	5-Gallon horizontal oil lube w/ detachable dolly and telescoping handle	Craftsman	1	5	120	3.7	2.4	125	20.28 x 20.28 x 27.68	1/4	75	9-pc. Accessory Kit w/ 25-ft. coil hose	199.99

Get the Latest Price Online

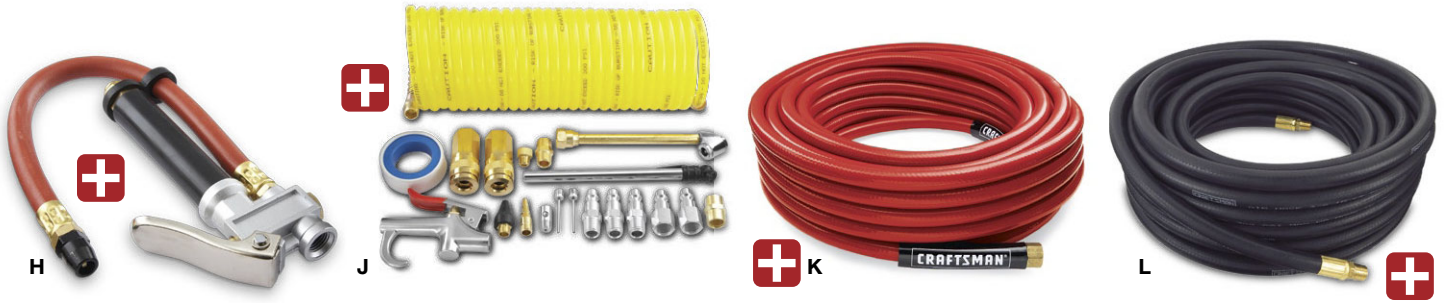

**H. Craftsman® Tire Inflator with Gauge**

- Perfect for inflating car, light truck and bicycle tires.
- In-line gauge can be read while adding air.
- 90 max. psi. Wt. 1 lb.

009-16388 **24.99**  
Get the Latest Price Online

**J. Craftsman 20-Piece Compressor Accessory Kit**

- Includes 2 NPT threaded couplers, 2 female and 3 male 1/4-in plugs, one male, one female 1/4-in. connector.
- Blow gun with safety/rubber nozzles and adaptor, 3 inflation needles, tire gauge with dual chuck, non-stick tape and 25-ft. 1/4-in. hose. Wt. 2.4 lbs.

009-16191 **24.99**  
Get the Latest Price Online

**K. Craftsman 3/8-Inch x 50-Foot Air Hose**

- Made from the highest quality reinforced PVC and virgin vinyl materials; oil/abrasion resistant.
- Solid brass, 1/4-in. NPT fittings. Wt. 4.9 lbs.

009-16110 **24.99**  
Get the Latest Price Online

**L. Craftsman 3/8-In. x 50-Foot Heavy-Duty Air Hose**

- 300 psi working pressure.
- 1200 bursting strength with 1/4-in. male/female brass fittings.
- Swivel ends. Wt. 8 lbs.

009-16113 **39.99**  
Get the Latest Price Online



# E TOUGH TASKS A BREEZE

Share



## E, F & G ACCESSORIES



M

### FRAMING NAILER



N

### FRAMING NAILER



P

### ROOFING NAILER



### FINISHING NAILER



### NAILER/STAPLER



### STAPLER



### NAILER



### U. Craftsman 3-Piece Magnesium Pneumatic Tool Kit with Storage Bag

- Magnesium bodies furnish a powerful, lightweight tool to reduce fatigue.
- Includes 16-gauge finish nailer, 18-gauge brad nailer and 18-gauge, 1/4-in. crown stapler.
- With fasteners, hose connector and heavy-duty storage bag. Wt. 11.5 lbs. 009-16853 219.99

[Get the Latest Price Online](#)

## CRAFTSMAN NAILERS AND FINISHERS

	Catalog Number	Gun Body Housing	Shank Diameter or Gauge	Tool Wt., lbs.	Adj. Depth	Fastener Range	Fasteners Included	Operating Pressure	SCFM @ 90 PSI	Case	Shipping Weight	Features	Price
M.	009-18178	Magnesium	0.113-0.131 in.	3.6	—	2 to 3 1/2 in.	—	70-110 psi	2.21	—	7.6 lbs.	Includes nailer; 4mm allen wrench; air tool oil.	\$279.99
N.	009-18179	Magnesium	0.113-0.131 in.	3.5	—	2 to 3 1/2 in.	—	70-110 psi	2.21	—	7.3 lbs.	360-degree directional exhaust; metal trigger for long-lasting durability.	279.99
P.	009-18180	Magnesium	0.12	3.6	Yes	3/4 to 1 3/4 in.	No	70-110 psi	1.05	Yes	7.6 lbs.	Magazine capacity is 120 nails, enough to secure one bundle of shingles; tool-less adjustable shingle guide	279.99
Q.	009-18175	Magnesium	16	3.4	Yes	3/4 to 2 1/2 in.	No	70-110 psi	1.41	No	6.5 lbs.	Quick-release nose; 360° exhaust	179.99
R.	009-18174	Magnesium	18 Ga. 1/4-in. Crown/18 Ga. Brad	2.6	Yes	5/8 to 1 1/2 in.	Yes	60-100 psi	0.94	Yes	6 lbs.	Quick-release nose cover to easily clear jams; drives both staples and nails; oil-less	129.99
S.	009-18170	Magnesium	20, 1/2-in. Crown	2.4	Yes	3/8 to 1 in.	Yes	60-100 psi	0.85	Yes	6.6 lbs.	1/2-in. crown staples; sequential or "bounce" fire operation; oil-less	109.99
T.	009-18172	Magnesium	18	2.6	Yes	5/8 to 2 1/8 in.	Yes	60-100 psi	0.94	Yes	6 lbs.	Sequential or "bounce" fire operation; oil-less	109.99

[Get the Latest Price Online](#)

air drive tools



1/2-INCH DRIVE



710-FT.LBS.  
OF TORQUE,  
ONLY 4.25 LBS.



TRIGGER-MOUNTED  
FORWARD/REVERSE  
AND REGULATOR FOR  
ONE-HANDED OPERATION

1/2-INCH DRIVE



4 TORQUE  
SETTINGS,  
50-400 FT.LBS.

ERGO GRIP  
FOR COMFORT



**CRAFTSMAN**

F



3/8-INCH DRIVE



1 AND  
3/4-INCH  
DRIVE



K



Craftsman® and Craftsman Professional® Impact Wrenches											
	Catalog Number	Description	Brand	Drive Size, In.	Standard Bolt Size, In.	Length, In.	Average CFM Rating	Air Inlet NPT	Max Torque, ft.lbs.	Weight, lbs.	Price
A.	009-19865	1/2-Inch Composite Impact Wrench	Craftsman Professional	1/2	9/16	7 1/8	5.0	1/4	710	4.3	\$179.99
B.	009-19905	1/2-Inch Impact Wrench	Craftsman Professional	1/2	9/16	7 1/8	3.9	1/4	600	4.5	189.99
C.	009-19986	1/2-Inch "Compact" Composite Impact Wrench	Craftsman Professional	1/2	9/16	5 7/8	4.6	1/4	500	3.5	179.99
D.	009-19984	1/2-Inch Impact Wrench	Craftsman	1/2	9/16	7	4.7	1/4	580	4.5	129.99
E.	009-19983	1/2-Inch Impact Wrench	Craftsman	1/2	1/2	7	4.5	1/4	400	5.3	89.99
F.	009-19916	3/8-Inch Impact Wrench	Craftsman Professional	3/8	7/16	5 5/8	4.0	1/4	260	2.7	189.99
G.	009-19981	3/8-Inch Impact Wrench	Craftsman	3/8	7/16	6 1/2	3.5	1/4	145	2.8	74.99
H.	009-19980	3/8-Inch Butterfly Impact Wrench	Craftsman	3/8	7/16	7 1/4	3.6	1/4	95	2.0	59.99
J.	009-19985	3/4-Inch Impact Wrench	Craftsman	3/4	1	9 1/2	5.2	3/8	750	8.0	249.99
K.	009-18507	1-Inch Extended Anvil Impact Wrench	Craftsman	1	1 1/4	20 1/2	9.5	1/2	1200	32.8	399.99
L.	009-18504	3/4-Inch Extended Anvil Impact Wrench	Craftsman	3/4	1	14 1/2	7.0	1/4	700	13.2	359.99

Get the Latest Price Online



are



COMPACT FOR TIGHT SPACES

**+**  
C



**+**  
D



SMOOTH OIL BATH HAMMER UNIT

**+**  
E



**+**  
M  
3/8-INCH DRIVE

70 FT.LBS. OF TORQUE, ONLY 2.6 LBS.



air drive tools



**+**  
N

1/4-INCH MINI

**+**  
P

**+**  
Q

**+**  
R

3/8-INCH DRIVE

# MAXIMUM POWER & CONTROL

Craftsman® & Craftsman Professional® impact & ratchet wrenches

Craftsman and Craftsman Professional Air Ratchets

	Catalog Number	Description	Brand	Drive Size, In.	Standard Bolt Size, In.	Length, In.	Average CFM Rating	Air Inlet NPT	Max Torque, ft.lbs.	Weight, lbs.	Price
M.	009-19934	3/8-Inch Ratchet Wrench	Craftsman Professional	3/8	3/8	10 1/8	4.5	1/4	70	2.6	\$99.99
N.	009-19933	3/8-Inch Ratchet	Craftsman	3/8	3/8	10	4.0	1/4	50	2.3	69.99
P.	009-19932	3/8-Inch Ratchet	Craftsman	3/8	3/8	10	4.2	1/4	45	2.5	34.99
Q.	009-19930	1/4-Inch Mini Ratchet	Craftsman	1/4	1/4	8	3.6	1/4	20	1.5	49.99
R.	009-19931	3/8-Inch Mini Ratchet	Craftsman	3/8	3/8	8	3.6	1/4	20	1.5	49.99

Get the Latest Price Online

shopyourway rewards join now. earn today. it's free.





A



## HIGH SPEED SANDER

- A. Craftsman® High Speed Sander**
- 4, 5 or 6-in. pad diameter.
  - 18,000 strokes per minute.
  - 4.3 average CFM rating; 1/4-in. air inlet NPT. Wt. 2 lbs.

009-19965 49.99

[Get the Latest Price Online](#)



B



## DUAL ACTION SANDER

- B. Craftsman Dual Action Sander**
- 10 1/2-in. length; 6-in. pad diameter.
  - 10,000 strokes per minute.
  - Dual action for swirl-free finish; 3.1 average CFM rating. Wt. 3.5 lbs.

009-19976 69.99

[Get the Latest Price Online](#)



C



## PALM SANDER

- C. Craftsman Palm Sander**
- Built-in air regulator; 6-in. pad.
  - 12,000 strokes per minute.
  - 3.1 average CFM rating; 1/4-in. air inlet NPT; vacuum ready. Wt. 2.2 lbs.

009-19960 99.99

[Get the Latest Price Online](#)



# AIR DRIVEN POWER, FAST

Craftsman® brand offers a huge selection of



## ANGLE GRINDER



## DIE GRINDER KIT

G

## STRAIGHT DIE GRINDER



## RIGHT-ANGLE DIE GRINDER



## CUT-OFF TOOL



D



## D. Craftsman Professional® Continuous Flow Grease Gun

- Heavy-duty spring-and-piston design allows self-priming and continuous flow.
- Loads three ways: 14-oz. cartridge, bulk-filled, or canister-filled.
- Balanced head design; 40:1 output ratio with 2400 to 6000 lbs. output pressure; 1.0 SCFM @ 90 psi. Warranted.\* Wt. 3.48 lbs.

009-19959 49.99

[Get the Latest Price Online](#)



Catalog/Online EXCLUSIVE

### E. Craftsman 1/4-Inch Die Grinder Kit

- 1/2-hp motor develops up to 20,000 rpm.
- Includes 7 carbide bits and case.
- Rear exhaust. Wt. 3 lbs.

009-19025 159.99

[Get the Latest Price Online](#)

### F. Craftsman 5-Inch Angle Grinder

- 3/4-hp motor provides up to 13,500 rpm.
- Accepts 4 1/2 to 5-in. grinding wheels.
- 12.0 SCFM @ 90 psi; 1/4-in. air inlet. Wt. 4.9 lbs.

009-19911 189.99

[Get the Latest Price Online](#)

### G. Craftsman 1/4-Inch Straight Die Grinder

- 20,000 rpm.
- 4.0 SCFM air consumption.
- 1/4-in. air inlet NPT. Wt. 1.4 lbs.

009-19952 59.99

[Get the Latest Price Online](#)

### 3-Piece Carbide Bur Set

009-16046 Wt. 0.28 lb. 29.99

[Get the Latest Price Online](#)

### H. Craftsman 1/4-Inch Right-Angle Die Grinder

- 20,000 rpm.
- 3.7 SCFM air consumption.
- 1/4-in. air inlet NPT.
- 5:4 gear reduction for higher torque. Wt. 1.1 lbs.

009-19951 69.99

[Get the Latest Price Online](#)

### 2-Inch Sanding Disc Assortment

009-16410 Wt. 0.25 lb. 14.99

[Get the Latest Price Online](#)

### J. Craftsman Cut-Off Tool with 2 7/8-Inch Wheel

- Clear shield; 20,000 rpm.
- 4.5 SCFM air consumption.
- 1/4-in. air inlet NPT. Wt. 1.75 lbs.

009-19953 69.99

[Get the Latest Price Online](#)

### Cut-Off Wheels, 6-Pack

009-18834 Wt. 0.25 lb. 10.99

[Get the Latest Price Online](#)





K  
+

## 3/8-INCH DRILL

### K. Craftsman 3/8-Inch Reversible Drill

- 2200 rpm.
- 3.3 average CFM rating.
- 1/4-in. air inlet NPT. Wt. 2.1 lbs.

009-19950 79.99  
Get the Latest Price Online



L  
+

## IMPACT HAMMER

### L. Craftsman Impact Hammer

- Low-weight composite design.
- 3.2 SCFM; 3000 bpm.
- 1/4-in. air inlet NPT. Wt. 3.25 lbs.

009-19897 39.99  
Get the Latest Price Online

4-Piece Chisel Set  
009-18687 Wt. 1.4 lbs. 25.99  
Get the Latest Price Online



## 1/2-INCH DRILL

CRAFTSMAN  
PROFESSIONAL

R  
+

## 3/8-INCH DRILL

S  
+

## 3/8-INCH RIGHT-ANGLE DRILL

T  
+

CRAFTSMAN

Catalog/Online EXCLUSIVE

### R. Craftsman Professional® 1/2-Inch One Touch Drill

- One-touch forward/reverse.
- 84 in.lbs. torque; delivers 800 rpm.
- Comfortable pistol grip; thru-handle exhaust.
- 4.0 SCFM @ 90 psi; 1/4-in. air inlet. Wt. 4 lbs.

009-19912 199.99  
Get the Latest Price Online

Catalog/Online EXCLUSIVE

### S. Craftsman Professional 3/8-Inch One Touch Reversible Drill

- 1/2-hp motor delivers up to 1800 rpm.
- 35 in.lbs. torque; thru-handle exhaust.
- 4.0 SCFM @ 90 psi; 1/4-in. air inlet; keyless chuck.

Wt. 2.6 lbs.  
009-19904 169.99  
Get the Latest Price Online

Catalog/Online EXCLUSIVE

### T. Craftsman 3/8-Inch Right Angle Reversible Drill

- 1/2-hp motor delivers up to 1800 rpm.
- 36 in.lbs. torque; thru-handle exhaust.
- 5.0 SCFM @ 90 psi; 1/4-in. air inlet; keyless chuck.

Wt. 2.66 lbs.  
009-18514 104.99  
Get the Latest Price Online



M  
+

### M. Craftsman Single Shot Lube Gun

- Heavy-duty spring-and-piston design allows self-priming.
- Loads three ways: 14-oz. cartridge, bulk-filled, or canister-filled.
- Balanced head design; 40:1 output ratio with 2400 to 6000 lbs. output pressure; 1.0 SCFM @ 90 psi. Warranted.\*

Wt. 3.4 lbs.  
009-19958 29.99  
Get the Latest Price Online



N  
+

### N. Craftsman High Volume Low Pressure Gravity-Feed Spray Gun

- Designed for high output and low overspray; features die-cast alloy gun body with stainless steel inlet and needle, 20-oz. feed cup, 1.5-mm fluid tip, and adjustable fluid and spray controls with setting markers.
- Requires 8.5 SCFM @ 40 psi; includes air regulator with gauge. Wt. 3 lbs.

009-15531 119.99  
Get the Latest Price Online



P  
+

### P. Craftsman Automotive Spray Gun

- Get glass-smooth finishes with this non-bleeder-type gun.
- Features machined brass external air cap and hardened steel fluid tip for longer life.
- 7.0 SCFM @ 40 psi. Wt. 2.93 lbs.

009-15535 89.99  
Get the Latest Price Online



Q  
+

### Q. Craftsman High Volume Low Pressure Spray Gun

- Operates with minimal overspray; tip openings and needles have been enlarged.
- Spray cap has more and larger holes to create a high-volume, low-pressure spray.
- One-quart capacity; requires 7.0 SCFM @ 40 psi. Warranted.\* Wt. 4 lbs.

009-15519 109.99  
Get the Latest Price Online

\*Warranted, see page 112.



**+** A **1/2-INCH DRIVE**



**B 1/2-INCH DRIVE DEEP**



**CRAFTSMAN® DUAL-MARK IMPACT SOCKETS**

- Features large Dual-Mark size stamp for easy identification, even in low lighting.
- Dual markings resist fading.
- Dual Advantage: Rigorous use may wear off the black oxide coating, making laser etching more difficult to read; but Dual-Mark sockets are also hard stamped.



Catalog/Online EXCLUSIVE

**C. Craftsman 8-Piece Impact Drive Tool Accessory Set**

- Includes 3/8-in. drive, two extension bars (3 and 6 in.); 1/2-in. drive, three extension bars (3, 6 and 10 in.); two universal joints (3/8 and 1/2 in.) and one 1/2 to 3/8-in. adapter.
- Separate prices total \$96.92. Wt. 3.7 lbs.

009-15358 **54.99**

**Get the Latest Price Online**

**D. Craftsman 3-Piece 1/2-Inch Drive Impact Accessory Set**

- Includes 3- and 6-in. extension bars, universal joint and 1/2-in. drive.
- For use with all impact drivers. Wt. 1.24 lbs.

009-15888 **29.99**

**Get the Latest Price Online**

**3-Piece 3/8-Inch Drive Impact Accessory Set**

- Includes 3/8-in. drive, two extension bars (3 and 6 in.) and one 3/8 to 1/2-in. adapter.
- For use with all impact drivers. Wt. 1.24 lbs.

009-15889 Wt. 0.7 lb. **29.99**

**Get the Latest Price Online**

**E. Craftsman 7-Piece 1/2-Inch Drive Dual-Mark Impact Deep Lug Nut Set**

- Includes 1/2-in. drive socket sizes 13/16, 7/8, 3/4, 15/16 in. and 17, 19 mm; plus 6-in. extension bar.
- Separate prices total \$81.93. Wt. 4.8 lbs.

009-15359 **39.99**

**Get the Latest Price Online**

Catalog/Online EXCLUSIVE

**F. Craftsman 2-Piece Dual-Mark Swivel Universal Impact Adapter Set**

- Pinless swivel design provides flexibility; Includes 3/8 and 1/2-in. adapters.
- Separate prices total \$79.98. Wt. 1.03 lbs.

009-15369 **59.99**

**Get the Latest Price Online**



**A. Craftsman® 12-Piece 1/2-Inch Drive Dual-Mark Inch Impact Socket Set**

- 12 inch sockets (3/8 thru 1 1/16 in.).
- Wt. 4.13 lbs.

009-15884 **59.99**

**Get the Latest Price Online**

**1/2-Inch Drive Metric Set**

- 12 metric sockets (12 thru 19, 21, 22, 24, 27 mm).
- Wt. 4.13 lbs.

009-15885 Wt. 4.13 lbs. **59.99**

**Get the Latest Price Online**

**9-Piece 3/8-Inch Drive Inch Set**

- 9 inch sockets (1/4 thru 3/4 in.).
- Wt. 1.53 lbs.

009-15880 Wt. 1.53 lbs. **34.99**

**Get the Latest Price Online**

**3/8-Inch Drive Metric Set**

- 9 metric sockets (10 thru 15, 17, 18, 19 mm).
- Wt. 1.53 lbs.

009-15881 Wt. 1.53 lbs. **34.99**

**Get the Latest Price Online**

**B. Craftsman 12-Piece 1/2-Inch Drive Dual-Mark Inch Deep Impact Socket Set**

- 12 inch deep sockets (3/8 thru 1 1/16 in.).
- Wt. 7.66 lbs.

009-15886 **89.99**

**Get the Latest Price Online**

**1/2-Inch Drive Metric Deep Set**

- 12 metric deep sockets (12 thru 19, 21, 22, 24, 27 mm).
- Wt. 7.66 lbs.

009-15887 Wt. 7.66 lbs. **89.99**

**Get the Latest Price Online**

**9-Piece 3/8-Inch Drive Inch Deep Set**

- 9 inch deep sockets (1/4 thru 3/4 in.).
- Wt. 2.43 lbs.

009-15882 Wt. 2.43 lbs. **49.99**

**Get the Latest Price Online**

**3/8-Inch Drive Metric Deep Set**

- 9 metric deep sockets (10 thru 15, 17, 18, 19 mm).
- Wt. 2.43 lbs.

009-15883 Wt. 2.43 lbs. **49.99**

**Get the Latest Price Online**



**EASY TO SEE, DU**  
**1/2-INCH LUG NUT**  
Get th





# ULTIMATE 3/8 AND 1/2 DRIVE, INCH & METRIC IMPACT SET



## G. 95-PIECE DUAL-MARK IMPACT SOCKET SET

- |                                       |                                       |
|---------------------------------------|---------------------------------------|
| <b>19</b> 3/8-inch drive sockets      | <b>24</b> 1/2-inch drive sockets      |
| <b>19</b> 3/8-inch drive deep sockets | <b>24</b> 1/2-inch drive deep sockets |
|                                       | <b>9</b> specialty tools              |

**DUAL-MARK SOCKETS ARE LASER ETCHED AND STAMPED TO RESIST FADING**

Catalog/Online EXCLUSIVE  
**G. Craftsman 95-Piece Dual-Mark Ultimate Impact Socket Set**  
 • Separate prices total \$809.05.  
 Wt. 30.69 lbs.  
 009-15383 **349.99**  
**Get the Latest Price Online**



air drive tools

# DUAL-MARK DESIGN SAVES TIME

Get the right impact socket every time



H



Catalog/Online EXCLUSIVE

## H. Craftsman 62-Piece 3/8-Inch Dual-Mark Impact Socket Set

- 3/8-in. drive sizes include six inch (7/16 thru 3/4 in.), three metric (13 thru 15 mm), nine inch deep (1/4 thru 3/4 in.), six metric deep (10 thru 15 mm), two extension bars (3 and 6 in.).
- 1/2-in. drive sizes include nine inch (1/2 thru 1 in.), eight metric (12 thru 19 mm), nine inch deep (1/2 thru 1 in.), eight metric deep (12 thru 19 mm), one 6-in. extension bar and one 3/8-in. adapter.
- Warranted.\* Wt. 19.5 lbs.

009-15382 **199.99**  
**Get the Latest Price Online**

Catalog/Online EXCLUSIVE

## J. Craftsman 55-Piece 1/2-Inch Drive Dual-Mark Impact Socket Set

- Includes 12 inch sockets (3/8 thru 1 1/16 in.), 12 metric sockets (12 thru 19, 21, 22, 24 and 27 mm), 12 inch deep sockets (3/8 thru 1 1/16 in.), 12 metric deep sockets (12 thru 19, 21, 22, 24 and 27 mm), universal joint, swivel universal joint, 3, 6 and 10-in. extension bars, 3/8-in. adapter and 3/4 x 13/16-in. double-end socket.
- Separate prices total \$576.85. Warranted.\* Wt. 26.7 lbs.

009-83127 **249.99**  
**Get the Latest Price Online**

**3/8-INCH DRIVE**



J

## 1/2-INCH DRIVE



\*Warranted, see page 112.



# WHY CRAFTSMAN® FOR **garage**

**LARGE SELECTION,  
BIG BRANDS,  
BEST VALUES**

**CUSTOM STORAGE,  
ULTIMATE ORGANIZATION,  
TONS OF OPTIONS**

**CRAFTSMAN®**

A **new** 



B **new** 

C **new** 



**A, B, D & E. Craftsman®  
Tool Chests**

- Designed for the most demanding professional work environments.
- Steel cage construction and GRIPATCH® drawer latching system.
- Industrial grade ball-bearing drawer slides hold up to 200 lbs. per drawer.

**A. new** Craftsman 46-Inch 10-Drawer Top Chest  
• 46W x 24D x 24 1/2H in. Wt. 340 lbs.  
009-29149N♦ 1,299.99  
**Get the Latest Price Online**

**B. new** Craftsman 46-Inch 13-Drawer Bottom Cart  
• 6 x 2-in. casters support up to 2600 lbs.  
• 46W x 24D x 42 1/2H in. Wt. 431 lbs.  
009-02915N♦ 1,699.99  
**Get the Latest Price Online**

Catalog/Online EXCLUSIVE

**C. new** Craftsman® Side Locker  
• Mounts to either side of Craftsman combo A & B or D & E.  
• Four adjustable drawers; lockable and reversible door with pegboard piercings.  
• 18 1/2W x 21D x 59 1/4H in. Wt. 164 lbs.  
009-29216N♦ 699.99  
**Get the Latest Price Online**

**D. Craftsman 36-Inch 5-Drawer Top Chest**  
• 36W x 21D x 24 1/2H in. Wt. 210 lbs.  
009-81337N♦ 999.99  
**Get the Latest Price Online**

**E. Craftsman 36-Inch 7-Drawer Bottom Cart**  
• 6 x 2-in. casters support up to 2600 lbs.  
• 36W x 21D x 42 1/2H in. Wt. 308 lbs.  
009-81338N♦ 1,249.99  
**Get the Latest Price Online**

## DID YOU KNOW?

Craftsman tool chests sold at Sears in the last five years could be lined up from Los Angeles to New York City.

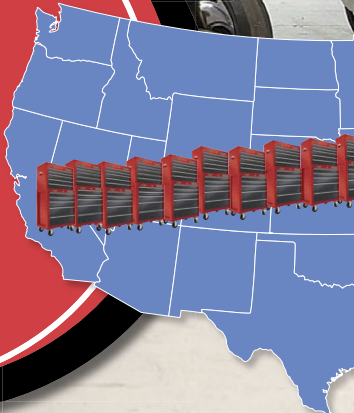



# e storage



# garage storage



**SPECIALTY  
STORAGE**  
SEE PAGES  
97-99

**SEE PAGE  
89**  
FOR THIS  
INNOVATIVE  
CRAFTSMAN®  
STADIUM  
ORGANIZATION  
COMBO



**BASIC TO  
PREMIUM  
STORAGE**  
SEE PAGES  
86-96



**GARAGE ORGANIZATION/  
STORAGE**  
SEE PAGES  
103-111

◆ See "N" suffix note on page 112.



**CRAFTSMAN**<sup>®</sup>

5

must see, m  
innoc

CONTOUR—UN

built-in power strip  
puts energy where  
you need it

pegboard & hooks  
for quick power  
tool access

43-INCH CONTOUR  
POWER STORAGE COMBO

all new

CAN YOUR  
STORAGE DO THIS?

1

28-INCH  
CONTOUR  
STORAGE  
COMBO

**A and B. Craftsman<sup>®</sup>  
10-Drawer, 43-Inch Contour  
Power Storage Combo**

- Organizes hand tools, air tools and power tools.
- Deep open front till for fast access with built-in power strip for charging cordless power tools.
- Adjustable shelf in cabinet locker; ball-bearing drawer slides.

**A. Craftsman 5-Drawer, 43-Inch Contour Power Top Chest**  
• 12,159 cu. in. of storage.  
• 15 3/4-in. drawer depth.  
• 42 1/2W x 17 3/4D x 25 1/2H in.  
Wt. 138.9 lbs.▼  
009-29685 Black 679.99  
**Get the Latest Price Online**

**B. Craftsman 5-Drawer, 43-Inch Contour Power Roller Cabinet**  
• 12,544 cu. in. of storage.  
• 15 3/4-in. drawer depth.  
• 43 1/4W x 18 1/8D x 35H in.  
Wt. 176.4 lbs.▼  
009-29686 Black 699.99  
**Get the Latest Price Online**

**C and D. Craftsman<sup>®</sup>  
8-Drawer, 28-Inch Contour  
Storage Combo**

- Compliments any workspace or storage area.
- Black wrinkle scratch-resistant powder coat paint job.
- Ball-bearing drawer slides; heavy duty casters.

**C. Craftsman 4-Drawer, 28-Inch Contour Top Chest**  
• 4,984 cu. in. of storage.  
• 15 3/4-in. drawer depth.  
• 27 3/4W x 17 3/4D x 18 3/4H in.  
Wt. 77.2 lbs.  
009-29683 Black 299.99  
**Get the Latest Price Online**

**D. Craftsman 4-Drawer, 28-Inch Contour Roller Cabinet**  
• 7,203 cu. in. of storage.  
• 15 3/4-in. drawer depth.  
• 28 1/4W x 18 1/8D x 34H in.  
Wt. 94.8 lbs.  
009-29684 Black 359.99  
**Get the Latest Price Online**



Must have storage ideas

# Innovation

UNLIKE ANY STORAGE EVER CREATED



### Bryan Willmer

"Over the years, Craftsman has always introduced innovative ideas. I like the sleek design and powder coated finish to these tool chests—all my main tools are in one spot where I can find them."

Learn more about Bryan at [sears.com/shoptools](http://sears.com/shoptools)

AVAILABLE  
MAY 15, 2011  
PRE-ORDER  
ONLINE NOW!



SNAP THIS CODE WITH YOUR MOBILE DEVICE AND SEE A VIDEO ON BRYAN WILLMER

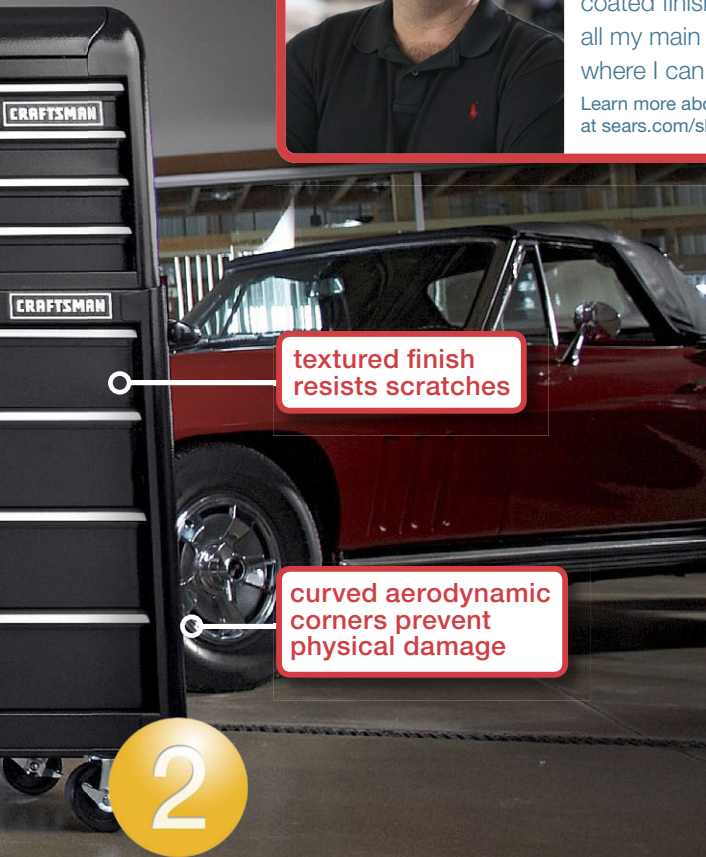

textured finish resists scratches

curved aerodynamic corners prevent physical damage



**E. Craftsman® 26-Inch Stadium Organization Top Chest**  
• 5,954 cu. in. of storage.  
• 26 3/4W x 17D x 18 1/2H in.  
Wt. 73.3 lbs.▼

009-29687 **399.99**  
**Get the Latest Price Online**

**F. Craftsman 6-Drawer, 26-Inch Roller Cabinet**  
• 9,231 cu. in. of storage.  
• 15 3/4-in. drawer depth.  
• 26 3/4W x 18 1/8D x 40 3/4H in.  
Wt. 135.1 lbs.

009-29688 **599.99**  
**Get the Latest Price Online**

**E and F. Craftsman® 6-Drawer, 26-Inch Stadium Organization Combo**

- Top chest with 16-gauge steel construction, fully welded seams and secure latching.
- Holds over 90 drive sockets in 1/2, 3/8 or 1/4-inch sizes.
- With 6 drawers, trays, cubbie storage and more.



17 hooks store more wrenches

26-INCH  
STADIUM  
ORGANIZATION  
COMBO

E

F

lift up tray perfect socket organization

F

+

F

+

F

+

F

+



## BASIC STORAGE

Value driven storage for general duty tools, perfect for first time homeowners. 1-year limited warranty.\*



# SELECT FROM DESIGNED TO

## BASIC STORAGE

- for simple storage
- drawers hold up to 25 lbs. each
- supports up to 500 lbs.

### 14-DRAWER



### 8-DRAWER

**A GREAT VALUE ON THIS BASIC STORAGE WITH BALL-BEARING DRAWER SLIDES**

#### A. Craftsman® 5-Drawer Top Chest

- Ball-bearing drawer slides.
- 3,767 cu. in. of storage.
- 10 3/4-in. drawer depth.
- 26W x 12D x 17 1/4H in. Wt. 37 lbs.

009-25911 129.99  
Get the Latest Price Online

#### B. Craftsman 2-Drawer Middle Chest

- Ball-bearing drawer slides.
- 1,918 cu. in. of storage.
- 10 3/4-in. drawer depth.
- 26W x 12D x 11 1/2H in. Wt. 33 lbs.

009-25913 89.99  
Get the Latest Price Online

#### C. Craftsman 4-Drawer Bottom Chest

- Ball-bearing drawer slides.
- 8,306 cu. in. of storage.
- 16 1/2-in. drawer depth.
- 26 1/2W x 18D x 32 1/2H in. Wt. 64 lbs.

009-25912N 189.99  
Get the Latest Price Online



# FROM FOUR STORAGE LEVELS TO ORGANIZE IT ALL FOR YOU

basic storage

## HEAVY-DUTY STORAGE

- for a more durable storage solution
- better drawer strength at 50 lbs.
- supports up to 600 lbs.

SEE PAGES 92-93



## PREMIUM HEAVY-DUTY STORAGE

- GRIPLATCH® drawer retention system
- store virtually anything with 70 lb. drawers
- supports up to 1000 lbs.

SEE PAGES 94-95



## SPECIALTY STORAGE

- custom made for special storage or organization
- industrial storage
- utility carts
- portability
- truck storage

SEE PAGES 96-99



**CRAFTSMAN**®



### D-H. 14- and 8-DRAWER BASIC STORAGE

#### D. Craftsman 7-Drawer Basic Top Chest

- 3,767 cu. in. of storage.
- 10 3/4-in. drawer depth.
- 26W x 12D x 17 1/4H in. Wt. 40 lbs.

009-12731

Platinum/Black  
**Get the Latest Price Online**

129.99

#### E. Craftsman 2-Drawer Basic Middle Chest

- 1,918 cu. in. of storage.
- 10 3/4-in. drawer depth.
- 26W x 12D x 11 1/2H in. Wt. 21 lbs.

009-12732

Platinum/Black  
**Get the Latest Price Online**

89.99

#### F. Craftsman 5-Drawer Basic Bottom Chest

- 8,343 cu. in. of storage.
- 16 1/2-in. drawer depth.
- 26 1/2W x 18D x 32 1/2H in. Wt. 67 lbs.

009-12733N

Platinum/Black  
**Get the Latest Price Online**

189.99

#### G. Craftsman 4-Drawer Basic Top Chest

- 3,350 cu. in. of storage.
- 10 3/4-in. drawer depth.
- 26W x 12D x 15 1/4H in. Wt. 33 lbs.

009-12728

Platinum/Black  
**Get the Latest Price Online**

89.99

#### H. Craftsman 4-Drawer Basic Bottom Chest

- 8,306 cu. in. of storage.
- 16 1/2-in. drawer depth.
- 26 1/2W x 18D x 32 1/2H in. Wt. 64 lbs.

009-12729N

Platinum/Black  
**Get the Latest Price Online**

109.99



# FOR THE PRO OR HO

Choose finishes, drawer combos or

## CRAFTSMAN®

### CUSTOMIZE YOUR STORAGE WITH ADD-ONS



40-INCH

#### ADDITIONAL STORAGE OPTIONS

A. 2-Shelf Side Chest Catalog/Online EXCLUSIVE	B. 6-Drawer Side Chest Catalog/Online EXCLUSIVE	C. 2-Drawer Middle Chest	D. 3-Drawer Middle Chest	E. 6-Drawer Side Caddy Catalog/Online EXCLUSIVE
17 3/4W x 10 1/2D x 29 1/4H in.	15 3/4W x 18D x 35 1/4H in.	26 1/2W x 16D x 10 1/4H in.	26 1/2W x 12D x 12 1/4H in.	7 7/8W x 12D x 15 1/8H in.
4,956 cu. in. of storage	5,649 cu. in. of storage	2,023 cu. in. of storage	1,968 cu. in. of storage	868 cu. in. of storage
Mount to either side of any Craftsman bottom chest Shelves adjust at 3-in. intervals Wt. 38 lbs.	Drawer depth 16 1/2 in. Mount to either side of a 40-in. or taller Craftsman bottom chest Wt. 85 lbs.	Drawer depth 14 5/8 in. Fit between any Craftsman 26-in. wide top and bottom chest Wt. 38 lbs.	Drawer depth 10 3/4 in. Fit between any Craftsman 12-in. deep top chest and 26 in. bottom chest Wt. 36 lbs.	Drawer depth 10 3/4 in. Mount to either side of any Craftsman bottom chest Quiet Glide® drawer slides Wt. 24 lbs.
009-81314 -Red/Black 009-61918 -Black 009-65763 -Red 009-81315 -Platinum/Black	009-81335 -Red/Black 009-82559 -Black 009-82560 -Red 009-65297 -Platinum/Black	009-12736 -Red/Black 009-62028 -Black 009-87739 -Red 009-87742 -Platinum/Black	009-62022 -Red/Black 009-61807 -Black 009-87733 -Red 009-87736 -Platinum/Black	009-65142 -Red/Black 009-61916 -Black 009-61913 -Red 009-81313 -Platinum/Black
\$99.99	299.99	149.99	149.99	99.99

Get the Latest Price Online

#### 40-INCH WIDE TOOL CHESTS

F. 8-Drawer Top Chest	G. 14-Drawer Bottom Cart
40 1/2W x 16D x 19 3/4H in.	40 3/4W x 18D x 40 3/4H in.
9,434 cu. in. of storage	16,362 cu. in. of storage
Drawer depth 14 5/8 in. Cover stay Wt. 125 lbs.	Drawer depth 16 1/2 in. Exclusive I-Frame® construction Wt. 260 lbs.
009-13287N♦ -Red/Black 009-82547N♦ -Black 009-82550N♦ -Red 009-82552N♦ -Platinum/Black	009-13288N♦ -Red/Black 009-82548N♦ -Black 009-82551N♦ -Red 009-82553N♦ -Platinum/Black
\$449.99	649.99

Get the Latest Price Online



**P. Craftsman® Bottom Chest Drawer Trays**

- Includes three trays with small, medium and large receptacles.
- Fits all 22 1/2W x 16 1/2D x 3H-in. drawers.
- Wt. 2.2 lbs.▼

009-65297 19.99

Get the Latest Price Online



**Q. Craftsman Top Chest Drawer Tray**

- Eleven receptacles hold small items.
- Fits all 22 1/2W x 10 3/4D x 2H-in. drawers. Wt. 0.5 lb.▼

009-65296 9.99

Get the Latest Price Online

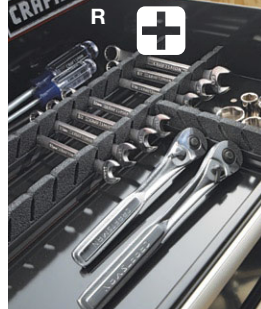

**R. Craftsman Drawer Divider System**

- Organize up to 3 top chest drawers or 2 bottom chest drawers.
- Slotted foam dividers hold up to 19 wrenches.
- Easy installation with no holes to drill. Wt. 0.7 lb.▼

009-65397 12.99

Get the Latest Price Online



# MAKE WORKSPACE

accessories for your layout

# HEAVY-DUTY STORAGE

Our best selling storage line is anchored by rugged ball-bearing drawers. 3-year limited warranty.\*



26 INCH UNITS



10-DRAWER UNITS

CHOOSE YOUR FINISH

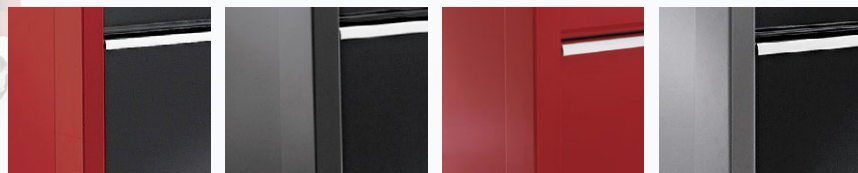

red/black

black

red

platinum/black

Share

12-DRAWER

heavy-duty storage

## 26-INCH WIDE TOOL CHESTS

H. 6-Drawer Top Chest	J. 6-Drawer Bottom Chest	K. 5-Drawer Top Chest	L. 5-Drawer Bottom Chest	M. 6-Drawer Top Chest	N. 4-Drawer Bottom Chest
26W x 16D x 19 3/4H in.	26 1/2W x 18D x 40 3/4H in.	26W x 16D x 19 3/4H in.	26 1/2W x 18D x 33 3/4H in.	26W x 12D x 15 3/8H in.	26 1/2W x 18D x 33 3/4H in.
6,116 cu. in. of storage	10,781 cu. in. of storage	6,095 cu. in. of storage	8,434 cu. in. of storage	3,458 cu. in. of storage	8,513 cu. in. of storage
Drawer depth 14 5/8 in.	Drawer depth 16 1/2 in.	Drawer depth 14 5/8 in.	Drawer depth 16 1/2 in.	Drawer depth 10 3/4 in.	Drawer depth 16 1/2 in.
Two narrow drawers for small parts Wt. 81 lbs.	Exclusive I-Frame® construction Wt. 152 lbs.	Cover stay Wt. 79 lbs.	Exclusive I-Frame® construction Wt. 118 lbs.	Locking security drawer Wt. 65 lbs.	Exclusive I-Frame® construction Wt. 103 lbs.
009-12735 -Red/Black 009-82576 -Black 009-82573 -Red 009-82578 -Platinum/Black	009-12737N◆ -Red/Black 009-82577N◆ -Black 009-82574N◆ -Red 009-82580N◆ -Platinum/Black	009-13990 -Red/Black 009-62026 -Black 009-87738 -Red 009-87741 -Platinum/Black	009-13620N◆ -Red/Black 009-62027N◆ -Black 009-87740N◆ -Red 009-87743N◆ -Platinum/Black	009-62020 -Red/Black 009-61805 -Black 009-87732 -Red 009-87735 -Platinum/Black	009-62021N◆ -Red/Black 009-61809N◆ -Black 009-87734N◆ -Red 009-87737N◆ -Platinum/Black
\$299.99	499.99	249.99	349.99	149.99	299.99

Get the Latest Price Online

## ACCESSORIES TO OUTFIT YOUR STORAGE



S

### S. Craftsman 6 x 2-Inch Caster Set

- 2 fixed; 2 swivel/locking.
- Use on any Craftsman 40-in. or wider cart.
- Increase load rating to 2500 lbs. Wt. 15 lbs.

009-65207 79.99

### 5 x 2-Inch Caster Set (without Craftsman logo)

009-65276 Wt. 10 lbs. 39.99

Get the Latest Price Online

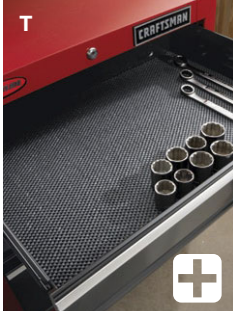

T

### T. Craftsman Open Weave Liner Roll

- Roll of material can be cut to fit any need.
- Prevents tools from sliding in drawers.
- 22 1/8W x 85 1/2L in. Wt. 1 lb.▼

009-65514 24.99

### Foam Liner Roll

009-65502 Wt. 1 lb. 13.99

Get the Latest Price Online

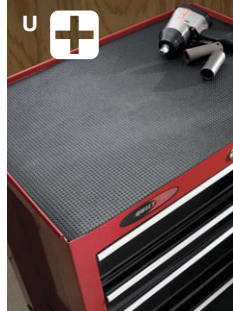

U

### U. Craftsman Top Mat

- Black protective mat for the surface of any 26-in. wide Craftsman bottom chest.
- Diamond embossed pattern.
- 26 1/4W x 17 3/4L in. Wt. 1.7 lbs.▼

009-65660 14.99

Get the Latest Price Online

\*Warranted, see page 112.  
◆ See "N" suffix note on page 112.  
▼ Accessories/props not included.



# THE BEST SHOPS USE

Ball-bearing, smooth gliding drawers



**52-INCH  
23-DRAWER**



**40-INCH  
22-DRAWER**

Accessories/props not included.

## CHOOSE YOUR FINISH

### STANDARD



black



red



red/black



platinum/black



midnight blue

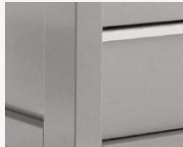

stainless steel

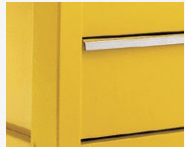

yellow

### PREMIUM

52-INCH WIDE TOOL CHESTS	
A. 9-Drawer Top Chest	B. 14-Drawer Bottom Cart
52W x 16D x 19 3/4H in. 12,218 cu. in. of storage Drawer depth 14 5/8 in. Two cover stays Stainless Steel is 18D in.	52W x 18D x 41 1/2H in. 20,952 cu. in. of storage Drawer depth 16 1/2 in. 1/2-in. thick MDF worksurface Exclusive I-Frame® construction
Painted Wt. 190 lbs. Stainless Steel Wt. 161 lbs.	Painted Wt. 345 lbs. Stainless Steel Wt. 293 lbs.
Standard Colors	
009-59629N◆ - Black 009-59729N◆ - Red/Black 009-13251N◆ - Red 009-82495N◆ - Platinum/Blk 009-59381N◆ - Midnight Blue	009-59631N◆ - Black 009-59731N◆ - Red/Black 009-13252N◆ - Red 009-82496N◆ - Platinum/Blk 009-59382N◆ - Midnight Blue
\$799.99	1,199.99
Premium Finishes	
009-82497N◆ - Yellow 009-82493N◆ - Stainless Steel	009-82498N◆ - Yellow 009-82494N◆ - Stainless Steel
\$899.99	1,299.99
<a href="#">Get the Latest Price Online</a>	

40-INCH WIDE TOOL CHESTS	
C. 8-Drawer Top Chest	D. 14-Drawer Bottom Cart
40 1/2W x 16D x 19 3/4H in. 9,434 cu. in. of storage Drawer depth 14 5/8 in. Security drawer locks independently Stainless Steel is 18D in.	40 3/4W x 18D x 41 1/2H in. 16,362 cu. in. of storage Drawer depth 16 1/2 in. 1/2-in. thick MDF worksurface Exclusive I-Frame® construction
Painted Wt. 141 lbs. Stainless Steel Wt. 115 lbs.	Painted Wt. 260 lbs. Stainless Steel Wt. 230 lbs.
Standard Colors	
009-59623N◆ - Black 009-59723N◆ - Red/Black 009-13626N◆ - Red 009-82505N◆ - Platinum/Blk 009-59168N◆ - Midnight Blue	009-59624N◆ - Black 009-59724N◆ - Red/Black 009-13628N◆ - Red 009-82506N◆ - Platinum/Blk 009-59169N◆ - Midnight Blue
\$499.99	899.99
Premium Finishes	
009-82507N◆ - Yellow 009-13246N◆ - Stainless Steel	009-82508N◆ - Yellow 009-13244N◆ - Stainless Steel
\$599.99	999.99
<a href="#">Get the Latest Price Online</a>	

### E. Craftsman® Non-Slip Drawer Liner Roll

- Keeps tools in place and protects tools and drawers.
- 22 1/8W x 85 1/2L in. Wt. 1 lb.▼

009-65514 24.99



**E**



# THE BEST STORAGE

Drawers, premium gauge steel

13-DRAWER

**CRAFTSMAN®**



16-DRAWER



## PREMIUM HEAVY-DUTY STORAGE

Griplatch® drawers stay put until you need to open them, then open with ease. 5-year limited warranty.\*



### CUSTOMIZE YOUR STORAGE WITH ADD-ONS



FULL-HEIGHT SIDE LOCKER



SIDE CHEST



MIDDLE CHEST

Share

40-INCH UNITS

premium storage

#### 40-INCH WIDE TOOL CHESTS

F. 7-Drawer Top Chest Catalog/Online EXCLUSIVE	G. 6-Drawer Bottom Cart Catalog/Online EXCLUSIVE	H. 5-Drawer Top Chest	J. 11-Drawer Bottom Cart
40 1/2W x 16D x 20 3/4H in. 9,597 cu. in. of storage Drawer depth 14 5/8 in. Full-width bottom drawer Two cover stays Security drawer locks independently Painted Wt. 134 lbs. Stainless Steel Wt. 109 lbs.	40 3/4W x 18D x 41 1/2H in. 17,668 cu. in. of storage Drawer depth 16 1/2 in. 1/2-in. thick MDF worksurface Exclusive I-Frame® construction Painted Wt. 240 lbs. Stainless Steel Wt. 212 lbs.	40 1/2W x 18D x 20H in. 11,017 cu. in. of storage Drawer depth 16 1/2 in. Full-width bottom drawer Two cover stays Security drawer locks independently Painted Wt. 153 lbs. Stainless Steel Wt. 129 lbs.	40 3/4W x 18D x 39 1/4H in. 15,862 cu. in. of storage Drawer depth 16 1/2 in. 1/2-in. thick MDF worksurface Exclusive I-Frame® construction Painted Wt. 240 lbs. Stainless Steel Wt. 212 lbs.
Standard Colors			
009-59621N◆ - Black 009-59721N◆ - Red/Black 009-81286N◆ - Red 009-82499N◆ - Platinum/Black 009-59383N◆ - Midnight Blue \$599.99	009-59626N◆ - Black 009-59726N◆ - Red/Black 009-81287N◆ - Red 009-82510N◆ - Platinum/Black 009-59387N◆ - Midnight Blue 699.99	009-13630N◆ - Black 009-13636N◆ - Red/Black 009-13635N◆ - Red 009-13495N◆ - Platinum/Black 009-13632N◆ - Midnight Blue 499.99	009-13629N◆ - Black 009-13637N◆ - Red/Black 009-13633N◆ - Red 009-13493N◆ - Platinum/Bk. 009-13631N◆ - Midnight Blue 699.99
Premium Finishes			
009-82501N◆ - Yellow — \$699.99	009-82513N◆ - Yellow — 799.99	009-13499N◆ - Yellow 009-10595N◆ - Stainless Steel 599.99	009-13497N◆ - Yellow 009-10600N◆ - Stainless Steel 799.99

Get the Latest Price Online

#### ADDITIONAL STORAGE OPTIONS

K. Full-Height 4-Drawer Side Locker Catalog/Online EXCLUSIVE	L. 6-Drawer Side Chest	M. 1-Drawer Middle Chest
16W x 18D x 54 3/4H in. 10,872 cu. in. of storage Drawer depth 16 1/2 in. Mount to either side of a Craftsman top and bottom chest combination Interchangeable drawers Wt. 102 lbs.	15 3/4W x 18D x 35 1/4H in. 5,649 cu. in. of storage Drawer depth 16 1/2 in. Mount to either side of a 40-in. or taller Craftsman bottom chest Painted Wt. 96 lbs. Stainless Steel Wt. 90 lbs.	40 1/2W x 18D x 7 1/2H in. 2,510 cu. in. of storage Drawer depth 16 1/2 in. Fit between any Craftsman 40-in. wide top chest and bottom carts Painted Wt. 52 lbs. Stainless Steel Wt. 48 lbs.
Standard Colors		
009-59605 - Black 009-59705 - Red 009-82503 - Platinum/Black 009-59385 - Midnight Blue Red matches Red/Black and Red storage \$519.99	009-59602 - Black 009-59702 - Red/Black 009-14120 - Red 009-82515 - Platinum/Black 009-59393 - Midnight Blue 349.99	009-59604 - Black 009-59704 - Red/Black 009-13627 - Red 009-82511 - Platinum/Black 009-59388 - Midnight Blue 249.99
Premium Finishes		
009-82504 - Yellow — \$619.99	009-82516 - Yellow 009-14121 - Stainless Steel 399.99	009-82514 - Yellow 009-13242 - Stainless Steel 299.99

Get the Latest Price Online

shopyourway rewards join now. earn today. it's free.



# PREMIUM HEAVY-DUTY STORAGE

Griplatch® drawers stay put until you need to open them with ease. 5-year limited warranty.\*



# CRAFTSMAN®

## 14-DRAWER

### 11-DRAWER



D

F



### 26-INCH UNITS



## CUSTOMIZE YOUR STORAGE WITH ADD-ONS

A 3-drawer middle chest



B 4-drawer middle chest



## CHOOSE YOUR FINISH

### STANDARD



black



red/black



red



platinum/black



midnight blue

### PREMIUM



stainless steel



yellow

ADD MORE STORAGE	
A. 3-Drawer Middle Chest	B. 4-Drawer Middle Chest Catalog/Online EXCLUSIVE
26 1/2W x 18D x 13 1/4H in.	26 1/2W x 16D x 13 1/4H in.
3,394 cu. in. of storage	2,755 cu. in. of storage
Drawer depth 16 1/2 in. Fit between any Craftsman 26-in. wide top and bottom chest	Drawer depth 14 5/8 in. Fit between any Craftsman 16-in. deep top chest and any bottom chest
Painted Wt. 61 lbs. Stainless Steel Wt. 59 lbs.	Wt. 61 lbs.
Standard Colors	
009-59603 -Black 009-59703 -Red/Black 009-13278 -Red 009-82533 -Platinum/Black 009-59392 -Midnight Blue	009-59601 -Black 009-59701 -Red/Black 009-81299 -Red 009-82519 -Platinum/Black 009-59895 -Midnight Blue
\$199.99	219.99
Premium Finishes	
009-82538 -Yellow 009-13253 -Stainless Steel	009-82522 -Yellow
\$249.99	269.99

Get the Latest Price Online

26-INCH WIDE TOOL CHESTS			
C. 5-Drawer Top Chest Catalog/Online EXCLUSIVE	D. 6-Drawer Bottom Chest Catalog/Online EXCLUSIVE	E. 6-Drawer Top Chest	F. 8-Drawer Bottom Chest
26W x 16D x 19 3/4H in.	26 1/2W x 18D x 35H in.	26W x 18D x 19 3/4H in.	26 1/2W x 18D x 41 1/4H in.
6,116 cu. in. of storage	8,375 cu. in. of storage	6,826 cu. in. of storage	10,663 cu. in. of storage
Drawer depth 14 5/8 in. Cover stay Stainless steel is 18D in.	Drawer depth 16 1/2 in. 1/2-in. thick MDF worksurface Exclusive I-Frame® construction	Drawer depth 16 1/2 in. Cover stay Extra deep chest for more storage	Drawer depth 16 1/2 in. 1/2-in. thick MDF worksurface Exclusive I-Frame® construction
Painted Wt. 105 lbs. Stainless Steel Wt. 89 lbs.	Painted Wt. 130 lbs. Stainless Steel Wt. 123 lbs.	Painted Wt. 102 lbs. Stainless Steel Wt. 86 lbs.	Painted Wt. 160 lbs. Stainless Steel Wt. 136 lbs.
Standard Colors			
009-59614 -Black 009-59714 -Red/Black 009-81297 -Red 009-82525 -Platinum/Black 009-59891 -Midnight Blue	009-59615N+ -Black 009-59715N+ -Red/Black 009-81298N+ -Red 009-82526N+ -Platinum/Black 009-59892N+ -Midnight Blue	009-59618 -Black 009-59718 -Red/Black 009-13262 -Red 009-82531 -Platinum/Black 009-59389 -Midnight Blue	009-59619N+ -Black 009-59719N+ -Red/Black 009-13280N+ -Red 009-82532N+ -Platinum/Black 009-59894N+ -Midnight Blue
\$349.99	499.99	429.99	569.99
Premium Finishes			
009-82527 -Yellow 009-82489 -Stainless Steel	009-82528N+ -Yellow 009-82490N+ -Stainless Steel	009-82536 -Yellow 009-82491 -Stainless Steel	009-82537N+ -Yellow 009-82492N+ -Stainless Steel
\$389.99	559.99	469.99	629.99

Get the Latest Price Online

\*Warranted, see page 112.

◆ See "N" suffix note on page 112.

▼ Accessories/props not included.





# SMART & DURABLE ON-THE-GO

specialty storage

## G. Craftsman® 4-Drawer Black Ball-Bearing GRIPLATCH® Utility Cart

- Provides 18,820 cu. in. of storage.
- Two full-width and two split drawers; 3-in. deep bottom shelf.
- 38 3/4W (with handle) x 21 1/4D x 41H in. Wt. 173 lbs.▼

009-59756N◆

499.99

Get the Latest Price Online

## MAGNETIC HOLDER FOR EASY TOOL ACCESS

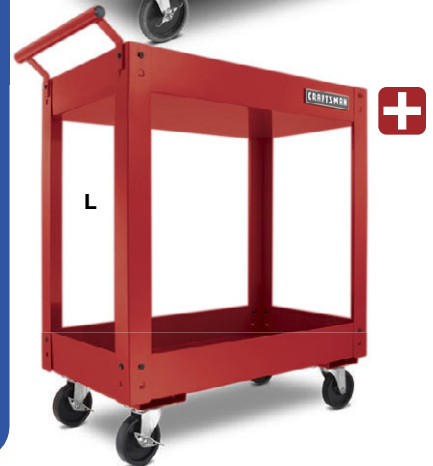

## TOP GRADE UTILITY CARTS (G & H)

- Ball-bearing drawer slides open smoothly.
- GRIPLATCH® latching system holds drawers closed.
- Rubber bumpers protect surfaces.

**BALL BEARING GRIPLATCH™**

## H. Craftsman 3-Drawer Black Ball-Bearing GRIPLATCH® Utility Cart

- One full-width and two split drawers; 3-in. deep bottom shelf.
- 34W (with handle) x 20 1/2D x 36 3/4H in. Wt. 109 lbs.

009-59740

349.99

Get the Latest Price Online

## J. Craftsman 2-Drawer Ball-Bearing Deluxe Mechanic's Cart

- Ball-bearing drawer slides with "Secure Latch" drawer retention.
- Includes folding side shelf for additional work space.

• 43 1/2W (with side shelf) x 16 1/2D x 35 1/2H in. Wt. 96 lbs.▼

009-59355

249.99

Get the Latest Price Online

## K. Craftsman Small Plastic Utility Cart

- Lightweight for maneuverability.
- 34 1/2W x 17 1/2D x 33 3/4H in. Wt. 38 lbs.

009-59732

99.99

Get the Latest Price Online

## Large Plastic Utility Cart

- 40 1/2W x 25 3/4D x 33 3/4H in. Wt. 48 lbs.

009-59733

169.99

Get the Latest Price Online

## L. Craftsman 2-Tray Service Cart

- Two 3 1/2-in. deep storage trays; hold 200 lbs. per shelf.
- Tubular steel push handle.
- 31W (with handle) x 16D x 33H in. Wt. 32 lbs.

009-59238

79.99

Get the Latest Price Online

Share



# INDESTRUCTO® CASES

- Powder-coated aluminum frames.
- TSA-approved locks included with A-E.
- Built to withstand -40°F to +185°F.

# ROAD READY

with rugged, easy travel tool kits



REMOVABLE



HINGED

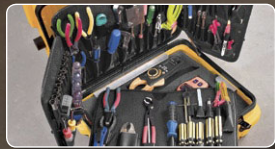

REMOVABLE  
WING

Accessories/props not included.



## CRAFTSMAN® PORTABLE/TRAVEL CASES Catalog/Online EXCLUSIVE

Catalog	Description	Pallet Style	Cart Version	Weight	Dimensions	Price
A. 009-59759	Black with red trim case holds 51 mechanical tools; includes TSA authorized combination lock	Hinged Set	Yes	19.2	18 x 15 x 12	\$284.99
B. 009-59829	Black with red trim slimline case holds 48 mechanical tools; includes TSA authorized combination lock	Hinged Set	Yes	18.75	21.5 x 12.25 x 11	259.99
C. 009-59920	Black with red trim jumbo case has 100 sewn pockets plus a complete pallet with sewn elastic so that you can customize unusual shaped tools; includes TSA authorized combination lock	Hinged Set	Yes	36	28 x 22 x 12	384.99
D. 009-59805	Black with red trim square case holds 50 mechanical tools; includes TSA authorized combination lock	Hinged Set	Yes	21.6	19 x 19 x 11	334.99
E. 009-82870	Black with red trim holds more than 50 general tools plus a pocket to hold 500 gram ball peen hammer and 13-in. half round file; includes TSA authorized combination lock	Hinged Set	Yes	25	21 x 16.5 x 12	309.99
F. 009-82871	Yellow electronic carrying case holds 50 tools	2 Removable	No	12	18 x 15 x 10	174.99
009-82872	Black color, same features	2 Removable	No	12	18 x 15 x 10	174.99
G. 009-82873	Yellow slimline electronic carrying case holds 50 tools	2 Removable	No	12	21.5 x 12.5 x 10	174.99
009-82874	Black color, same features	2 Removable	No	12	21.5 x 12.5 x 10	174.99
H. 009-59154	Black and electronic tool case holds 70 tools	Winged Set	Yes	19.2	18 x 15 x 12	284.99
009-59155	Yellow color, same features	Winged Set	Yes	19.2	18 x 15 x 12	284.99
J. 009-95244	Black and super-sized contractor case holds 78 tools	Hinged Set	Yes	29.7	23 x 18 x 12	309.99
009-95245	Yellow color, same features	Hinged Set	Yes	29.7	23 x 18 x 12	309.99
K. 009-95248	Black 31-in. extra large case holds up to 100 mechanical tools and features 3 additional clear storage pallets	Hinged Set	Yes	28.5	31 x 15 x 12	344.99
009-95180	Yellow color, same features	Hinged Set	Yes	28.5	31 x 15 x 12	344.99
L. 009-95181	Black master mechanic case holds 74 tools	Hinged Set	Yes	22	25 x 15 x 12	299.99
009-95182	Yellow color, same features	Hinged Set	Yes	22	25 x 15 x 12	299.99
M. 009-81021	Black extra large electronic case holds 52 large and medium size electronic tools	Winged Set	Yes	20	21.5 x 16.5 x 12	279.99

Get the Latest Price Online



# TOOL STORAGE

**F RED**



**TOUGH ENAMEL-FINISH STEEL**

**CRAFTSMAN®**

**FULL-EXTENSION LOCKING DRAWERS**

## CRAFTSMAN® PORTABLE CHESTS

Protect and organize your tools wherever you need them.

**G BLACK**



### F. Craftsman 4-Drawer Chest

- 1,840 cu. in. of storage.
- 20 1/2W x 8 1/2D x 14 1/4H in. Wt. 26 lbs.
- 009-61906 Red
- 009-82596 Yellow
- 009-65427 Red/Black
- 009-61904 Midnight Blue
- 009-82594 Platinum/Black
- 009-61905 Black 69.99

**Get the Latest Price Online**

### G. Craftsman 3-Drawer Chest

- 1,588 cu. in. of storage.
- 20 1/2W x 8 1/2D x 12H in. Wt. 19 lbs.
- 009-61902 Red
- 009-82595 Yellow
- 009-65337 Red/Black
- 009-65396 Midnight Blue
- 009-82593 Platinum/Black
- 009-61901 Black 59.99

**Get the Latest Price Online**

### 4 OTHER FINISHES AVAILABLE



yellow

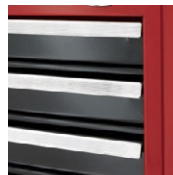

red/black



midnight blue



platinum/black

### GOOD FOR SMALL TOOLS



### H. Craftsman 18-Inch Cantilever Organizer

- Durable construction with metal handle and latches.
- Optimal visibility with tiered storage, removable bins, and clear lid.
- 18L x 9 1/2W x 5 3/4H in. Wt. 5 lbs.
- 009-21111

**Get the Latest Price Online**

24.99

### MORE DURABLE TOOL STORAGE



### J. Craftsman 3-Drawer Portable Chest

- 1,788 cu. in. of storage.
- Plastic shell guards against scratching.
- Three steel drawers with compound action slides.
- 23W x 10 1/2D x 13 1/2H in. Wt. 15.6 lbs.
- 009-65628

**Get the Latest Price Online**

49.99

### WHEELED TRANSPORT



**K**

### K. Craftsman SST2 Sit/Stand/Tote

- 5,081 cu. in. of storage.
- 5-in. wheels transport over rough surfaces.
- High-impact polypropylene.
- 36-in. telescoping handle.
- 25W x 17 1/2D x 18H in. Wt. 19 lbs.
- 009-59627

**Get the Latest Price Online**

59.99

latest price online

Get the Latest Price. [sears.com/shoptools](http://sears.com/shoptools)

specialty storage



# DESIGN YOUR WORKBENCH IN 4

## 1 CHOOSE A FRAME 6- or 8-ft., red or black

## 2 CHOOSE A WORKSURFACE 4 to choose from



**A** 6-foot, red

**A. Craftsman® Workbench Frame**  
• Leveling feet; 2-in. metal backsplash.  
• Requires “B” through “E” worksurface.  
**6-Foot Frame**

70W x 18 1/8D x 40H in. Wt. 53 lbs.  
009-14929◆ Red 169.99  
009-14928◆ Black 169.99

[Get the Latest Price Online](#)

**8-Foot Frame**  
94W x 18 1/8D x 40H in. Wt. 69 lbs.  
009-14925◆ Red 219.99  
009-14940◆ Black 219.99

[Get the Latest Price Online](#)



**B. Medium Density Fiberboard (MDF) Worksurface**  
009-01496 6-Foot. Wt. 35 lbs. 79.99  
009-14963 8-Foot. Wt. 40 lbs. 99.99

[Get the Latest Price Online](#)

**C. Butcher Block Worksurface**  
009-14961 6-Foot. Wt. 35 lbs. 129.99  
009-14965 8-Foot. Wt. 40 lbs. 159.99

[Get the Latest Price Online](#)

**D. Bamboo Worksurface**  
009-14960 6-Foot. Wt. 30 lbs. 199.99  
009-14964 8-Foot. Wt. 35 lbs. 229.99

[Get the Latest Price Online](#)

**E. Stainless Steel Worksurface**  
009-14962 6-Foot. Wt. 35 lbs. 219.99  
009-14966 8-Foot. Wt. 40 lbs. 249.99

[Get the Latest Price Online](#)

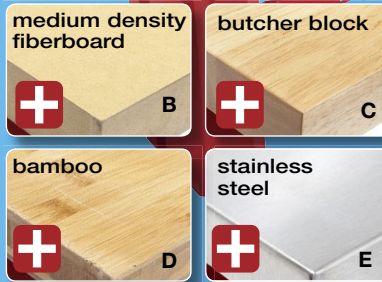

# OR GET PRE-BUILT & EFFICIENT V

### L. Craftsman 8-Foot Workbench—Red/Black

• 96W x 24D x 66 1/4H in.  
Wt. 197 lbs.

009-14925◆ 8-Foot Frame  
009-14966 Stainless Steel  
Worksurface  
Shelf Module  
009-14941 8-Foot Backwall  
009-14944 8-Foot Backwall  
809.96

[Get the Latest Price Online](#)

### M. Craftsman 6-Foot Workbench—Black/Platinum

• 72W x 24D x 66 1/4H in.  
Wt. 196 lbs.

009-14928◆ 6-Foot Frame  
009-14962 Stainless Steel  
Worksurface  
3-Drawer Module  
009-14927 6-Foot Backwall  
709.96

[Get the Latest Price Online](#)

### N. Craftsman 8-Foot Workbench—Black/Platinum

• 96W x 24D x 41 1/4H in.  
Wt. 172 lbs.

009-14940◆ 8-Foot Frame  
009-14965 Butcher Block  
Worksurface  
3-Drawer Module  
559.96

[Get the Latest Price Online](#)



**L** 8-FOOT

◆ See “N” suffix note on page 112.





# EASY STEPS

## 3 ADD STORAGE MODULES

3 to choose from, on either side or both



**F** 3-shelf module

**F. 3-Shelf Workbench Module**  
 - Wt. 32 lbs.  
 009-14941 Red 139.99  
 009-14942 Black 139.99  
**Get the Latest Price Online**



**G** 3-drawer module

**G. 3-Drawer Workbench Module**  
 - Ball-bearing drawer slides. Wt. 63 lbs.  
 009-14926 Red/Black 179.99  
 009-14927 Black/Platinum 179.99  
**Get the Latest Price Online**



**H** 5-drawer module

**H. 5-Drawer Workbench Module**  
 - Ball-bearing drawer slides. Wt. 63 lbs.  
 009-10133 Red/Black 199.99  
 009-10139 Black/Platinum 199.99  
**Get the Latest Price Online**

## 4 ADD ACCESSORIES

backwall and door kit



**J** back wall

**K** door kit

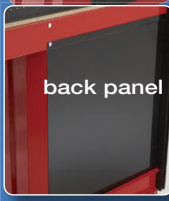

**J. Workbench Backwall**  
 - Mount to "A" workbench frame.  
 - Pegboard piercings, fluorescent worklight and 6-outlet power strip.  
 009-14943 6-Foot. Wt. 45 lbs. 139.99  
 009-14944 8-Foot. Wt. 56 lbs. 199.99  
**Get the Latest Price Online**

**K. Module Door Kit**  
 - Fits "F", "G", or "H" storage modules.  
 - Keyed lock for security.  
 - Front/back panels for dust protection.  
 009-14953 Black. Wt. 22 lbs. 49.99  
**Get the Latest Price Online**

SNAP THIS CODE WITH YOUR MOBILE DEVICE AND SEE A VIDEO ON DESIGNING YOUR OWN WORKBENCH

**SEE VIDEO**  
 at sears.com/shoptools

workbenches

# WORKBENCHES



**M** 6-FOOT



**N** 8-FOOT

latest price online

Get the Latest Price. sears.com/shoptools





**CRAFTSMAN**  
PROFESSIONAL



**SUMP**

**UTILITY**

**A. Craftsman Professional® 1/2-hp Stainless Steel Submersible Sump Pump**

- 1 1/4-in. discharge tapping.
- Pumps up to 66 gallons per minute.
- Built-in thermal overload protector; tethered float switch.
- For 12-in. diameter or larger sump basin. Wt. 16 lbs.

083-03050 159.99  
[Get the Latest Price Online](#)

**B. Craftsman Professional® 1/4-hp Submersible Utility Pump**

- Typical applications include flooded window wells and basements.
- Pumps up to 30 gallons per minute.
- High impact thermoplastic. Wt. 9 lbs.

083-02655 94.99  
[Get the Latest Price Online](#)

**SUMP WITH BATTERY BACK-UP**

**DRILL PUMP**

**C. Craftsman® Battery Back-Up Sump Pump**

- Battery back up with 5-stage/2-amp charger assures protection during outages, snow melts and primary sump pump failure.
- Pumps up to 18 GPH. Wt. 13 lbs.

083-30706 209.99  
[Get the Latest Price Online](#)

**D. Craftsman Power-Drill Pump**

- Powered by a drill; can pump small aquariums, clogged sinks, or broken washing machines.
- Self-priming; pumps up to 225 GPH. Wt. 0.3 lb.

083-02660 9.99  
[Get the Latest Price Online](#)

**WELL**

**JET**

**E. Craftsman Professional® 1/2-hp Hydro-Glass® Shallow Well Jet Pump**

- Pumps up to 8.2 GPM, based on depth of water to 20 feet or less and a 40/60 pressure rating. Wt. 25 lbs.

083-02514 209.99  
[Get the Latest Price Online](#)

**F. Craftsman Professional® 1-hp Hydro-Glass® Convertible Jet Pump**

- Pumps up to 17 GPM with shallow well Jet Package (29650), or up to 8.2 GPM with deep well Jet Package (29660).
- Draincock simplifies draining, winterization. Wt. 30 lbs.

083-02522 274.99  
[Get the Latest Price Online](#)

# FILL IT. MOVE IT. KEEP IT. LOCK IT.

**YOUR CHOICE \$579.99**

Catalog/Online EXCLUSIVE  
**G. Craftsman® 26-Inch Portable Tool Boxes in Diamond Aluminum**

- Innovative portable storage solution displays all your tools at a glance.
- 0.08-inch diamond-pattern aluminum with all-welded seams.
- Weather stripping keeps tools dry.
- Provides 5,667 cu. in. of storage.
- Measures 26W x 17 3/8D x 18 1/2H in. Wt. 47 lbs.▼

009-87706 Brite  
009-87707 Black  
009-87708 Red 579.99

[Get the Latest Price Online](#)



**CRAFTSMAN**

aluminum tread plate

**J**  
black tread

**K**  
black powder coat

**K**  
white powder coat

**CRAFTSMAN SILVER TREAD, BLACK TREAD AND POWDER-COAT STEEL SERIES TRUCK STORAGE BOXES**

- Utilizes the wasted space in the back of a truck or van wheel well.
- Units fit most pickups with bed liners, tonneau covers and caps.
- Mounting plate is easy to install.

**CRAFTSMAN TRUCK STORAGE CATALOG/ONLINE EXCLUSIVE**

Description	Fits Beds	Dimensions W x D x H (in.)	Catalog No.	Wt., lbs.	Price
<b>H. Signature Series Aluminum Tread Plate.</b>					
5-dr., full-size	8-ft.	7 3/4 x 21 3/4 x 18 7/8	009-81302	47	\$389.99
5-dr., full-size	6-ft.	7 3/4 x 18 3/4 x 18 7/8	009-81303	43	\$379.99
<b>J. Signature Series Black Aluminum Tread Exterior.</b>					
5-dr., full-size, Black	8-ft.	7 3/4 x 21 3/4 x 18 7/8	009-81300	47	\$399.99
5-dr., full-size, Black	6-ft.	7 3/4 x 18 3/4 x 18 7/8	009-81301	43	\$389.99
<b>K. All-Steel Powder-Coat Series</b>					
5-dr., full-size, Black	8-ft.	7 3/4 x 21 3/4 x 18 7/8	009-81304	47	\$239.99
5-dr., full-size, Black	6-ft.	7 3/4 x 18 3/4 x 18 7/8	009-81305	47	\$219.99
5-dr., full-size, White	8-ft.	7 3/4 x 21 3/4 x 18 7/8	009-81306	47	\$239.99
5-dr., full-size, White	6-ft.	7 3/4 x 18 3/4 x 18 7/8	009-81307	43	\$219.99

[Get the Latest Price Online](#)



**CRAFTSMAN**

PROFESSIONAL

garage storage

**PROFESSIONAL GRADE GARAGE STORAGE**

- Interior door storage conveniently organizes cleaners, cans and other general supplies.
- Zero clearance doors allow units to be positioned side by side, saving valuable space.
- Locking system secures valuable tools, supplies and chemicals.
- Fully assembled cabinets provide quick and easy setup.



Accessories/props not included.

# PRO-GRADE ADVANTAGE

## more options, more features, more security

### L. Craftsman Professional® Wall Cabinet

- Two adjustable shelves; five welded shelves inside doors; keyed lock.
- Mounts to "N" backwall, VersaTrack™ Trackwall (see pgs. 184–185), or direct to wall; fully assembled.
- 8,259 cu. in. of storage. 28W x 12 1/2D x 31H in. Wt. 80 lbs.

009-59175 179.99

**Get the Latest Price Online**

### M. Craftsman Professional 5-Foot Backwall

- Mounts to "Q" workbench, metal pegboard storage, holds "M" wall cabinet. Wt. 65 lbs.

009-59182 139.99

**Get the Latest Price Online**

### 8-Foot Backwall

009-59187 Wt. 102 lbs. 189.99

**Get the Latest Price Online**

### N. Craftsman Professional Tall Floor Cabinet

- Three shelves (two adjustable) and ten welded shelves inside doors.
- Leveling feet; keyed lock; fully assembled.

• 48,400 cu. in. of storage. 36W x 21 1/2D x 78H in. Wt. 186 lbs. 009-15341N♦ 399.99

**Get the Latest Price Online**

### Floor Locker

009-59125N♦ Wt. 171 lbs. 329.99

**Get the Latest Price Online**

### Floor Cabinet

009-59126N♦ Wt. 175 lbs. 329.99

**Get the Latest Price Online**

### P. Craftsman Professional 5-Foot Workbench

- Legs with pegboard sides and built-in shelves, leveling feet, and 1/2" steel support beam under top.
- 1-in. thick fiberboard worksurface.
- Pierced backplash holds tools.
- 60W x 24D x 39 3/4H in. Wt. 135 lbs.

009-59181N♦ 269.99

**Get the Latest Price Online**

### 8-Foot Workbench

96W x 24D x 39 3/4H in. 009-59186N♦ Wt. 180 lbs. 349.99

**Get the Latest Price Online**

### Q. Craftsman Professional 5-Drawer Mobile Cabinet

- Ball-bearing drawer slides and I-Frame® construction; caster assembly required.
- 28W x 21 1/2D x 36H in. Wt. 148 lbs.

009-59130N♦ 399.99

**Get the Latest Price Online**

- ♦ See "N" suffix note on page 112.
- ▼ Accessories/props not included.



get what you want with more ways to pay choose the plan that's right for you.

extra savings plan



save on interest plan



layaway plan

NEW monthly payment plan

see page 57 for details

latest price online

Get the Latest Price. [sears.com/shoptools](http://sears.com/shoptools)



# CHOOSE THE GARAGE DOOR O

## 1 CHOOSE A DRIVE TYPE

### BELT DRIVE

- Ultra quiet
- Steel reinforced

### CHAIN DRIVE

- Heavy-duty
- Good for most garage doors

### SCREW DRIVE

- Powerful, solid steel
- Low maintenance

## 2 CHOOSE A HORSEPOWER

### 3/4 HP

- Fastest and most powerful
- For big, heavy garage doors

### 1/2 HP

- Standard power
- For most garage doors

## SEARS NEXT DAY PROFESSIONAL INSTALLATION

Save time.  
Get it done right the first time.

We remove the old opener, install the new one, test it and show you how to use it. 1-year limited warranty.\*

Call:  
1-800-FOR-MY-HOME  
or

Go to:  
[services.sears.com/installation](http://services.sears.com/installation)  
Follow our simple 3-step process.

## IT'S NEVER BEEN EASIER!

See page 112 for Home Services Licensing Information.

\*\*Order must be made by 3 p.m. to qualify for next day installation. Installation is available on eligible garage door opener purchases made at Sears. Next day installation excludes holidays and weekends.

### CRAFTSMAN®

#### A. Craftsman® 1/2-hp Chain Drive Garage Door Opener

- Rugged drive systems.
- Two 3-function remote controls.
- Wireless, keyless entry pad; deluxe control panel.
- Safety sensors; supports up to 200W. Wt. 39.7 lbs.

009-53985 189.99  
Get the Latest Price Online



A **+** 1/2-HP CHAIN DRIVE



### CRAFTSMAN®

#### B. Craftsman 3/4-hp Chain Drive Garage Door Opener

- 50% more power and 25% faster than our 1/2-hp chain drive garage openers.
- Two 3-function remote controls and wireless, keyless entry pad.
- Deluxe control panel with motion-activated lighting; safety sensors.

Wt. 42.2 lbs.  
009-53990 229.99  
Get the Latest Price Online



B **+** 3/4-HP CHAIN DRIVE



# OPENER THAT'S RIGHT FOR YOU

**3** CHOOSE WITH OR WITHOUT BATTERY-BACKUP

**NEED MORE HELP CHOOSING THE RIGHT GARAGE DOOR OPENER?**



SNAP THIS CODE WITH YOUR MOBILE DEVICE AND GO DIRECTLY TO THE CRAFTSMAN GARAGE DOOR OPENER FINDER

Go to [www.garagedooropenerfinder.com](http://www.garagedooropenerfinder.com)

**CRAFTSMAN®**



Share

innovation

get in your garage even when the power is out



## GARAGE DOOR OPENER, DIEHARD® BATTERY BACK UP

- The DieHard® DC Battery Back up is always charged.
- Allows door-control, safety sensors and remote controls to operate on stored battery power for 20 open/close cycles.
- Never worry about a power outage again!



## PREMIUM BELT DRIVE

4

### C. Craftsman Premium Belt Drive DC-Powered Garage Door Opener with DieHard® Battery Backup

- Motion-activated lighting, wireless/keyless entry pad, safety sensors and anti-burglary coding.
- Power unit, battery, two remotes, rail, hardware and belt. Wt. 38.6 lbs.

009-53918

279.99

Get the Latest Price Online

latest price online

\*Warranted, see page 112.

Get the Latest Price. [sears.com/shoptools](http://sears.com/shoptools)

garage storage



# INTRODUCING

## CRAFTSMAN® FLEXIBLE TILE FLOORING

- **Same Craftsman quality:** now in our new professional-grade tile flooring products.
- **Multiple Uses:** garage, deck, patio, laundry room, workshop, exercise room.
- **Easy Installation:** installs in minutes with a utility knife and rubber mallet.
- **Personal Delivery:** to your home or the closest Sears store—your choice.

### A. new Craftsman® Flexible Raised Coin Flooring

- Durable, each tile designed for quiet and anti-fatigue surface walking.
  - No anchoring or adhesives required; each tile is 18 x 18 x 1/4 in.
  - 6 tiles per pack. Wt. 17 lbs.
- |                 |       |
|-----------------|-------|
| 009-25866 Beige | 39.99 |
| 009-25869 Black | 39.99 |
| 009-02587 Grey  | 39.99 |
| 009-25873 Red   | 39.99 |

**Get the Latest Price Online**

### B. new Craftsman Flexible Vented Flooring

- "Vented" so water runs through the tiles and does not accumulate on surface.
  - Water repels away from tires and car.
  - 6 tiles per pack. UV protected. Wt. 17 lbs.
- |                 |       |
|-----------------|-------|
| 009-25874 Black | 39.99 |
| 009-25875 Grey  | 39.99 |

**Get the Latest Price Online**

### C. new Craftsman Trim Kit

- Gives flooring a professional, finished look.
  - 14 beveled edge borders and 4 beveled edge corners included in each kit. Wt. 5.5 lbs.
- |                 |       |
|-----------------|-------|
| 009-02578 Beige | 29.99 |
| 009-25862 Black | 29.99 |
| 009-25863 Grey  | 29.99 |

**Get the Latest Price Online**

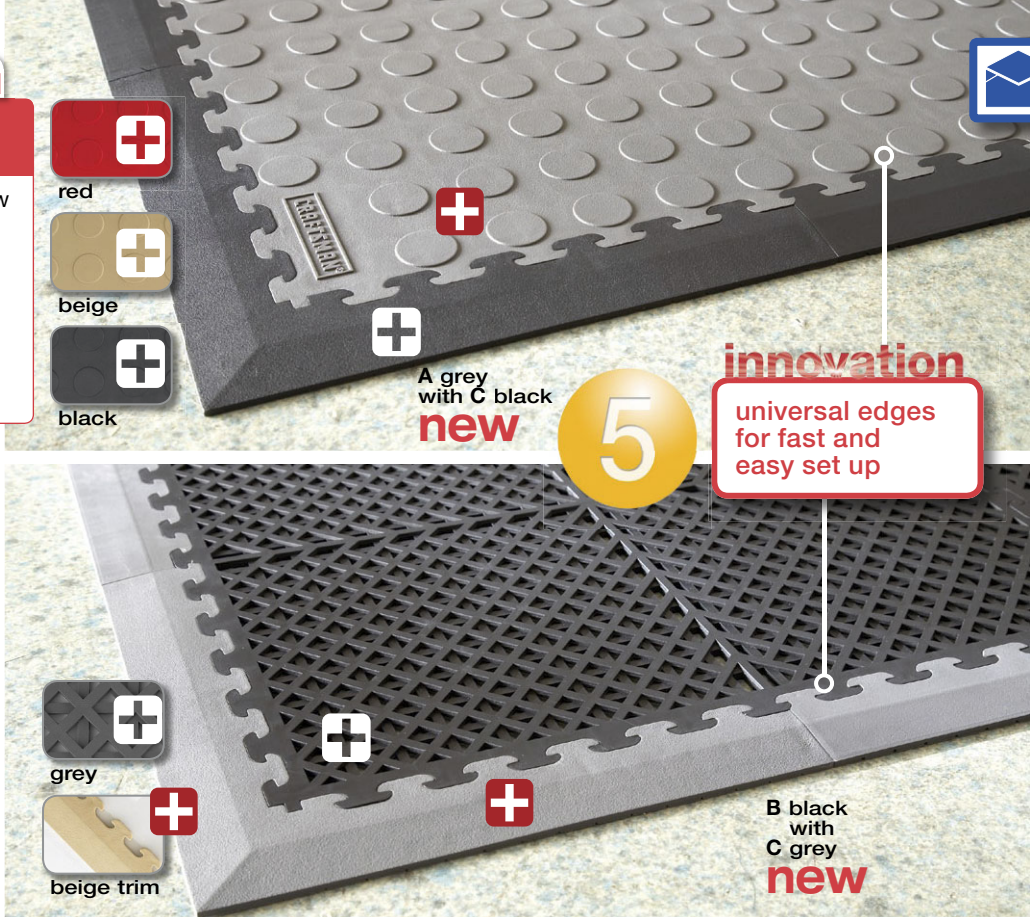

**innovation**

universal edges for fast and easy set up

5

A grey with C black new

B black with C grey new

# TRUSTED QUALITY

## Craftsman® flooring products



### D. new Craftsman Garage Tiles

- Professional-grade flooring designed to protect your garage floor from oil, grease and chemicals.
  - Each tile is 12 x 12 x 1/2 in.; 40 per box.
  - One box covers 40 sq. ft. Wt. 32 lbs.
- |                    |        |
|--------------------|--------|
| 009-61017 Red      | 109.99 |
| 009-61015 Black    | 109.99 |
| 009-61016 Platinum | 109.99 |
| 009-61018 Beige    | 109.99 |

**Get the Latest Price Online**

### Craftsman Trim Kit

- **Lock 3-Inch Edge (10-Pack)** Wt. 1.5 lbs. 14.99
- **Loop 3-Inch Edge (10-Pack)** Wt. 1.5 lbs. 14.99
- **Lock and Loop 3-Inch Edges with Corners (2 of each)** Wt. 1.5 lbs. 5.99

**Get the Latest Price Online**

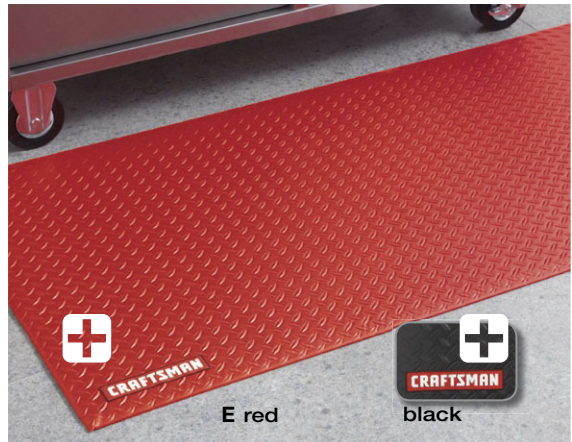
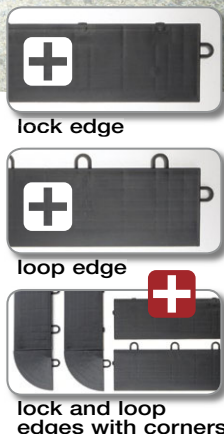

### E. Craftsman Anti-Fatigue Shop Mat

- Comforts feet, legs, and back while standing.
  - Prevents slipping and falling object damage.
  - Use it in workshops, garages, utility rooms, laundry rooms, art studios and more.
  - 30 x 60 in. Wt. 8.15 lbs.▼
- |                 |       |
|-----------------|-------|
| 009-12948 Red   | 39.99 |
| 009-22617 Black | 39.99 |

**Get the Latest Price Online**

\*Warranted, see page 112.  
 ♦ See "N" suffix note on page 112.  
 ▼ Accessories/props not included.

latest price online



# ACCESSORIES FOR YOUR MANCAVE

Craftsman® helps complete the scene



**F. Craftsman Rolling Mechanic's Seat with Onboard Tool Tray**

- Designed for comfort and convenience.
- 14-in. padded seat features rotating vinyl cushion, chrome accents and sturdy frame.
- Includes hydraulic seat adjustment (lift height of 16 to 21 in.), five 3-in. casters (two locking) and 17-in. steel tool tray with 5 removable trays. Warranted.\* Wt. 22.5 lbs.▼

009-51828 **79.99**  
[Get the Latest Price Online](#)



**H. Craftsman High Back Hydraulic Seat**

- Padded, 360-degree swivel seat with unique wrench-design back rest.
- Stool features high-polished chrome frame and footrest with heavy-duty hydraulic cylinder to adjust height from 28 1/2 to 33 in.
- Non-slip, self-leveling feet. Wt. 21 lbs.

009-52833 **99.99**  
[Get the Latest Price Online](#)

Catalog/Online EXCLUSIVE  
**G. Craftsman® 5-Piece Barbecue Gift Set with Bottle Opener**

- Utensils are stainless steel with contoured Craftsman, tool-style grips.
- Set includes BBQ fork, brush, turner, tongs and bottle opener. Wt. 2.38 lbs.

009-41656 **29.99**  
[Get the Latest Price Online](#)



**INCLUDES BOTTLE OPENER**

Catalog/Online EXCLUSIVE  
**J. Craftsman Hydraulic Stools**

- Craftsman style with seat back adjustable from 9.6 to 11.2 in.
- Hydraulic cylinder adjusts seat height from 28 1/2 to 33 in.
- Swivels 360 degrees; features non-slip adjustable feet for leveling.
- Six colors available online or in this catalog. Wt. 17.3 lbs.

009-82598 Neon Orange	<b>79.99</b>
009-52832 Yellow	<b>79.99</b>
009-82941 Red	<b>79.99</b>
009-52828 Blue	<b>79.99</b>
009-61828 Black	<b>79.99</b>
009-52830 Green	<b>79.99</b>

[Get the Latest Price Online](#)

**K. Craftsman High Top Table**

- Black vinyl-coated table features classic Craftsman logo.
- High-polished, chrome-finished center post; five-star legs with non-slip feet.
- Includes 4-piece coaster set. Wt. 22 lbs.▼

009-52590 **99.99**

**L. Craftsman Coasters**

- Set of four. Wt. 1 lb.

009-52591 **9.99**  
[Get the Latest Price Online](#)



**HYDRAULIC STOOLS IN SIX COLORS!**



**garage storage**

\*Warranted, see page 112.  
 ▼ Accessories/props not included.

Black stool available in stores.



# ORGANIZE YOUR STUFF, MAXIMIZE YOUR SPACE

**CRAFTSMAN®**

**versatrack™**

**Step**

**1 EMPTY IT OUT**

Get your things in categories, tools big and small.

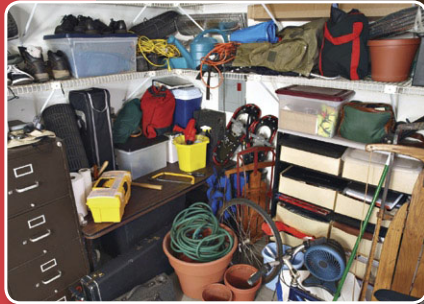

**Step**

**2 SET A GOAL**

Plan it. Go to the garage planner at [www.craftsman.com](http://www.craftsman.com) and get inspired.



**Step**

**3 GET THE GEAR**

The tracks.  
The shelves.  
The hooks.  
The components.



**CRAFTSMAN®  
VERSATRACK™  
WALL SYSTEM  
& ACCESSORIES**

- Flexible organization
- Install over drywall or masonry
- Secure accessories with the turn of a knob

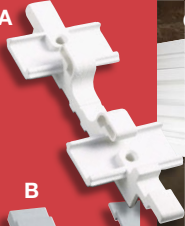

**A. Craftsman®  
VersaTrack™ Joiners**  
• Includes four joiners for seamless end-to-end connection. Wt. 1 lb.  
009-10125 9.99  
**Get the Latest Price Online**

**B. Craftsman  
VersaTrack™ End Caps**  
• Includes four end caps for a finished look. Wt. 1.6 lbs.  
009-10128 9.99  
**Get the Latest Price Online**

**C. Craftsman  
VersaTrack™ Trackwall**  
• Easy to install with two #10 (5mm) flathead screws (not included).  
• Can cut to shorter lengths.  
• 48W x 5 1/2H in. Wt. 3 lbs.  
009-10124 9.99  
**Get the Latest Price Online**





Share

garage storage



**VERSATILE TRACK SOLUTIONS**

single track

holds pegboard

**CRAFTSMAN VERSATRACK™ ACCESSORIES**

Description	Tips	Width	Catalog No.	Price	Description	Tips	Width	Catalog No.	Price
<b>D. Shelf Bracket</b>	Holds shelf above trackwall, leaving storage below shelf; holds "E" wire shelf or 10" wood or laminate shelf	3 1/2 in.	009-14895	\$7.99	<b>K. Narrow Basket</b>	Fill with aerosol cans, bottles, rags, gloves	11 in.	009-10100	12.99
<b>E. Wire Shelf</b>	Use with "D" shelf bracket; two brackets support one shelf or three brackets support two shelves	22 1/2 in.	009-14900	5.99	<b>L. Large Hook</b>	Use for extension cords, garden hoses	7 3/4 in.	009-10102	9.99
<b>F. Vertical Bike Hook</b>	Suspend most 12" to 26" bikes	4 3/8 in.	009-14898	8.99	<b>M. Outdoor Power Tool Hook</b>	Use with lawn trimmers, leaf blowers, hedge trimmers	4 in.	009-10129	13.99
<b>G. Horizontal Bike Hook</b>	Store most 12" to 26" bikes (two hooks needed)	3 1/2 in.	009-14897	9.99	<b>N. Long General Purpose Hook</b>	Hang garden equipment, strollers	4 in.	009-10119	7.99
<b>H. Ball Organizer</b>	Three detachable sections hold golf balls to basketballs	12 3/8 in.	009-01490	29.99	<b>P. Ladder Hook</b>	Hang step stools or extension ladders; use two hooks for horizontal ladder	4 in.	009-14896	9.99
<b>J. Short General Purpose Hook</b>	Store lawn equipment, axes, sledge hammers, lawn chairs	3 1/2 in.	009-10118	6.99	<b>Q. Curved Pivot Hook</b>	Hang long-handled tools	3 5/8 in.	009-10108	5.99
					<b>R. Standard Double Hook</b>	Organize sporting equipment and toys	3 1/2 in.	009-10117	7.99

Get the Latest Price Online

**NOW SEE THE COMPONENTS, TURN THE PAGE...**



Step

# 4 PULL IT ALL TOGETHER!

The final step to recreate, organize, and complete your transformation.

# CRAFTSMAN®

- Storage units.
- Coordinated shelves.
- Cabinets.
- Workbenches.
- Tool Storage.

SEE VIDEO  
at sears.com/shoptools

# COORDINATED, OR

A redesigned workspace



### CRAFTSMAN® SHELVING

- Industry-leading load rating of 1,000 lbs. per shelf (5,000 lbs. per unit).
- Reversible side brackets mount upward to keep items contained or downward to store extra-wide items.
- Steel construction is resistant to humidity and most household chemicals.

See page 108 for information on the Craftsman VersaTrack™ trackwall system or visit [craftsman.com](http://craftsman.com)

Accessories/props not included.



# ORGANIZED AND DONE!

Can be customized to your needs



garage storage



**H and J. new**

Craftsman® 9-Drawer Basic Ball-Bearing Tool Chest

- Ball-bearing drawer slides support 25 lbs. of tools per drawer.
- 4 x 2-in. casters support up to 500 lbs.
- Keyed lock and lock bar secure property.

**H. Craftsman 5-Drawer Basic Ball-Bearing Top Chest**

3,767 cu. in. capacity. Wt. 37 lbs.  
009-25911 Black 129.99  
**Get the Latest Price Online**

**J. Craftsman 4-Drawer Basic Ball-Bearing Bottom Chest**

8,306 cu. in. capacity. Wt. 64 lbs.  
009-25912 Black 189.99  
**Get the Latest Price Online**



Accessories/props not included.

### 52-INCH WIDE TOOL CHESTS

A. Craftsman 48-Inch Wide Shelf	B. Craftsman Floor Cabinet	C. Craftsman 36-Inch Wide Shelf	D. Craftsman Corner Shelf	E. Craftsman Wall Cabinet	F. Craftsman Workbench	G. Craftsman 5-Drawer Workbench Module
48W x 24D x 74H in.	32W x 18D x 74H in.	36W x 18D x 74H in.	45W x 35D x 74H in.	28W x 12D x 28H in.	72W x 24D x 41 1/4H in.	29 1/2W x 18D in.
1 fixed and 4 adjustable shelves Holds up to 1,000 lbs. per shelf 5,000 lb. load rating 5,760 cu. in. of storage Assembly required	1 fixed and 2 adjustable shelves Door latching system Keyed lock Large leveling feet Opening for power cords Assembly required	1 fixed and 4 adjustable shelves Holds up to 1,000 lbs. per shelf 5,000 lb. load rating 3,240 cu. in. of storage Assembly required	1 fixed and 4 adjustable shelves Holds up to 1,000 lbs. per shelf 18-in. deep shelves 5,000 lb. load rating 4,873 cu. in. of storage Assembly required	1 shelf Door latching system Opening for power cords Mounts directly to VersaTrack™, drywall or wall studs Assembly required	1 in. coated fiberboard top with banded edges Full-width backsplash Large leveling feet 1,450 lb. load rating Can be fitted with one or two "G" workbench modules Assembly required	5 ball-bearing drawers Drawer depth 16 1/2 in. Must be used with workbench "F" — can be mounted under either side Includes drawers, slides and one support leg Assembly required
009-14902 -Blk/Platinum 009-14903 -Red/Black	009-10140◆ -Blk/Platinum 009-10134◆ -Red/Black	009-14901 -Blk/Platinum 009-14907 -Red/Black	009-14904 -Blk/Platinum 009-14905 -Red/Black	009-10135 -Blk/Platinum 009-10131 -Red/Black	009-10138N◆ -Blk/Platinum 009-10132N◆ -Red/Black	009-10139 -Blk/Platinum 009-10133 -Red/Black
Wt. 93 lbs.	Wt. 126 lbs.	Wt. 63 lbs.	Wt. 90 lbs.	Wt. 45 lbs.	Wt. 100 lbs.	Wt. 63 lbs.
<b>\$189.99</b>	<b>279.99</b>	<b>139.99</b>	<b>229.99</b>	<b>149.99</b>	<b>219.99</b>	<b>199.99</b>

**Get the Latest Price Online**

shopyourway rewards join now. earn today. it's free. 111

◆ See "N" suffix note on page 112.



## KNOW WHAT YOU WANT?

Go to [sears.com/quickorder](http://sears.com/quickorder), enter the item number and click Go.

To find the Sears store nearest you,

Call 1-800-383-4814.

Most items available through

February 29, 2012.

## BUY ONLINE, PICKUP IN-STORE.

If your item isn't ready within five minutes of scanning your receipt, you will receive a \$5 coupon good toward your next in-store purchase.

Go to [sears.com](http://sears.com) for details.

# shopyourway rewards®

join now. earn today. it's free.

See details below.

## CONVENIENT DELIVERY OPTIONS

### Mailable Items: "Right-to-You" Delivery Service

We'll send all items that can be shipped by U.S. Mail or UPS to your home, workplace or anywhere you tell us when you place your order (except outside the U.S.) with any of our credit card options.

### Sears Catalog shipping charges

Total Order Weight (lbs.)	UPS Ground	Two Day Air	Overnight	APO/FPO
0.01 - 1.00	\$6.95	\$10.70	\$15.70	\$6.25
1.01 - 2.00	\$6.95	\$10.70	\$20.70	\$6.25
2.01 - 3.00	\$6.95	\$12.70	\$25.70	\$6.25
3.01 - 5.00	\$6.95	\$12.70	\$25.70	\$6.25
5.01 - 10.00	\$8.20	\$16.70	\$35.70	\$7.50
10.01 - 15.00	\$9.65	\$23.20	\$45.70	\$8.95
15.01 - 20.00	\$10.65	\$25.70	\$50.70	\$9.95
20.01 - 25.00	\$12.50	\$31.00	\$58.50	\$11.25
25.01 - 30.00	\$13.95	\$36.00	\$66.00	\$12.95
30.01 - 35.00	\$15.50	\$41.00	\$73.50	\$14.50
35.01 - 40.00	\$17.50	\$46.00	\$81.00	\$16.50
40.01 - 45.00	\$18.95	\$51.00	\$88.50	\$17.95
45.01 - 50.00	\$19.95	\$56.00	\$96.00	\$18.95
50.01 - 60.00	\$22.45	\$66.50	\$111.50	\$20.95
60.01 - 70.00	\$24.45	\$76.50	\$126.50	\$22.95
70.01 - 80.00	\$37.45	\$81.50	\$141.50	-
80.01 - 90.00	\$46.45	\$96.50	\$161.50	-
90.01 - 100.00	\$48.45	\$101.50	\$171.50	-
100.01 - 125.00	\$56.95	\$142.00	\$232.00	-
125.01 - 150.00	\$66.95	\$192.00	\$280.00+	-
		\$0.36 per lb.		
150.01 & above	\$64.95+	\$190.00+	\$280.00+	-
	\$0.36 per lb.	\$0.36 per lb.	\$0.36 per lb.	
<b>"Best Way" Truck Rates</b>				
		Premium	Standard	
0.01 - 100.00	-	\$179.00	\$90.00	-
100.01 - 200.00	-	\$150.00+	\$80.00+	-
		\$0.55 per lb.	\$0.33 per lb.	
200.01 & above	-	\$150.00+	\$75.00+	-
		\$0.55 per lb.	\$0.55 per lb.	

## FOR ITEMS WEIGHING MORE THAN 150 LBS.

There will be an additional charge of \$0.36 for each pound.

Residents of Alaska and Hawaii will be charged an additional fee (depending on weight) for shipping and handling on mailable items. We do not ship non-mailable items to Alaska, Hawaii, Puerto Rico, Guam or the Virgin Islands. An additional delivery charge may be quoted when you place your order for odd-shaped items. These items are shipped by common carrier and are curb service. A person 18 years or older must be available to meet the delivery and sign for the product(s). Our threshold delivery service is available for business and residential. The driver will place your purchases at the threshold door or in your garage. This service does not include in-home delivery or set-up. Ask your Customer Care Representative for details. Rates subject to change without notice.

## NEED IT FAST? Choose Expedited or Premium Shipping

We'll prepare your "credit-approved" mailable order so you'll receive it via expedited or premium delivery at your home or workplace. Does not apply to out-of-stock items. Ask your Customer Care Representative for details.

## "N♦" Note - Non-Mailable Items

Not available for Alaska, Hawaii, Puerto Rico, Guam or the Virgin Islands. Odd shapes and heavier items may not be eligible for standard delivery. We've designated these items with numbers ending in "N♦" (for example 009-59169N♦). Delivery charges and service vary by area. Ask your Customer Care Representative about "N♦" note items.

## FOR YOUR SAFETY

Always read and follow the operating and safety instructions provided in the owner's manual when using laser bench or power tools. Always wear safety goggles and other appropriate safety items recommended for protection.



**DANGER** Laser Radiation. Do not stare into beam or view directly with optical instruments. Max. Output: <5mW. Wavelength: 650Nm. Complies with 21 CFR 1040.0 and 1040.11. Class IIIa Laser Product.



**CAUTION** Laser Radiation. Do not stare into beam or view directly with optical instruments. Max. Output: <1mW Diode Laser 630-670Nm. Complies with 21 CFR 1040.0 and 1040.11. Class II Laser Product.



**CAUTION** Laser Radiation. Do not stare into beam or view directly with optical instruments. Max. Output: <2.5mW Diode Laser 630-670Nm. Complies with 21 CFR 1040.0 and 1040.11. Class II Laser Product.

## YOUR PRIVACY

Sears Catalog may share limited order information, such as our mailing lists and your summarized transactions, with carefully screened third-parties whose products or services may interest you. If you prefer to have your information withheld, or would like to stop receiving our specialty catalogs, please write us at: Sears Catalogs, List Maintenance-Privacy, P.O. Box 9145, Des Moines, IA 50306-9145.

## CATALOG TERMS OF SERVICE

Sears does not guarantee that the information in this catalog does not contain errors, inaccuracies or omissions. Such errors, inaccuracies or omissions may relate to pricing, product description, and/or availability. Sears reserves the right to correct any error, inaccuracy or omission or to update content without prior notice to you.

## SEARS PRICE MATCH PLUS POLICY

**Retail Competitors:** If you find a lower price on an identical branded item with the same features (in Home Electronics identical brand and model number) currently available for sale at another local competitor's retail store, Sears will match that price plus give you 10% of the difference. Just bring in the original advertisement to a sales associate at the time of, or within 14 days after, your purchase.

**Online Retail Competitors:** If you find a lower online price (including shipping, handling and delivery) on an identical branded item with the same features (in Home Electronics identical brand and model number) currently available from a local competitor retail store honoring its own online price and the item is currently available for sale and delivery in your area, Sears will match that total price plus give you 10% of the difference. Just print the ordering page, including shipping, handling and delivery, and bring it to your Sears store at the time of, or within 14 days after, your purchase. If you are purchasing the item from sears.com, email the information to [order@sears.com/pricematch](mailto:order@sears.com/pricematch).

**Sears Holdings:** If you find a lower price on an identical item (brand and model number) currently available for sale and delivery in your area from another Sears Holdings retail format or website, Sears will match that price, but will not provide the additional 10% of the difference. Sears will not price match limited time "Online Only" events, "Special Online Price" or conditional "Online Only Special Offers" on our websites. Only items listed as Sold by Sears or Sold by Kmart are eligible for price matching on our websites. All other rules for qualification apply.

**Exclusions:** Sears will not price match competitors' items that are limited in quantity, offered for sale for less than six hours during a day, or offered for sale during the day after Thanksgiving. Sears will not price match competitors' or our websites bonus or free offers, special offers, bundled offers, rebates, financing offers, coupons, clearance or closeout prices, or prices on used, damaged, returned, open box or display merchandise. Sears will not price match services. Sears will not match typographical errors or competitors' prices that result from a price match. Photo copies of advertisements or receipts will not be accepted as verification of competitor pricing. For other exclusions and further details see store associates or [sears.com/pricematch](http://sears.com/pricematch).

## Personalize it!

When you see this icon, it means you can imprint a name, initials, slogan or saying on selected Craftsman products. Choose up to 2 lines of 12 characters each and call 1-800-377-7414 to order with our customer representative. **Personalized Warranty** Personalized Craftsman Mechanic's Tools are covered under the lifetime warranty pledge and will be replaced according to standard policy terms and conditions. Any replacement product, however, will not be personalized.

## OUT OF STOCK/SUBSTITUTION POLICY

If an item is out of stock, we'll tell you when you place your order. If we don't think we can fill the order within 30 days, we'll ask if you still want the item when it becomes available. In some cases, we may offer a substitute of equal or greater value at the same price as your original order. If a substitute is not available and additional stock cannot be obtained, we will let you know that we will cancel your order. We reserve the right to limit quantities to properly serve all our customers.

## SATISFACTION GUARANTEED OR YOUR MONEY BACK

We hope that you are completely satisfied with your order. If for any reason you are not satisfied, return your order using the return label within 90 days for full refund. Shipping and handling charges are not refundable. Deductions on multiple savings items are subject to reduction if merchandise is returned. To return non-mailable items, just call our Customer Service line at 1-800-377-7414 to arrange for pick-up.

## SHOP YOUR WAY REWARDS

Members earn Points on Qualifying Purchases, excluding sales taxes and other fees. Subject to full program terms available at [shopyourwayrewards.com](http://shopyourwayrewards.com). Must maintain a valid email address and remain opted-in to receiving promotional emails from Shop Your Way Rewards to earn Bonus Points.

## WARRANTY INFORMATION

### Lifetime Warranty/Craftsman Hand Tool Full Warranty:

If any Craftsman hand tool ever fails to provide complete satisfaction, it will be repaired or replaced free of charge. This warranty excludes precision torque wrenches and calipers, which are covered under separate warranties. For warranty coverage details to obtain free repair or replacement, visit the web site: [craftsman.com](http://craftsman.com). This warranty gives you specific legal rights, and you may also have other rights which vary from state to state. Sears Brands Management Corporation, Hoffman Estates, IL 60179.

**Craftsman Tools Covered by Limited Warranties.** There are other Craftsman tools that are covered by a limited warranty instead of the Hand Tool warranty. Under these limited warranties, non-industrial-rated products are not warranted for commercial use. If you'd like a free copy of the warranty before you order, state the catalog item number, page number, and a description of the item. Mail requests to: Sears Power & Hand Tools Catalog, Customer Service/Warranties, P.O. Box 9145, Des Moines, IA 50306-9145.

### Lifetime Warranties.

A lifetime warranty covers the length of time you own the product.

## HOME SERVICES LICENSING INFORMATION:

★ The following licenses are held by or on behalf of Sears Home Improvement Products, Inc.: AL (Res. Bldr. #1062; HVAC #8186); AZ (Res. Remodeler #ROC117628 B-03; HVAC #ROC206649 C-39R; Dual Res. & Small Comm. #ROC260459 KB-02); AR (Gen. Bldg. Contr. #203740611-B, HVACR #1004181-B); CA (Gen. Bldg. Contr. #721379-B; Insulation & Acoustical #721379-C2, Cabinet, Millwork & Finish Carpentry #721379-C6, Flooring #721379-C15, Glazing #721379-C17, HVAC #721379-C20, Roofing #721379-C39, Ceramic & Mosaic Tile Cont. #721379-C54; Weatherization & Energy Conservation #721379-D65); CT (HTG, Piping & Cooling Un-Ltd. Cont. #HTG.0400133-S1; HIC #0607669); FL (Gen. Contr. #CGC012538; HVAC #CMC1249510, Certified Roofing Cont. #CCC1329316); GA (HVAC #CR109873); ID (HVAC #C-6134, Contracting Bus. #RCE-25219); IL (City of Chicago Home Repair #1248977); IN (Evansville Res. Remodeling Cont. #RRCO185); IA (Master HVAC #677); KY (Master HVAC #HM04667); LA (Res. Bldr. #84194; HVAC#45862); NV (HIC #87854; HVAC #6528; Contractor/Salesman #46542; HVACR #75581); MA (HIC #148607, All plumbing and electrical services performed by licensed subcontractors); MI (Res. Bldr. #2102131369; HVAC #7100915); MN (Res. Remodeler #20090017); MS (Res. Bldr. #R05222); NV (Carpentry #43242-C3; Gen. Contr. #60609-B; Plumb. & Htg. Contr. #60610-C1; Refrig. & AC Contr. #60608-C21; Gen. Serviceman #51469; HVAC #A0072; Roofing & Siding #43240-C15); NY (NYC HIC #1225166, Nassau County HIC #11809170000, Rockland County HIC #9990, Suffolk County #41506-H, Westchester County WC #18371-H06, Putnam County #3189-A, City of Yonkers #4213); NM (Gen. Bldg. Contr. #GB 98 58598; HVAC #MM98 52598; Elec. #EE-98 58598, MHD HVAC #MM98 C58598, MHD Elec. #EE98 C-58598); NC (Bldg. Limited. #47330; HVAC #15343 H-2, H-3-1, HVAC #30249 H-3-II); OH (HVAC #44752); OK (HVAC #106841); OR (Gen. Contr. #113202); PA (HI Contractor #PA005499); RI (Res. Contr. #27281, HVAC #6260); SC (Gen. Contr. #105836-BD5; HVAC Res. #RBH-919; Mechanical Contractor #110634); TN (HIC #2319; HVAC-Unlimited Contr. #54995; Res. & Small Comm-Unlimited BC-A #54995); TX (HVAC Dallas #TACLBO0020401E, Houston #TACLBO0028404E, Lubbock #TACLBO0027780E; San Antonio #TACLBO0029020); UT (Gen. Bldg. Contr. #B-100318604-5501; HVAC #S-350 318604-5501); VA (Class A Contr. #27-0584717; HVAC #2710046587); WA (Gen. Contr. #SEARSHI011LA); Washington, DC (HIC #50006423); WV (Res. Bldr., #WV025882, HVAC WV025882); WI (Dwelling Contr. Cert. #15151; Dwelling Contr. Qualifier #982570; HVAC Contractor #15151).

Some services performed by Sears associates. Other services and installation performed by Sears-Authorized licensed contractors; additional Sears license information available upon request.



# CRAFTSMAN®

## OPEN STOCK AND ACCESSORIES

The Professional's Companion  
to the 2011-2012 Annual Edition



[sears.com/shoptools](http://sears.com/shoptools)

1-877-4BLUCRW (425-8279)



**Craftsman® Locking Flex Ratcheting Wrenches**

Size	Catalog No.	Wt. lbs.	Price
5/16 in.	009-42470	0.11	\$19.49
3/8 in.	009-42471	0.20	19.99
7/16 in.	009-42472	0.24	21.49
1/2 in.	009-42473	0.30	21.99
9/16 in.	009-42474	0.39	22.99
5/8 in.	009-42475	0.52	23.99
3/4 in.	009-42476	0.77	26.49
8 mm	009-42477	0.11	18.99
10 mm	009-42478	0.20	19.99
12 mm	009-42479	0.27	21.99
13 mm	009-42480	0.30	23.49
15 mm	009-42481	0.45	25.49
17 mm	009-42482	0.64	26.49
19 mm	009-42483	0.79	28.49

**Craftsman® Locking Flex Stubby Wrenches**

Size	Catalog No.	Wt. lbs.	Price
5/16 in.	009-42484	0.08	\$19.49
3/8 in.	009-42485	0.14	19.99
7/16 in.	009-42486	0.19	21.49
1/2 in.	009-42487	0.25	21.99
9/16 in.	009-42488	0.31	22.99
5/8 in.	009-42489	0.44	23.99
3/4 in.	009-42490	0.56	26.49
8 mm	009-42491	0.06	18.99
10 mm	009-42492	0.13	19.99
12 mm	009-42493	0.19	21.99
13 mm	009-42494	0.25	23.49
15 mm	009-42495	0.38	25.49
17 mm	009-42496	0.44	26.49
18 mm	009-42497	0.50	27.49



**locking flex,  
dual, full polish,  
elbow, cross-force &  
open-end ratcheting**



**Craftsman® Universal Combination Ratcheting Wrenches**

Size	Catalog No.	Wt. lbs.	Price
5/16 in.	009-20584	0.13	\$11.49
3/8 in.	009-20601	0.19	12.49
7/16 in.	009-20602	0.25	12.99
1/2 in.	009-20609	0.31	13.49
9/16 in.	009-02061	0.38	13.99
5/8 in.	009-20612	0.44	14.99
11/16 in.	009-20613	0.56	15.99
10 mm	009-20583	0.19	12.49
11 mm	009-20614	0.25	12.99
12 mm	009-20615	0.25	13.49
13 mm	009-02062	0.31	13.99
14 mm	009-20621	0.38	14.99
15 mm	009-02063	0.44	15.49
17 mm	009-02064	0.56	16.49

**Craftsman® Cross-Force® Ratcheting Wrenches**

Size	Length, in.	Catalog No.	Wt. lbs.	Price
3/8 in.	6.5	009-43730	0.19	\$21.49
7/16 in.	7.2	009-43731	0.25	22.99
1/2 in.	8.2	009-43732	0.31	23.49
9/16 in.	8.6	009-43733	0.38	24.49
5/8 in.	9.5	009-43734	0.50	25.49
11/16 in.	10	009-43735	0.56	26.49
3/4 in.	10.9	009-43736	0.69	27.49
10 mm	6.5	009-43737	0.19	21.49
12 mm	7.8	009-43738	0.25	24.99
13 mm	8.2	009-43739	0.31	24.99
14 mm	8.6	009-43740	0.38	25.99
15 mm	9.1	009-43741	0.44	26.99
17 mm	10	009-43742	0.56	27.99
18 mm	10.4	009-43743	0.69	28.99







# OPEN STOCK

### Craftsman® Open End Ratcheting Wrenches

Size	Catalog No.	Wt. lbs.	Price
5/16 x 3/8 in.	009-21929	0.22	\$9.99
7/16 x 1/2 in.	009-02193	0.35	10.99
9/16 x 3/8 in.	009-21930	0.44	11.99
11/16 x 3/4 in.	009-21931	0.60	12.99
8 x 10 mm	009-21932	0.22	9.99
13 x 14 mm	009-21933	0.35	10.99
15 x 16 mm	009-21934	0.44	11.99
17 x 19 mm	009-21935	0.60	12.99

### Craftsman® Dual Ratcheting Combination Wrenches

Size	Catalog No.	Wt. lbs.	Price
5/16 in.	009-14735	0.06	\$17.49
3/8 in.	009-14736	0.13	18.49
7/16 in.	009-14737	0.13	18.99
1/2 in.	009-14738	0.19	19.49
9/16 in.	009-14739	0.25	19.99
5/8 in.	009-01474	0.38	20.49
11/16 in.	009-14740	0.44	20.99
3/4 in.	009-14741	0.56	21.49
8 mm	009-14743	0.07	17.49
10 mm	009-14745	0.13	18.99
12 mm	009-14747	0.19	19.49
13 mm	009-14748	0.19	19.99
14 mm	009-14749	0.25	20.49
15 mm	009-01475	0.31	20.49
17 mm	009-14751	0.44	21.99
19 mm	009-14753	0.56	22.99

# CRAFTSMAN®

# wrenches

# mechanic's tools

Sears' complete assortment of Craftsman ratcheting wrenches offers you innovative and flexible options to help solve problems of difficult access in tight spaces. Choose just the sizes you need to complete your collection.

### Craftsman® Elbow Ratcheting Wrenches

Size	Catalog No.	Wt. lbs.	Price
3/8 in.	009-14568	0.14	\$19.99
7/16 in.	009-14569	0.18	20.99
1/2 in.	009-14570	0.26	21.49
9/16 in.	009-14572	0.32	22.49
5/8 in.	009-14573	0.44	23.49
11/16 in.	009-14574	0.53	23.99
3/4 in.	009-14575	1.00	24.99
10 mm	009-14578	0.14	19.49
11 mm	009-14579	0.18	20.49
13 mm	009-14581	0.26	22.99
14 mm	009-14582	0.32	24.49
15 mm	009-14583	0.37	24.99
17 mm	009-14632	0.58	25.99
19 mm	009-14634	0.66	27.99

### Craftsman® Full Polish Reversible Ratcheting Wrenches

Size	Catalog No.	Wt. lbs.	Price
5/16 in.	009-42412	0.10	\$17.99
3/8 in.	009-42413	0.10	18.49
7/16 in.	009-42414	0.13	19.99
1/2 in.	009-42415	0.16	20.49
9/16 in.	009-42416	0.22	21.49
5/8 in.	009-42417	0.34	22.49
11/16 in.	009-42418	0.38	23.49
3/4 in.	009-42419	0.44	24.99
8 mm	009-42420	0.10	17.49
10 mm	009-42421	0.10	18.49
11 mm	009-42422	0.13	19.99
12 mm	009-42423	0.16	20.49
13 mm	009-42424	0.16	21.99
14 mm	009-42425	0.22	22.99
15 mm	009-42426	0.28	23.99
16 mm	009-42427	0.34	23.99
17 mm	009-42428	0.38	24.99
18 mm	009-42429	0.41	25.99
19 mm	009-42430	0.44	26.99



From the smallest to the largest, all Craftsman Full Polish wrenches are heat-treated, oil-quenched and tempered for hardness of strength. Choose from hundreds of sizes.

**full polish,  
box-end &  
open-end**

**Craftsman® Full Polish Wrenches**

**Long-Pattern Inch Combination Wrenches**

Size In./mm	Length In.	Catalog No.	Wt. lbs.	Price
1/4	4 7/8	009-45973	0.06	\$6.49
5/16	5 1/2	009-45974	0.09	6.79
3/8	6 3/8	009-45975	0.09	6.99
7/16	7 1/4	009-45976	0.13	8.49
1/2	7 7/8	009-45977	0.19	9.49
9/16	8 3/4	009-45978	0.25	10.49
5/8	9 5/8	009-45979	0.38	10.99
11/16	10 1/8	009-45980	0.44	11.99
3/4	10 7/8	009-45981	0.50	12.99
13/16	11 5/8	009-45982	0.56	13.99
7/8	12 3/8	009-45983	0.75	14.99
15/16	13 1/4	009-45984	0.94	16.99
1	13 7/8	009-45985	1.00	18.99
1 1/16	14 5/8	009-45950	1.25	22.99
1 1/8	15 3/8	009-45951	1.44	25.99
1 1/4	16 7/8	009-45952	1.75	29.49
1 5/16	18 3/8	009-45953	3.00	35.99
1 1/2	19 3/8	009-45954	3.50	39.99

**Long-Pattern Metric Combination Wrenches**

7	5 1/4	009-45986	0.06	\$6.99
8	5 3/4	009-45987	0.09	7.99
9	6	009-45988	0.09	8.29
10	6 5/8	009-45989	0.13	9.49
11	7 1/4	009-45990	0.13	9.99
12	7 5/8	009-45991	0.19	10.49
13	8 1/8	009-45992	0.19	10.99
14	8 5/8	009-45993	0.25	11.99
15	9	009-45994	0.31	11.99
16	9 1/2	009-45995	0.38	12.99
17	10	009-45996	0.38	13.99
18	10 1/2	009-45997	0.44	14.99
19	11	009-45998	0.50	15.99
21	11 7/8	009-45955	0.69	19.99
22	12 3/8	009-45956	0.81	22.99
23	12 3/4	009-45957	0.75	23.99
24	13 1/4	009-45958	0.88	26.99
25	13 7/8	009-45959	1.00	29.99
30	16 3/8	009-45960	1.50	36.99

**Craftsman® Full Polish Wrenches**

**Deep Offset (Inch) Box-End Wrenches 12-pt. openings**

Size In./mm	Length In.	Catalog No.	Wt. lbs.	Price
3/8 x 7/16	7 1/4	009-44316	0.13	\$10.99
1/2 x 9/16	8 5/8	009-44317	0.25	12.99
5/8 x 11/16	9 3/4	009-44318	0.44	14.99
3/4 x 7/8	11 1/2	009-44319	1.25	16.99
13/16 x 15/16	13 1/4	009-44320	1.38	19.99

**Deep Offset (Metric) Box-End Wrenches 12-pt. openings**

10 x 11	7 1/2	009-44360	0.13	\$10.99
12 x 14	8 5/8	009-44361	0.75	11.99
13 x 15	9 1/4	009-44362	0.88	13.99
16 x 18	9 7/8	009-44364	1.00	15.99
17 x 19	10 3/4	009-44366	1.00	16.99
20 x 22	11 3/4	009-44367	1.25	20.49
21 x 23	13 3/8	009-44368	1.38	21.99

**Stubby Inch Combination Wrenches**

5/16	3 1/4	009-44089	0.06	\$4.99
3/8	3 3/4	009-44103	0.06	5.99
7/16	4	009-44104	0.06	6.59
1/2	4 1/4	009-44105	0.13	7.29
9/16	4 1/2	009-44106	0.13	7.99
5/8	4 3/4	009-44107	0.19	8.79
11/16	5	009-44108	0.19	9.89
3/4	5 1/2	009-44109	0.25	10.49
13/16	5 3/4	009-44099	0.38	11.49
7/8	6 1/4	009-44100	0.44	12.39
15/16	6 1/2	009-44102	0.50	13.99
1	6 7/8	009-44110	0.56	15.49

**Stubby Metric Combination Wrenches**

9	3 1/2	009-44112	0.06	\$5.49
10	3 3/4	009-44113	0.06	6.29
12	4	009-44114	0.06	7.59
13	4 1/4	009-44115	0.13	8.29
14	4 5/8	009-44116	0.13	8.29
15	4 5/8	009-44117	0.13	8.59
16	4 7/8	009-44140	0.19	8.79
17	4 7/8	009-44118	0.19	9.79
18	5 1/8	009-44119	0.19	10.39
19	5 3/8	009-44120	0.25	10.49
20	5 5/8	009-44122	0.31	10.99
21	5 3/4	009-44124	0.31	11.49
22	6 1/4	009-44130	0.38	12.39



**CRAFTSMAN®** Share**OPEN  
STOCK**

# wrenches

**Craftsman® Open-End Wrenches****Standard Sizes**

Size In./mm	Length In.	Catalog No.	Wt. lbs.	Price
1/4 x 5/16	4 1/2	009-44571	0.05	\$4.99
3/8 x 7/16	5 3/16	009-44572	0.10	5.99
1/2 x 9/16	6 1/8	009-44579	0.20	6.99
9/16 x 5/8	7	009-44592	0.44	7.99
19/32 x 11/16	7	009-44581	0.31	8.49
5/8 x 3/4	7 13/16	009-44582	0.40	8.99
11/16 x 13/16	8 5/8	009-44591	0.50	9.99
25/32 x 13/16	10	009-44583	0.50	9.49
3/4 x 7/8	9 5/16	009-44584	0.50	10.49
15/16 x 1	10 21/32	009-44585	0.80	14.99
1 1/16 x 1 1/8	12	009-44586	1.13	19.99
1 1/4 x 1 5/16	14 11/16	009-44587	1.80	25.99
1 3/8 x 1 7/16	16 1/4	009-44588	2.56	31.49
1 1/2 x 1 5/8	17 9/16	009-44589	2.67	34.99

**Metric Sizes**

6 x 8	4 1/2	009-44502	0.10	\$4.99
7 x 9	5	009-44503	0.10	5.49
10 x 11	5 3/16	009-44504	0.13	5.99
12 x 14	6 3/16	009-44506	0.20	7.49
13 x 15	7	009-44507	0.25	7.99
16 x 18	7 3/4	009-44521	0.30	8.99
17 x 19	8 11/16	009-44508	0.38	9.49
20 x 22	9 1/2	009-44522	0.56	10.99
21 x 23	10 5/16	009-44523	0.69	11.99
22 x 24	10 5/16	009-44509	0.70	12.99
24 x 26	11 1/8	009-44515	0.81	13.99
25 x 27	11 7/8	009-44516	1.13	15.99
28 x 30	12 11/16	009-44518	1.13	17.99
30 x 32	13 1/2	009-44519	1.44	20.99

**Craftsman® Universal Combination Wrenches**

Size In./mm	Catalog No.	Wt. lbs.	Price
5/16	009-12959	0.08	\$6.29
3/8	009-12966	0.12	7.49
7/16	009-12953	0.17	7.99
1/2	009-12960	0.23	8.99
9/16	009-12967	0.31	9.99
5/8	009-12954	0.43	11.49
11/16	009-12961	0.53	12.49
10	009-12969	0.12	7.99
11	009-12956	0.17	8.49
12	009-12963	0.20	9.49
13	009-12970	0.23	9.99
14	009-12968	0.31	10.49
15	009-12964	0.37	10.99
17	009-12958	0.53	12.49

**Craftsman® Box-End Wrenches****Standard Sizes**

Size In./mm	Length In.	Catalog No.	Wt. lbs.	Price
3/8 x 7/16	4 3/4	009-43866	0.10	\$8.99
1/2 x 9/16	5 1/2	009-43864	0.20	9.99
5/8 x 3/4	6 3/8	009-43865	0.30	10.99
1/4 x 5/16	7 1/16	009-43919	0.13	7.99
3/8 x 7/16	7 3/4	009-43922	0.20	8.99
7/16 x 1/2	8 7/16	009-43921	0.25	8.99
1/2 x 9/16	9 1/8	009-43923	0.31	9.99
9/16 x 5/8	9 3/4	009-43924	0.40	10.99
19/32 x 25/32	10	009-43925	0.50	11.49
5/8 x 3/4	10 1/2	009-43926	0.44	11.99
11/16 x 13/16	11 7/8	009-43927	0.60	12.99
3/4 x 7/8	12 5/8	009-43928	0.66	15.99
15/16 x 1	15 3/8	009-43929	1.00	16.99
1 1/16 x 1 1/4	17 1/16	009-43934	1.40	25.99
1 1/8 x 1 5/16	18 11/16	009-43935	2.13	27.99
1 7/16 x 1 1/2	22 3/32	009-43936	2.50	29.99

**Metric Sizes**

6 x 8	7	009-42952	0.13	\$7.99
7 x 9	7 3/4	009-42953	0.19	8.49
10 x 11	7 7/16	009-42954	0.25	8.99
12 x 14	9 1/8	009-42956	0.31	9.99
13 x 15	9 13/16	009-42957	0.38	10.99
16 x 18	10 1/2	009-42961	0.38	12.49
17 x 19	11 3/16	009-42958	0.50	13.99
20 x 22	11 29/32	009-42965	0.63	14.99
21 x 23	12 11/16	009-42966	0.69	15.99
22 x 24	13 7/16	009-42959	0.81	16.99
24 x 26	14 1/8	009-44962	0.94	17.99
25 x 28	14 7/8	009-44963	1.00	18.99
27 x 30	15 5/8	009-44965	1.06	20.99
28 x 32	16 3/8	009-44966	1.19	21.99
30 x 32	17	009-44967	1.50	22.99

mechanic's tools



**Craftsman® 12-pt.  
Combination Wrenches**

Inch				
Size In.	Length In.	Catalog No.	Wt. lbs.	Price
1/4	3 15/16	009-44699	0.06	\$4.49
5/16	4 3/8	009-44691	0.06	4.99
11/32	4 13/16	009-44692	0.06	5.49
3/8	5 1/4	009-44693	0.06	5.99
7/16	5 13/16	009-44694	0.13	6.49
1/2	6 1/2	009-44695	0.19	7.19
9/16	7 3/16	009-44696	0.25	7.99
5/8	8	009-44697	0.31	8.99
11/16	8 25/32	009-44698	0.38	9.99
3/4	9 5/8	009-44701	0.63	10.99
13/16	10 9/16	009-44702	0.63	11.49
7/8	11 1/2	009-44703	0.69	11.99
15/16	12 1/2	009-44704	0.69	13.99
1	13 1/2	009-44705	1.00	15.99
1 1/16	14 5/8	009-44706	1.13	18.99
1 1/8	15 9/16	009-44707	1.13	21.99
1 1/4	16 7/8	009-44708	1.13	24.99
1 5/16	18 1/4	009-44709	2.00	26.99

**Craftsman® 12-pt.  
Combination Wrenches**

Metric				
Size mm	Length in.	Catalog No.	Wt. lbs.	Price
6	3 3/16	009-42909	0.06	\$4.79
7	3 3/16	009-42911	0.06	4.99
8	4 1/8	009-42912	0.06	4.99
9	4 3/8	009-42913	0.06	5.49
10	4 3/4	009-42914	0.13	6.19
11	5 3/8	009-42915	0.13	6.79
12	5 7/8	009-42916	0.19	7.49
13	6 1/16	009-42917	0.19	7.79
14	6 7/8	009-42918	0.25	8.29
15	7 13/16	009-42919	0.31	8.49
16	8	009-42924	0.31	8.99
17	8 13/16	009-42929	0.38	9.79
18	8 13/16	009-42925	0.38	10.29
19	9 1/2	009-42921	0.50	10.99
20	10 1/4	009-42937	0.50	11.49
21	10 7/8	009-42938	0.63	12.99
22	11 7/16	009-42922	0.70	13.59
23	12 1/8	009-42939	0.75	14.99
24	12 1/4	009-42923	0.90	15.99
25	13 1/2	009-42931	0.94	16.99
26	14 1/16	009-42932	1.00	17.99
27	14 5/8	009-42933	1.13	18.99
28	15 9/16	009-42934	1.69	19.99
30	16 1/4	009-42935	1.69	20.99
32	16 7/8	009-42936	1.81	25.99

**Craftsman® 6-pt.  
Combination Wrenches**

Inch				
Size In.	Length In.	Catalog No.	Wt. lbs.	Price
1/4	3 15/16	009-44381	0.06	\$4.49
5/16	4 3/8	009-44382	0.06	4.99
11/32	4 13/16	009-44399	0.06	5.49
3/8	5 1/4	009-44383	0.06	5.99
7/16	5 13/16	009-44384	0.13	6.49
1/2	6 1/2	009-44385	0.19	7.19
9/16	7 3/16	009-44386	0.25	7.99
5/8	8	009-44387	0.31	8.99
11/16	8 25/32	009-44388	0.38	9.99
3/4	9 5/8	009-44389	0.63	10.99
13/16	10 9/16	009-44390	0.63	11.49
7/8	11 1/2	009-44391	0.69	11.99
15/16	12 1/2	009-44392	0.69	13.99
1	13 1/2	009-44393	1.00	15.99

Unique jobs and special applications require the right tools. Sears offers a complete collection of Craftsman specialty wrenches for each unique challenge you face. From an obstruction wrench for working on manifolds and starters to Flare Nut wrenches to avoid rounding when working on aluminum, copper or brass fittings.

**Craftsman® 6-pt.  
Combination Wrenches**

Metric				
Size mm	Length in.	Catalog No.	Wt. lbs.	Price
6	3 3/16	009-42863	0.06	\$4.79
7	3 3/16	009-42864	0.06	4.99
8	4 1/8	009-42865	0.06	4.99
9	4 3/8	009-42866	0.06	5.49
10	4 3/4	009-42867	0.13	6.19
11	5 3/8	009-42868	0.13	6.79
12	5 7/8	009-42869	0.19	7.49
13	6 1/16	009-42870	0.19	7.79
14	6 7/8	009-42871	0.25	8.29
15	7 13/16	009-42872	0.31	8.49
16	8	009-42873	0.31	8.99
17	8 13/16	009-42874	0.38	9.79
18	8 13/16	009-42875	0.38	10.29
19	9 1/2	009-42876	0.50	10.99



### Craftsman® Specialty Wrenches

#### Tappet Wrenches. Inch

Size In./mm.	Length In.	Catalog No.	Wt. lbs.	Price
3/8 x 7/16	—	009-44475	0.16	\$10.79
7/16 x 17/32	—	009-44471	0.19	10.79
1/2 x 9/16	—	009-44472	0.22	10.99
5/8 x 11/16	—	009-44473	0.44	10.99
3/4 x 7/8	—	009-44474	0.44	11.79

#### Flare Nut Wrenches. Inch. Full Polish

1/4 x 5/16	4 1/3	009-42090	0.06	\$17.49
3/8 x 7/16	5 1/4	009-42091	0.11	17.99
1/2 x 9/16	6 1/4	009-42092	0.18	18.99
5/8 x 11/16	7 1/8	009-42093	0.30	19.49
3/4 x 7/8	7 1/2	009-42094	0.44	19.99

#### Flare Nut Wrenches. Metric. Full Polish

9 x 11	5	009-42095	0.10	\$17.99
10 x 12	5 1/2	009-42096	0.13	18.49
13 x 14	6 1/8	009-42097	0.18	18.99
15 x 17	6 3/4	009-42098	0.27	19.49
16 x 18	7 1/8	009-42099	0.29	19.99
19 x 21	7 3/4	009-42100	0.45	20.99

#### Obstruction Wrench. Inch

9/16 x 5/8	7 1/4	009-04376	0.40	\$16.99
------------	-------	-----------	------	---------

# OPEN STOCK

### Craftsman® 12-pt. Cross-Force® Wrenches

#### Metric

Size mm.	Length In.	Catalog No.	Wt. lbs.	Price
8	7 3/8	009-46530	0.313	\$10.99
10	7 1/2	009-46531	0.359	12.99
12	7 3/4	009-46532	0.443	14.49
13	8 3/8	009-46533	0.489	14.99
14	8 1/2	009-46534	0.535	16.49
15	9	009-46535	0.690	16.99
17	10	009-46536	0.917	18.99
18	10 5/8	009-46537	0.971	19.99
19	11	009-46690	0.700	22.99
20	11 1/4	009-46691	0.900	25.99
21	12	009-46692	1.000	27.99
22	12 1/2	009-46693	1.200	29.99
24	12 1/4	009-46694	1.400	31.99

# combination & specialty wrenches

## CRAFTSMAN®

### Craftsman® 12-pt. Cross-Force Wrenches

#### Inch

Size In.	Length In.	Catalog No.	Wt. lbs.	Price
5/16	7 1/4	009-46490	0.313	\$10.99
3/8	7 1/2	009-46491	0.359	12.99
7/16	7 5/8	009-46492	0.399	14.49
1/2	8 1/2	009-46493	0.489	14.99
9/16	8 5/8	009-46494	0.535	16.49
5/8	9 1/2	009-46495	0.802	16.99
11/16	10	009-46496	0.917	18.99
3/4	10 5/8	009-46497	1.035	19.99
13/16	11 3/4	009-46685	1.000	24.99
7/8	12 1/2	009-46686	1.200	26.99
15/16	13 1/4	009-46687	1.400	29.99
1	14	009-46688	1.700	31.99
1 1/8	15 3/4	009-46689	2.300	34.99

### Craftsman® Specialty Wrenches

#### Craftsman® 3/8-in. Drive Crowfoot Wrenches

Size	Catalog No.	Wt. lbs.	Price
3/8 in.	009-43611	0.06	\$6.99
7/16 in.	009-43621	0.06	6.99
1/2 in.	009-43622	0.06	6.99
9/16 in.	009-43623	0.06	6.99
5/8 in.	009-43624	0.13	6.99
11/16 in.	009-43625	0.13	7.99
3/4 in.	009-43626	0.13	7.99
13/16 in.	009-43627	0.13	7.99
7/8 in.	009-43628	0.19	7.99
15/16 in.	009-43588	0.25	7.99
1 in.	009-43629	0.25	7.99
10 mm	009-43631	0.06	6.99
11 mm	009-43632	0.06	6.99
12 mm	009-43633	0.06	6.99
13 mm	009-43634	0.06	6.99
14 mm	009-43635	0.06	6.99
15 mm	009-43636	0.06	7.99
16 mm	009-43637	0.13	7.99
17 mm	009-43638	0.13	7.99
18 mm	009-43639	0.13	7.99
19 mm	009-43641	0.13	7.99

mechanic's tools



# CRAFTSMAN®

# 3/4-inch drive & 1/2-inch dual-mark

## Craftsman® 3/4-inch Drive Inch Sockets

Regular-depth				
Size In.	Points	Catalog No.	Wt. lbs.	Price
7/8	12	009-47771	0.31	\$14.99
15/16	12	009-47772	0.31	14.99
1	12	009-47773	0.31	14.99
1 1/16	12	009-47774	0.31	14.99
1 1/8	12	009-47775	0.38	14.99
1 3/16	12	009-47776	0.44	14.99
1 1/4	12	009-47777	0.50	17.99
1 5/16	12	009-47778	0.56	17.99
1 3/8	12	009-47779	0.63	17.99
1 7/16	12	009-47781	0.69	17.99
1 1/2	12	009-47782	0.69	17.99
1 5/8	12	009-47783	0.88	19.99
1 11/16	12	009-47784	1.00	19.99
1 3/4	12	009-47785	1.13	19.99
1 13/16	12	009-47786	1.19	23.99
1 7/8	12	009-47787	1.38	23.99
2	12	009-47788	1.69	23.99
2 1/8	12	009-47789	1.88	26.99
2 3/16	12	009-47791	2.00	26.99
2 1/4	12	009-47792	2.13	26.99
2 3/8	12	009-47793	2.44	26.99

## Craftsman® 3/4-inch Drive Metric Sockets

Regular-depth				
Size mm	Points	Catalog No.	Wt. lbs.	Price
19	12	009-47926	0.3475	\$15.99
20	12	009-47927	0.3415	15.99
21	12	009-47928	0.3815	15.99
22	12	009-47929	0.4990	15.99
23	12	009-47930	0.4980	16.99
24	12	009-47931	0.4690	16.99
25	12	009-47932	0.5440	18.99
26	12	009-47933	0.5330	18.99
27	12	009-47934	0.5190	18.99
28	12	009-47935	0.5820	18.99
29	12	009-47936	0.5670	18.99
30	12	009-47937	0.5925	21.99
32	12	009-47938	0.7685	21.99
35	12	009-47939	0.8040	21.99
36	12	009-47940	0.7920	25.99
38	12	009-47941	0.7995	25.99
41	12	009-47942	0.8545	25.99
42	12	009-47943	0.8165	28.99

## Craftsman® 1/2-Inch Dual-Mark Sockets

Regular-depth (1/2-In. Inch Sockets)				
Size In.	Points	Catalog No.	Wt. lbs.	Price
3/8	6	009-45883	0.13	\$4.99
7/16	6	009-45884	0.13	4.99
1/2	6	009-45885	0.13	4.99
9/16	6	009-45886	0.13	4.99
5/8	6	009-45887	0.13	4.99
11/16	6	009-45888	0.25	4.99
3/4	6	009-45889	0.25	4.99
13/16	6	009-45890	0.25	4.99
7/8	6	009-45891	0.25	4.99
15/16	6	009-45892	0.31	5.69
1	6	009-50731	0.38	5.69
1 1/16	6	009-50732	0.38	6.89
1 1/8	6	009-50733	0.38	6.89
1 3/16	6	009-50734	0.44	7.69
1 1/4	6	009-50735	0.44	7.69
7/16	8	009-50739	0.13	5.69
1/2	8	009-50740	0.13	5.69
9/16	8	009-50741	0.13	5.69
5/8	8	009-50742	0.13	5.69
11/16	8	009-50743	0.19	5.69
3/4	8	009-50744	0.25	5.69
3/8	12	009-34039	0.13	4.99
7/16	12	009-34040	0.13	4.99
1/2	12	009-34041	0.13	4.99
9/16	12	009-34042	0.13	4.99
19/32	12	009-50745	0.13	4.99
5/8	12	009-34043	0.13	4.99
21/32	12	009-50746	0.13	4.99
11/16	12	009-34046	0.19	4.99
3/4	12	009-34652	0.19	4.99
25/32	12	009-50747	0.19	4.99
13/16	12	009-34653	0.25	4.99
7/8	12	009-34654	0.25	4.99
15/16	12	009-34655	0.31	5.69
1	12	009-34054	0.38	5.69
1 1/16	12	009-34057	0.38	6.89
1 1/8	12	009-34056	0.38	6.89
1 3/16	12	009-50748	0.44	7.69
1 1/4	12	009-45905	0.44	7.69
1 1/2	12	009-50749	0.75	8.49

## Craftsman® 1/2-Inch Dual-Mark Sockets

Regular-depth (1/2-In. Metric Sockets)				
Size mm	Points	Catalog No.	Wt. lbs.	Price
9	6	009-45893	0.13	\$4.99
10	6	009-45894	0.13	4.99
11	6	009-45895	0.13	4.99
12	6	009-45896	0.13	4.99
13	6	009-45897	0.13	4.99
14	6	009-45898	0.13	4.99
15	6	009-45928	0.13	4.99
16	6	009-50801	0.13	4.99
17	6	009-45929	0.13	4.99
18	6	009-45930	0.19	4.99
19	6	009-45931	0.19	5.69
20	6	009-50736	0.19	6.29
21	6	009-50737	0.25	6.29
22	6	009-50738	0.25	6.89
9	12	009-34061	0.13	4.99
10	12	009-34062	0.13	4.99
11	12	009-34063	0.13	4.99
12	12	009-34064	0.13	4.99
13	12	009-34065	0.13	4.99
14	12	009-34066	0.13	4.99
15	12	009-34067	0.13	4.99
16	12	009-34068	0.13	4.99
17	12	009-34661	0.13	4.99
18	12	009-34662	0.19	5.69
19	12	009-34663	0.19	5.69
20	12	009-34073	0.19	5.69
21	12	009-34664	0.25	5.69
22	12	009-34075	0.25	6.89
23	12	009-34076	0.25	6.89
24	12	009-34077	0.31	6.89
25	12	009-45923	0.31	6.89
26	12	009-50750	0.31	8.79
27	12	009-34081	0.38	8.79
28	12	009-45925	0.44	8.79
29	12	009-50751	0.44	8.79
30	12	009-45926	0.44	8.79
32	12	009-45927	0.44	8.79
36	12	009-50752	0.75	8.79





Share

# OPEN STOCK

# sockets



mechanic's tools

### Craftsman® 1/2-Inch Dual-Mark Sockets

#### Deep-depth (1/2-In. Inch Sockets)

Size In.	Points	Catalog No.	Wt. lbs.	Price
1/2	6	009-50753	0.25	\$7.49
9/16	6	009-45932	0.31	7.49
5/8	6	009-45933	0.31	7.49
11/16	6	009-45934	0.31	8.79
3/4	6	009-45935	0.31	8.79
13/16	6	009-45936	0.38	8.79
7/8	6	009-45937	0.38	10.69
15/16	6	009-50754	0.44	10.69
1	6	009-50755	0.50	10.69
1 1/16	6	009-50756	0.50	10.69
1 1/8	6	009-50757	0.63	10.69
7/16	12	009-34582	0.20	7.49
1/2	12	009-50758	0.25	7.49
9/16	12	009-50759	0.25	7.49
5/8	12	009-50760	0.25	7.49
11/16	12	009-50761	0.31	8.79
3/4	12	009-50762	0.31	8.79
13/16	12	009-50763	0.38	8.79
7/8	12	009-50764	0.56	10.69
15/16	12	009-50765	0.56	10.69
1	12	009-50766	0.56	10.69
1 1/16	12	009-50767	0.56	10.69
1 1/8	12	009-50768	0.63	10.69
1 3/16	12	009-34583	0.70	10.69

### Craftsman® 1/2-Inch Dual-Mark Sockets

#### Deep-depth (1/2-In. Metric Sockets)

Size mm	Points	Catalog No.	Wt. lbs.	Price
12	6	009-44628	0.20	\$7.49
13	6	009-44629	0.25	7.49
14	6	009-44630	0.25	7.49
15	6	009-44631	0.31	7.49
16	6	009-44632	0.31	7.49
17	6	009-44633	0.31	7.49
18	6	009-44634	0.31	7.49
19	6	009-44635	0.31	7.49
21	6	009-44637	0.38	10.69
10	12	009-34584	0.15	8.79
11	12	009-34585	0.15	8.79
12	12	009-34586	0.15	8.79
13	12	009-45938	0.25	8.79
14	12	009-45939	0.25	8.79
15	12	009-45940	0.31	8.79
16	12	009-45941	0.31	8.79
17	12	009-45942	0.31	8.79
18	12	009-45943	0.31	8.79
19	12	009-50769	0.31	8.79
20	12	009-50771	0.38	8.79
21	12	009-50772	0.38	10.69
22	12	009-50773	0.38	10.69
24	12	009-50774	0.44	10.69
27	12	009-50775	0.56	10.69

#### Drag Link Sockets

Size In.	Catalog No.	Wt. lbs.	Price
9/16	009-44511	0.13	\$10.49
3/4	009-44512	0.13	10.49
15/16	009-44513	0.19	11.49
1 3/16	009-44514	0.25	13.99

Large and small, SAE and Metric, standard and deep, 6 and 12-point, in 3/4-inch and 1/2-inch drive sizes – these Craftsman sockets stand ready to provide you the rugged performance you've come to expect. Choose from hundreds of options to complete your tool set.



# CRAFTSMAN®

## Craftsman® 1/4-Inch Dual-Mark Sockets

### Regular-depth (1/4-in. Inch Sockets)

Size in.	Points	Catalog No.	Wt. lbs.	Price
5/32	6	009-45801	0.06	\$2.49
3/16	6	009-45802	0.06	2.49
7/32	6	009-34591	0.06	2.49
1/4	6	009-34592	0.06	2.49
9/32	6	009-34593	0.06	2.49
5/16	6	009-34594	0.06	2.49
11/32	6	009-34595	0.06	2.49
3/8	6	009-34596	0.06	2.49
7/16	6	009-34597	0.06	2.49
1/2	6	009-34598	0.06	2.49
9/16	6	009-34599	0.06	2.49
3/16	12	009-45803	0.06	2.49
7/32	12	009-45804	0.06	2.49
1/4	12	009-45806	0.06	2.49
9/32	12	009-45807	0.06	2.49
5/16	12	009-45808	0.06	2.49
11/32	12	009-45809	0.06	2.49
3/8	12	009-45811	0.06	2.49
7/16	12	009-45812	0.06	2.49
1/2	12	009-45813	0.06	2.49
9/16	12	009-45810	0.06	2.49

### Deep-depth (1/4-in. Inch Sockets)

3/16	6	009-45814	0.06	\$3.79
7/32	6	009-45815	0.06	3.79
1/4	6	009-34612	0.06	3.79
9/32	6	009-34613	0.06	3.79
5/16	6	009-34614	0.06	3.79
11/32	6	009-45816	0.13	3.79
3/8	6	009-34615	0.13	3.79
7/16	6	009-34616	0.13	3.79
1/2	6	009-45817	0.13	3.79
9/16	6	009-45818	0.13	3.79
3/16	12	009-50610	0.06	3.79
7/32	12	009-50611	0.06	3.79
1/4	12	009-50612	0.06	3.79
9/32	12	009-50613	0.06	3.79
5/16	12	009-50614	0.06	3.79
11/32	12	009-50615	0.06	3.79
3/8	12	009-50616	0.06	3.79
7/16	12	009-50617	0.13	3.79
1/2	12	009-50618	0.13	3.79
9/16	12	009-50619	0.13	3.79

## Craftsman® 1/4-Inch Dual-Mark Sockets

### Regular-depth (1/4-in. Metric Sockets)

Size mm	Points	Catalog No.	Wt. lbs.	Price
4	6	009-45907	0.06	\$2.49
5	6	009-45908	0.06	2.49
5.5	6	009-34601	0.06	2.49
6	6	009-34602	0.06	2.49
7	6	009-34603	0.06	2.49
8	6	009-34604	0.06	2.49
9	6	009-34605	0.06	2.49
10	6	009-34606	0.06	2.49
11	6	009-34607	0.06	2.49
12	6	009-34608	0.06	2.49
13	6	009-34609	0.06	2.49
14	6	009-34611	0.06	2.49

### Deep-depth (1/4-in. Metric Sockets)

4	6	009-45909	0.06	\$3.79
5	6	009-45911	0.06	3.79
6	6	009-45912	0.06	3.79
7	6	009-34621	0.06	3.79
8	6	009-34622	0.06	3.79
9	6	009-34623	0.06	3.79
10	6	009-34624	0.06	3.79
11	6	009-34625	0.13	3.79
12	6	009-45913	0.13	3.79
13	6	009-45914	0.13	3.79
14	6	009-45915	0.13	3.79

## Craftsman® 3/8-Inch Dual-Mark Sockets

### Regular-depth (3/8-in. Inch Sockets)

Size In.	Points	Catalog No.	Wt. lbs.	Price
1/4	6	009-45821	0.06	\$3.79
5/16	6	009-45822	0.06	3.79
3/8	6	009-45823	0.06	3.79
7/16	6	009-45824	0.06	3.79
1/2	6	009-45825	0.06	3.79
9/16	6	009-45826	0.06	3.79
5/8	6	009-45827	0.13	3.79
11/16	6	009-45828	0.13	3.79
3/4	6	009-45829	0.25	3.79
13/16	6	009-45831	0.25	3.79
7/8	6	009-45832	0.25	3.79
15/16	6	009-45833	0.31	3.79
1	6	009-45834	0.38	3.79
1/4	8	009-45790	0.13	3.79
5/16	8	009-45791	0.13	3.79
3/8	8	009-45792	0.13	3.79
7/16	8	009-45793	0.13	3.79
1/2	8	009-45794	0.13	3.79
1/4	12	009-34631	0.06	3.79
5/16	12	009-45901	0.06	3.79
3/8	12	009-34632	0.06	3.79
7/16	12	009-34633	0.06	3.79
1/2	12	009-34634	0.06	3.79
9/16	12	009-34635	0.06	3.79
5/8	12	009-34636	0.19	3.79
11/16	12	009-34637	0.19	3.79
3/4	12	009-34638	0.19	3.79
13/16	12	009-45902	0.19	3.79
7/8	12	009-45903	0.19	3.79
15/16	12	009-50650	0.25	3.79
1	12	009-50651	0.31	3.79



# 1/4-inch drive & 3/8-inch dual-mark sockets



**OPEN STOCK**

Craftsman Dual-Mark sockets in 1/4-inch and 3/8-inch drive sizes – complete your set with just the sizes you need. Metric or SAE, regular or deep, in 6 or 12-point sizes.

### Craftsman® 3/8-Inch Dual-Mark Sockets

#### Regular-depth (3/8-in. Metric Sockets)

Size mm	Points	Catalog No.	Wt. lbs.	Price
6	6	009-45847	0.06	\$3.79
7	6	009-45848	0.06	3.79
8	6	009-45849	0.06	3.79
9	6	009-45851	0.06	3.79
10	6	009-45852	0.06	3.79
11	6	009-45853	0.06	3.79
12	6	009-45854	0.06	3.79
13	6	009-45855	0.06	3.79
14	6	009-45856	0.06	3.79
15	6	009-45857	0.06	3.79
16	6	009-45858	0.13	3.79
17	6	009-45859	0.13	3.79
18	6	009-45861	0.13	3.79
19	6	009-45862	0.13	3.79
20	6	009-45863	0.19	3.79
21	6	009-45864	0.19	3.79
22	6	009-45919	0.19	3.79
6	12	009-50652	0.06	3.79
7	12	009-50653	0.06	3.79
8	12	009-50654	0.06	3.79
9	12	009-34639	0.06	3.79
10	12	009-34641	0.06	3.79
11	12	009-34642	0.06	3.79
12	12	009-34643	0.06	3.79
13	12	009-34644	0.06	3.79
14	12	009-34645	0.06	3.79
15	12	009-34646	0.06	3.79
16	12	009-34647	0.13	3.79
17	12	009-34648	0.13	3.79
18	12	009-34649	0.13	3.79
19	12	009-34651	0.13	3.79
21	12	009-45921	0.13	3.79

### Craftsman® 3/8-Inch Dual-Mark Sockets

#### Deep-depth (3/8-in. Inch Sockets)

Size In.	Points	Catalog No.	Wt. lbs.	Price
3/8	6	009-45835	0.19	\$4.99
7/16	6	009-45836	0.19	4.99
1/2	6	009-45837	0.19	4.99
9/16	6	009-45838	0.19	4.99
5/8	6	009-45839	0.25	4.99
11/16	6	009-45841	0.25	4.99
3/4	6	009-45842	0.25	6.29
13/16	6	009-45843	0.31	6.29
7/8	6	009-45844	0.38	6.29
15/16	6	009-45845	0.44	6.29
1	6	009-45846	0.50	6.29
3/8	12	009-50655	0.19	4.99
7/16	12	009-50656	0.19	4.99
1/2	12	009-50657	0.19	4.99
9/16	12	009-50658	0.19	4.99
5/8	12	009-50659	0.25	4.99
11/16	12	009-50660	0.25	4.99
3/4	12	009-50661	0.25	5.69
13/16	12	009-50662	0.31	5.69
7/8	12	009-50663	0.31	5.69
15/16	12	009-50664	0.44	6.29
1	12	009-50665	0.50	6.29

### Craftsman® 3/8-Inch Dual-Mark Sockets

#### Deep-depth (3/8-in. Metric Sockets)

Size mm	Points	Catalog No.	Wt. lb.	Price
9	6	009-45865	0.13	\$4.99
10	6	009-45866	0.19	4.99
11	6	009-45867	0.19	4.99
12	6	009-45868	0.19	4.99
13	6	009-45869	0.19	4.99
14	6	009-45871	0.19	4.99
15	6	009-45872	0.19	5.69
16	6	009-45873	0.25	5.69
17	6	009-45874	0.25	6.89
18	6	009-45875	0.25	6.89
19	6	009-45876	0.25	6.89
9	12	009-50666	0.13	4.99
10	12	009-50667	0.13	4.99
11	12	009-50668	0.13	4.99
12	12	009-50669	0.13	4.99
13	12	009-50670	0.13	4.99
14	12	009-50671	0.13	4.99
15	12	009-50672	0.13	5.69
16	12	009-50673	0.13	5.69
17	12	009-50674	0.13	6.89
18	12	009-50675	0.13	6.89
19	12	009-50676	0.19	6.89
21	12	009-50677	0.31	7.49
22	12	009-50678	0.38	7.49



mechanic's tools



**CRAFTSMAN®**

**spark plug, flexible,  
hex & torx®**

Choose from this complete collection of Craftsman bit drive, flex drive and spark plug sockets for use with ratchets and attachments for an ever-growing collection of unique and flexible fastener applications.

**Craftsman® 3/8-inch Drive Dual-Mark Spark Plug Sockets**

Size	Catalog No.	Wt. lbs.	Price
5/8 in.	009-34671	0.19	\$5.99
13/16 in.	009-50726	0.31	5.99
3/4 in.	009-50727	0.24	5.99
18 mm	009-50728	0.26	5.99

**3/8-Inch Drive Flexible Spark Plug Sockets.**

5/8 in.	009-43322	0.19	\$9.99
13/16 in.	009-43323	0.31	9.99

**1/2-Inch Drive Dual-Mark Spark Plug Sockets.**

5/8 in.	009-34037	0.19	\$6.99
13/16 in.	009-34038	0.31	6.99

**Craftsman® 1/4-inch Drive Flexible Sockets**

6 pt. Inch. Wt. 0.06 lb. each.

Size In./mm	Catalog No.	Price
3/16	009-43240	\$7.49
1/4	009-43241	7.49
5/16	009-43242	7.49
11/32	009-43243	7.49
3/8	009-43244	7.49
7/16	009-43245	7.49
1/2	009-43246	7.49
9/16	009-43247	7.49

6 pt. Metric. Wt. 0.06 lb. each.

5	009-43191	\$7.49
6	009-43192	7.49
7	009-43193	7.49
8	009-43194	7.49
9	009-43195	7.49
10	009-43196	7.49
11	009-43197	7.49
12	009-43198	7.49
13	009-43199	7.49
14	009-43200	7.49

**Craftsman® 3/8-inch Drive Flexible Sockets**

Inch. Wt. 0.13 lb. each.

Size, In./mm	Points	Catalog No.	Price
3/8	6	009-43261	\$8.49
7/16	6	009-43262	8.49
1/2	6	009-43263	8.49
9/16	6	009-43264	8.49
5/8	6	009-43265	8.49
11/16	6	009-43266	8.49
3/4	6	009-43267	8.49
3/8	12	009-43252	8.49
7/16	12	009-43253	8.49
1/2	12	009-43254	8.49
9/16	12	009-43255	8.49
5/8	12	009-43256	8.49
11/16	12	009-43257	8.49
3/4	12	009-43258	8.49

Metric. Wt. 0.13 lb. each.

10	6	009-43201	\$8.49
11	6	009-43202	8.49
12	6	009-43203	8.49
13	6	009-43204	8.49
14	6	009-43205	8.49
15	6	009-43206	8.49
16	6	009-43207	8.49
17	6	009-43208	8.49
18	6	009-43209	8.49
19	6	009-43211	8.49





Share

# OPEN STOCK

# sockets

mechanic's tools



### Craftsman® 1/2-inch Drive Hex and Torx® Bit Sockets

1/2-Inch Hex Bit Inch			
Size, In./mm	Catalog No.	Wt. lbs.	Price
9/16	009-46671	0.24	\$13.99
5/8	009-46672	0.24	13.99
1/2-Inch Hex Bit Metric			
14	009-42669	0.24	\$14.99
17	009-42670	0.24	13.99
1/2-Inch Torx® Bit Sockets			
T-55	009-34490	0.24	\$12.99
T-60	009-34491	0.24	12.99

### Craftsman® 1/4-inch Drive Bits

Torx® Bit Sockets. 1 5/8 Inches long.			
Size	Catalog No.	Wt. lbs.	Price
T15	009-42661	0.04	\$6.49
T20	009-42662	0.04	6.49
T25	009-42663	0.04	6.49
Slotted Bit Sockets. 1 7/8 Inches long.			
5-6	009-42691	0.06	\$3.99
6-8	009-42692	0.06	3.99
Phillips Bit Sockets. 1 5/8 Inches long.			
#1	009-42681	0.06	\$4.29
#2	009-42682	0.06	4.29
Hex Bit Sockets. 1 7/8 Inches long.			
3/16 in.	009-42701	0.10	\$5.49
7/32 in.	009-42702	0.10	5.49
1/4 in.	009-42703	0.15	5.49
5/16 in.	009-42704	0.15	5.49
3/8 in.	009-42705	0.15	5.49

### Craftsman® 3/8-inch Drive Bits

Hex Bit Sockets. Inch. 1 15/16 Inches long.			
Size In./mm	Catalog No.	Wt. lbs.	Price
5/32	009-46669	0.06	\$5.49
3/16	009-46661	0.06	5.49
7/32	009-46662	0.06	5.49
1/4	009-46663	0.13	5.49
5/16	009-46664	0.13	5.49
3/8	009-46665	0.13	5.49
Metric. 1 15/16 Inches long.			
4	009-42674	0.06	\$5.49
5	009-42675	0.06	5.49
6	009-42676	0.06	5.49
7	009-42067	0.13	5.49
8	009-42678	0.13	5.49
10	009-42679	0.13	5.49
Phillips Bit Sockets. 2 3/4 Inches long.			
#1	009-44369	0.13	\$5.49
#2	009-44371	0.13	5.49
#3	009-44372	0.13	5.49
#4	009-44373	0.13	5.49
Slotted Bit Sockets. 1 15/16 Inches long.			
5-6	009-42651	0.13	\$5.49
8-10	009-42652	0.13	5.49
14-16	009-42653	0.13	5.49
Torx® Bit Sockets. 1 5/8 Inches long.			
T27	009-34488	0.13	\$6.49
T30	009-42664	0.13	6.49
T40	009-42665	0.13	6.49
T45	009-42666	0.13	6.49
T47	009-34489	0.13	9.49
T50	009-42667	0.13	6.49





# flex handles, drive tools extensions, socket adapters & quick release ratchets

Add the flexibility you need to handle any project from this collection of Craftsman drive tools. Select the right ratchets, nut drivers, socket adapters, extensions and other unique drive tools to round out your collection.



### Craftsman® Flex T-Handles

Drive In.	Length In.	Stops At	Catalog No.	Wt. lbs.	Price
1/4	6	0°	009-43523	0.25	\$8.99
3/8	10	0°, 45°	009-44363	0.69	11.99
1/2	15	0°, 45°	009-44201	1.75	24.99
1/2	18	0°, 45°	009-44202	1.75	27.99
3/4	18	none	009-04431	2.81	52.99

### Craftsman® Slide Bar Handles

Loosen nuts and bolts.

Drive In.	Length In.	Catalog No.	Wt. lbs.	Price
1/4	4 1/2	009-04354	0.25	\$8.99
3/8	7	009-04428	0.38	11.99
1/2	9	009-44152	0.75	13.99
1/2	15	009-44151	1.38	12.99
3/4	18	009-04443	3.00	31.99

### Craftsman Flex Spinner

1/4	6	009-04355	0.31	\$9.99
-----	---	-----------	------	--------

### Craftsman Square-Drive Spinner Handles

1/4	6	009-43393	0.25	\$9.99
1/4	4	009-43351	0.19	5.49

### Craftsman® Socket Adapters

Convert your ratchet from one size drive size to another in seconds.

Drive In.	Length In.	Catalog No.	Wt. lbs.	Price
1/4	3/8	009-04257	0.06	\$3.99
3/8	1/4	009-04256	0.13	3.99
3/8	1/2	009-04258	0.13	3.99
1/2	3/8	009-04259	0.13	5.99
1/2	3/4	009-04271	0.31	6.99

### Craftsman® Nickel Chrome-Plated Quick-Release Ratchets

**Next Generation Full Polish Thin Profile Ratchet** Fine tooth action allows for efficiency in cramped areas with 6 degrees of swing. With reverse lever and comfort grip.

Drive In.	Length In.	Catalog No.	Wt. lbs.	Price
1/4	5 3/8	009-44994	0.44	\$24.99
3/8	7 11/16	009-44995	0.75	32.99
1/2	10 3/8	009-44996	1.44	39.99

**Quick-Release Full Polish Teardrop Ratchet** Rust resistant with ergonomic handle that provides greater comfort over extended periods of use.

1/4	5 1/2	009-44812	0.31	\$22.99
3/8	7 11/16	009-44813	0.69	27.99
1/2	10 3/8	009-44814	1.44	38.99

### Quick-Release Extra Long Teardrop Ratchet

3/8	11	009-44833	0.84	\$32.99
-----	----	-----------	------	---------

### Quick-Release Stubby Flex Teardrop Ratchet

3/8	5 1/2	009-44834	0.5	\$24.99
-----	-------	-----------	-----	---------

### Quick-Release 22° Offset Flex Teardrop Ratchet

3/8	11 1/8	009-44835	1.34	\$32.99
-----	--------	-----------	------	---------

### Quick-Release Ergo Flex Teardrop Ratchet

3/8	12	009-44836	1.34	\$32.99
-----	----	-----------	------	---------

### Quick-Release Teardrop Ratchet

One-hand reversing lever.				
1/4	5 1/4	009-44807	0.25	\$12.99
3/8	6 7/8	009-44811	0.50	15.99
3/8	7 11/16	009-44808	0.60	17.99
1/2	10 3/8	009-44809	1.44	22.99
3/4	19 13/16	009-44804	5.00	89.99

**Quick-Release Teardrop Flex-Head Ratchet** 36 teeth equate to 10 degree arc ratcheting. Head pivots 0 to 90 degrees.

3/8	11 9/16	009-44815	1.28	\$20.99
1/2	16 13/16	009-44816	2.19	32.99

### Nickel Chrome-Plated Round Head Ratchets

1/4	5	009-43174	0.24	\$11.99
3/8	6 1/2	009-43175	0.47	14.99
1/2	9 3/4	009-43176	1.19	20.99

**Premium Grade Ratchets** Long ergonomic handles increase torque and comfort. 84-tooth gear allows 4.5° arc swing.

1/4	6 1/4	009-25479	0.37	\$49.99
3/8	9	009-02548	0.89	59.99
1/2	11 1/2	009-25482	1.75	79.99



# OPEN STOCK

## Craftsman® Extension Bars

Drive In.	Length In.	Catalog No.	Wt. lbs.	Price
1/4	1 1/2	009-43538	0.13	\$2.99
1/4	3	009-43539	0.19	3.99
1/4	4 flex	009-04336	0.19	7.99
1/4	6	009-43531	0.25	4.99
1/4	14	009-43532	0.31	9.99
3/8	1 1/2	009-43537	0.13	3.99
3/8	3	009-44264	0.13	4.99
3/8	6	009-44261	0.38	6.99
3/8	10	009-44262	0.56	9.49
3/8	20	009-44263	0.81	13.99
1/2	2	009-43522	0.19	4.99
1/2	3	009-44133	0.25	5.99
1/2	6	009-44131	0.63	7.99
1/2	10	009-44132	0.90	9.99
1/2	20	009-44134	1.31	15.99
3/4	5	009-04440	0.94	24.99
3/4	8	009-04441	1.69	27.99
3/4	16	009-04442	2.56	31.99

## Craftsman® Drive Tools and Accessories

### Craftsman Square-Drive Universal Joint

Drive In.	Catalog No.	Wt. lbs.	Price
1/4	009-04280	0.06	\$8.99
3/8	009-04435	0.10	9.99
1/2	009-04425	0.31	11.99

### Craftsman Inch Square-Drive Speeder Wrench

1/4 sq. drive.	009-04281	0.63	\$16.99
3/8 sq. drive.	009-44271	1.13	19.99
1/2 sq. drive.	009-44161	1.81	22.99

### Craftsman Inch Stud Remover for Headless Bolts

1/2 sq. drive.	009-04458	0.88	\$24.99
----------------	-----------	------	---------

### Craftsman Inch 3-piece Ratchet Speeder Disc Set

1/4, 3/8, 1/2	009-44191	0.25	\$5.29
---------------	-----------	------	--------

## Craftsman® Nut Drivers and Extensions

### Inch Nut Drivers

Thread Size	Nut Size, In./mm	Catalog No.	Wt. lbs.	Price
2, 3	3/16	009-41977	0.25	\$6.49
4	1/4	009-41971	0.25	6.49
5, 6	5/16	009-41972	0.25	6.99
8	11/32	009-41973	0.25	6.99
10	3/8	009-41974	0.25	7.79
12, 1/4	7/16	009-41975	0.31	7.79
5/16	1/2	009-41976	0.31	8.29

### Metric Nut Drivers

M2.5	5	009-41981	0.19	\$6.49
M3.5	6	009-41982	0.19	6.49
M4	7	009-41983	0.19	6.79
M5	8	009-41984	0.19	6.79
M5.5	9	009-41985	0.19	7.49
M6	10	009-41986	0.25	7.49
M7	11	009-41987	0.25	7.79

### Wobble Extensions, Inch

1 1/2	3/8	009-44282	0.091	\$6.99
3	3/8	009-44283	0.174	7.99
6	3/8	009-44286	0.321	9.99
10	3/8	009-44287	0.490	11.99
1 1/2	1/4	009-43177	0.052	5.99
3	1/4	009-44288	0.071	6.99
6	1/4	009-44289	0.139	8.99
2	1/2	009-43178	0.220	8.99
3	1/2	009-44292	0.274	9.99
6	1/2	009-44293	0.571	10.99

### Thumbwheel Ratchets, Inch

1 1/2 dia.	1/4	009-43397	0.25	\$19.99
1 1/2 dia.	3/8	009-43398	0.25	19.99

# specialty hand tools





**Craftsman Pinless Swivel Impact Sockets** provide enhanced strength, long spring life and up to 360-degree flex access, while high performance 3/4 and 1-inch drive impact sockets combine the strength and durability you need for heavy-duty applications. Add to your set from the complete collection of open stock listed here.

### Craftsman® Pinless Swivel Impact Sockets Online Exclusives

3/8-in. Drive Inch.			
Size, in./mm	Catalog No.	Wt. lbs.	Price
3/8	009-15780	0.235	\$29.99
7/16	009-15781	0.244	29.99
1/2	009-15782	0.258	29.99
9/16	009-15783	0.272	29.99
5/8	009-15784	0.277	29.99
11/16	009-15785	0.292	29.99
3/4	009-15786	0.291	29.99

3/8-in. Drive Metric.			
10	009-15790	0.242	\$29.99
11	009-15791	0.244	29.99
12	009-15792	0.247	29.99
13	009-15793	0.243	29.99
14	009-15794	0.274	29.99
15	009-15795	0.282	29.99
16	009-15796	0.276	29.99
17	009-15797	0.285	29.99
18	009-15798	0.289	29.99

1/2-in. Drive Inch.			
1/2	009-15800	0.270	\$36.99
9/16	009-15801	0.284	36.99
5/8	009-15802	0.289	36.99
11/16	009-15803	0.543	41.99
3/4	009-15804	0.603	41.99
13/16	009-15805	0.634	41.99
7/8	009-15806	0.648	41.99
15/16	009-15807	0.664	41.99
1	009-15808	0.700	46.99

1/2-in. Drive Metric.			
13	009-15810	0.255	\$36.99
14	009-15811	0.286	36.99
15	009-15812	0.294	36.99
16	009-15813	0.520	41.99
17	009-15814	0.546	41.99
18	009-15815	0.567	41.99
19	009-15816	0.604	41.99
21	009-15817	0.665	41.99
22	009-15818	0.676	46.99

Universal Joint.			
3/8	009-23766	0.210	\$34.99
1/2	009-23765	0.445	44.99

### Craftsman® Dual-Mark Impact Sockets

3/8-in. Drive Inch.			
Size, in./mm	Catalog No.	Wt. lbs.	Price
1/4	009-15830	0.06	\$5.69
5/16	009-15831	0.06	5.69
3/8	009-15832	0.13	5.69
7/16	009-15833	0.13	5.69
1/2	009-15834	0.13	5.69
9/16	009-15835	0.19	5.69
5/8	009-15836	0.19	5.69
11/16	009-15837	0.19	5.69
3/4	009-15838	0.25	5.69

3/8-in. Drive Inch Deep.			
1/4	009-15890	0.19	\$7.19
5/16	009-15891	0.19	7.19
3/8	009-15892	0.19	7.19
7/16	009-15893	0.19	7.19
1/2	009-15894	0.19	7.19
9/16	009-15895	0.25	7.19
5/8	009-15896	0.25	7.19
11/16	009-15897	0.31	7.19
3/4	009-15898	0.31	7.19

3/8-in. Drive Metric.			
10	009-15839	0.13	\$5.69
11	009-15840	0.13	5.69
12	009-15841	0.13	5.69
13	009-15842	0.19	5.69
14	009-15843	0.19	5.69
15	009-15844	0.19	5.69
16	009-15976	0.19	5.69
17	009-15845	0.19	5.69
18	009-15846	0.19	5.69
19	009-15847	0.25	5.69

3/8-in. Drive Metric Deep.			
10	009-15899	0.19	\$7.19
11	009-15900	0.19	7.19
12	009-15901	0.19	7.19
13	009-15902	0.19	7.19
14	009-15903	0.25	7.19
15	009-15904	0.25	7.19
16	009-15905	0.25	7.19
17	009-15906	0.31	7.19
18	009-15907	0.31	7.19
19	009-15908	0.31	7.19

### Craftsman® Dual-Mark Impact Sockets

1/2-inch Drive Inch Impact Sockets.			
Size, in./mm	Catalog No.	Wt. lbs.	Price
3/8	009-15848	0.19	\$7.19
7/16	009-15849	0.19	7.19
1/2	009-15850	0.19	7.19
9/16	009-15851	0.19	7.19
5/8	009-15852	0.19	7.19
11/16	009-15853	0.25	7.19
3/4	009-15854	0.31	8.49
13/16	009-15855	0.38	8.49
7/8	009-15856	0.38	8.49
15/16	009-15857	0.44	9.49
1	009-15858	0.50	9.49
1 1/16	009-15859	0.50	9.99

1/2-in. Drive Inch Deep.			
3/8	009-15995	0.44	\$9.49
7/16	009-15996	0.44	9.49
1/2	009-15997	0.44	9.49
9/16	009-15998	0.44	9.49
5/8	009-15999	0.44	9.49
11/16	009-16060	0.44	10.99
3/4	009-16061	0.50	10.99
13/16	009-16062	0.63	11.99
7/8	009-16063	0.75	11.99
15/16	009-15983	0.75	11.99
1	009-15984	0.81	11.99
1 1/16	009-15985	0.88	12.99

1/2-in. Drive Metric.			
12	009-15860	0.19	\$7.19
13	009-15861	0.19	7.19
14	009-15862	0.19	7.19
15	009-15863	0.19	7.19
16	009-15864	0.25	7.19
17	009-15865	0.25	7.19
18	009-15866	0.25	8.49
19	009-15867	0.31	8.49
21	009-15868	0.31	8.49
22	009-15869	0.31	9.49
24	009-15870	0.44	9.49
27	009-15871	0.50	9.99

1/2-in. Drive Metric Deep.			
12	009-16073	0.44	\$7.99
13	009-16074	0.44	7.99
14	009-16075	0.44	7.99
15	009-16076	0.44	7.99
16	009-16077	0.44	10.99
17	009-16078	0.44	10.99
18	009-16079	0.44	11.99
19	009-16080	0.50	11.99
21	009-16081	0.63	11.99
22	009-16085	0.75	12.49
24	009-16086	0.75	12.49
27	009-16087	0.88	12.99



# CRAFTSMAN®

Share

# OPEN STOCK

# 3/8, 1/2, 3/4 & 1 inch impact sockets

# impact sockets

### Craftsman® Dual-Mark Impact Sockets

#### 3/4-in. Drive Inch.

Size, in./mm	Catalog No.	Wt. lbs.	Price
3/4	009-15909	0.63	\$23.99
13/16	009-15910	0.71	23.99
7/8	009-15911	0.74	24.99
15/16	009-15912	0.75	24.99
1	009-15913	0.74	25.99
1 1/16	009-15914	0.76	27.99
1 1/8	009-15915	0.87	29.99
1 3/16	009-15916	0.94	32.99
1 1/4	009-15917	1.10	32.99
1 5/16	009-15918	1.24	34.99
1 3/8	009-15919	1.33	37.99
1 7/16	009-15920	1.44	39.99
1 1/2	009-15921	1.59	41.99
1 5/8	009-15922	1.73	46.99
1 11/16	009-15923	1.79	49.99
1 3/4	009-15924	1.70	54.99
1 13/16	009-15925	1.70	59.99
1 7/8	009-15926	1.80	64.99
1 15/16	009-15927	2.20	69.99
2	009-15928	2.40	79.99

#### 3/4-in. Drive Inch Deep.

Size, in./mm	Catalog No.	Wt. lbs.	Price
15/16	009-15941	1.37	\$37.99
1	009-15942	1.30	39.99
1 1/16	009-15943	1.49	42.99
1 1/8	009-15944	1.44	43.99
1 3/16	009-15945	1.60	44.99
1 1/4	009-15946	1.90	47.99
1 5/16	009-15947	1.94	49.99
1 3/8	009-15948	2.03	54.99
1 7/16	009-15949	2.21	59.99
1 1/2	009-15950	2.30	62.99
1 5/8	009-15951	2.44	69.99

### Craftsman® Dual-Mark Impact Sockets

#### 3/4-in. Drive Hex Bits.

Size, in./mm	Catalog No.	Wt. lbs.	Price
9/16	009-15958	1.33	\$37.99
5/8	009-15959	1.41	39.99
3/4	009-15960	1.61	44.99
7/8	009-15961	1.78	47.99
1	009-15962	2.27	49.99

#### 3/4-in. Drive Metric Hex Bits.

Size, in./mm	Catalog No.	Wt. lbs.	Price
14	009-15963	1.33	\$37.99
17	009-15964	1.41	39.99
19	009-15965	1.65	44.99
22	009-15966	1.76	47.99
24	009-15967	2.25	49.99

#### 1-in. Drive Inch.

Size, in./mm	Catalog No.	Wt. lbs.	Price
1	009-15161	1.55	\$44.99
1 1/16	009-15162	1.55	44.99
1 1/8	009-15055	1.65	47.99
1 1/4	009-15056	1.60	47.99
1 5/16	009-15057	1.72	49.99
1 3/8	009-15058	1.84	49.99
1 7/16	009-15059	1.90	52.99
1 1/2	009-15060	1.95	54.99
1 5/8	009-15061	1.85	57.99
1 11/16	009-15062	2.00	64.99
1 3/4	009-15063	2.33	67.99
1 13/16	009-15064	2.40	69.99
1 7/8	009-15065	2.35	72.99
2	009-15066	2.95	79.99
2 1/16	009-15067	2.50	84.99
2 3/16	009-15068	3.70	89.99
2 1/4	009-15069	3.55	94.99
2 3/8	009-15070	4.36	99.99
2 9/16	009-15071	4.55	119.99
2 5/8	009-15072	4.70	129.99
2 3/4	009-15073	6.20	134.99
3	009-15074	8.10	149.99

### Craftsman® Dual-Mark Impact Sockets

#### 3/4-in. Drive Metric.

Size, in./mm	Catalog No.	Wt. lbs.	Price
19	009-15929	0.62	\$23.99
20	009-15930	0.66	23.99
21	009-15931	0.68	24.99
22	009-15932	0.72	24.99
23	009-15933	0.74	25.99
24	009-15934	0.78	27.99
27	009-15935	0.76	29.99
30	009-15936	0.91	32.99
32	009-15937	1.00	34.99
36	009-15938	1.39	39.99
41	009-15939	1.71	44.99
46	009-15940	2.16	59.99

#### 3/4-in. Drive Metric Deep.

Size, in./mm	Catalog No.	Wt. lbs.	Price
24	009-15952	1.37	\$37.99
26	009-15953	1.40	39.99
27	009-15954	1.49	42.99
30	009-15955	1.81	44.99
32	009-15956	2.07	49.99
36	009-15957	2.53	59.99

### Craftsman® Impact Accessories

**1/2-In. Drive Double-End Socket** 6 pt. openings: 3/4-in. at one end, 13/16-in. at the other. For 1/2-in. drive impact tools with extended shank.

Drive in.	Catalog No.	Wt. lbs.	Price
1/2	009-19495	0.44	\$9.99

#### Universal Joint

Size, in.	Catalog No.	Wt. lbs.	Price
1/2	009-19492	0.44	\$16.99
3/8	009-19491	0.31	14.99

**Socket Adapter** Converts 1/2-in. drive to 3/8-in. drive.

Size, in.	Catalog No.	Wt. lbs.	Price
1/2	009-19494	0.25	\$10.49

#### Extension Bars

Drive in.	Length in.	Catalog No.	Wt. lbs.	Price
1/2	10	009-19499	1.00	\$13.99
1/2	6	009-19493	0.63	11.99
1/2	3	009-19498	0.31	9.99
3/8	6	009-19497	0.50	9.99
3/8	3	009-19496	0.25	8.49





**CRAFTSMAN®**

# choose the right compressor



### Air Compressor Recommendation Chart

Which compressor is right for you? (Information based on required airflow.)

Tool	1-Gal.	2-Gal.	3-Gal.	4-Gal. Twin Stack	5-Gal.	6-Gal. Pancake	7-Gal.	12-Gal.	17-Gal.	26-Gal.	33-Gal.	25-Gal. Pro	25-Gal. Pro	60-Gal. Pro	60-Gal. Pro	80-Gal.
3/8 in. Impact Wrench								●	●	●	●	●	●	●	●	●
1/2 in. Impact Wrench								●	●	●	●	●	●	●	●	●
3/4 in. Impact Wrench								●	●	●	●	●	●	●	●	●
1/4 in. Air Ratchet							●	●	●	●	●	●	●	●	●	●
3/8 in. Air Ratchet								●	●	●	●	●	●	●	●	●
Right Angle Grinder								●	●	●	●	●	●	●	●	●
Cut-Off Tool									●	●	●	●	●	●	●	●
Dual Action Sander									●	●	●	●	●	●	●	●
Orbital Sander								●	●	●	●	●	●	●	●	●
High-Speed Sander								●	●	●	●	●	●	●	●	●
3/8 in. Air Drill									●	●	●	●	●	●	●	●
Air Hammer							●	●	●	●	●	●	●	●	●	●
Spray Gun							●	●	●	●	●	●	●	●	●	●
HVLP Gravity Spray Gun							●	●	●	●	●	●	●	●	●	●
HVLP Suction Spray Gun							●	●	●	●	●	●	●	●	●	●
Detail Spray Gun				●	●	●	●	●	●	●	●	●	●	●	●	●
Grease Gun	●	●	●	●	●	●	●	●	●	●	●	●	●	●	●	●
18-Gauge Brad Nailer	●	●	●	●	●	●	●	●	●	●	●	●	●	●	●	●
1/4 in. Crown Stapler	●	●	●	●	●	●	●	●	●	●	●	●	●	●	●	●
16-Gauge Finish Nailer	●	●	●	●	●	●	●	●	●	●	●	●	●	●	●	●
Roofing Nailer			●	●	●	●	●	●	●	●	●	●	●	●	●	●
Framing Nailer		●	●	●	●	●	●	●	●	●	●	●	●	●	●	●
Auto Tire Inflation	●	●	●	●	●	●	●	●	●	●	●	●	●	●	●	●

● = **Light Use:** the compressor will run the tool, only long enough to complete a very short task.

● = **Typical Use:** the tool will perform normal tasks and tool will perform as expected.

● = **Heavy Use:** the tool can be used for extended periods of time without exhausting the compressor's air supply.



# punches, pry bars & chisels

# OPEN STOCK

For easy clean-up, high visibility and durable corrosion protection, these long-lasting Craftsman punches and chisels feature the unique "Bright Red E-Coat".

general purpose

## Craftsman® Punches, Line-Up Tools, Chisels & Pry Bars

**Pin Punches.** For driving pins, bolts, etc. out of holes. Meets ANSI standard B107.48M.

Point In.	Lgth. In.	Catalog No.	Wt. lb.	Price
1/16	4	009-42881	0.06	\$4.99
3/32	4	009-42882	0.06	4.99
1/8	4 1/2	009-42883	0.11	4.99
5/32	5	009-42884	0.11	4.99
3/16	5	009-42885	0.13	4.99
1/4	5 1/2	009-42886	0.15	4.99

### Roll Pin Punch.

1/8 x 4 1/2	009-42212	0.41	\$4.99
5/32 x 5	009-42213	0.41	4.99
3/16 x 5	009-42214	0.41	4.99
7/32 x 5	009-42215	0.62	4.99
1/4 x 5 1/2	009-42217	0.62	5.49
5/16 x 5 1/2	009-42218	0.62	5.49

### Center Pin Punch.

5/32 x 7 1/2	009-42219	0.41	\$5.99
3/16 x 7 1/2	009-42220	0.62	5.99
7/32 x 7 1/2	009-42221	0.62	5.99
1/4 x 7 1/2	009-42222	0.62	5.99
5/16 x 7 1/2	009-42223	0.62	6.49
3/8 x 7 1/2	009-42224	0.72	6.49

**Craftsman Center Punches.** Marks points for starting drill holes.

3/8	4 1/2	009-42861	0.13	\$4.99
1/2	6	009-42862	0.13	5.99

**Craftsman Prick Punch.** Pierces thin sheet metal; marks layout lines.

3/8	4 1/2	009-42841	0.13	\$4.99
-----	-------	-----------	------	--------

**Line-Up Tools.** Line up holes in pieces of metal for bolts, shafts, etc. Not for impact use.

Size in.		Catalog No.	Wt. lb.	Price
5/32 x 7	-	009-42901	0.19	\$5.99
3/16 x 9	-	009-42902	0.40	7.99
1/4 x 12	-	009-42903	0.78	8.99

### Craftsman 16-inch Pry Bar.

Chrome vanadium steel. Black oxide finish.

1/2 inch Dia.	-	009-4283	0.88	\$11.49
---------------	---	----------	------	---------

**Cold Chisels.** Standard length. Meets ANSI standard B107.47M.

Point In.	Lgth. In.	Catalog No.	Wt. lb.	Price
1/4	4	009-42971	0.06	\$4.49
3/8	5	009-42972	0.13	5.49
1/2	5 3/4	009-42973	0.27	6.99
5/8	6	009-42974	0.33	7.49
3/4	6 1/2	009-42975	0.59	8.49
7/8	7 1/2	009-42976	0.91	9.99

### Extra-Long 12-inch Chisels.

1/2	12	009-42851	0.38	\$7.99
5/8	12	009-42852	0.68	8.49
3/4	12	009-42853	0.88	8.99
7/8	12	009-42854	1.31	9.99

# CRAFTSMAN®



# screwdrivers & pliers

## Craftsman® Professional Screwdrivers

### Torx® (Pro Screwdriver)

Size	Catalog No.	Wt. lbs.	Price
T10 x 2 1/2	009-47176	0.13	\$6.99
T10 x 6	009-47180	0.22	6.99
T15 x 2 1/2	009-47178	0.163	6.99
T15 x 6	009-47181	0.22	6.99
T20 x 6	009-47182	0.22	6.99
T25 x 6	009-47212	0.22	6.99
T27 x 6	009-47213	0.22	6.99
T30 x 6	009-47214	0.22	6.99
T40 x 8	009-47171	0.44	9.99

### Phillips (Pro Screwdriver)

#0 x 3	009-47183	0.06	\$6.99
#1 x 4	009-47184	0.19	6.99
#2 x 4	009-47186†	0.27	8.99
#2 x 8	009-47215†	0.27	10.99
#2 x 12	009-47172	0.31	12.99
#2 x 16	009-47173	0.38	14.99
#2 x 20	009-47174	0.5	16.99

### Slotted (Pro Screwdriver)

Cab. tip 1/8 x 6	009-47163	0.13	\$7.99
Cab. tip 1/8 x 10	009-47164	0.13	9.99
1/8 x 3	009-47189	0.06	5.99
3/16 x 4	009-47204	0.19	6.99
3/16 x 6	009-47191	0.22	7.99
Cab. tip 3/16 x 6	009-47192	0.22	7.99
1/4 x 4	009-47194†	0.27	8.99
1/4 x 6	009-47195†	0.31	9.99
1/4 x 8	009-47196†	0.38	10.99
1/4 x 16	009-47161	0.38	14.99
1/4 x 20	009-47162	0.38	16.99
3/8 x 12	009-47166†	0.63	13.99

†Feature bolstered blades for added strength.

# CRAFTSMAN®

## PROFESSIONAL

The Craftsman Professional and Craftsman collections offer screwdrivers with precision-machined steel blades, nickel-chrome plated to resist corrosion. All Craftsman pliers feature tough heat-treated alloy steel for maximum durability.

## Craftsman® Adjustable Wrenches

### Satin Nickel Finish

Size in./Capacity in.	Catalog No.	Wt. lbs.	Price
4-in. / 1/2-in.	009-44601	0.125	\$12.99
6-in. / 3/4-in.	009-44602	0.25	14.99
8-in. / 7/8-in.	009-44603	0.625	16.99
10-in. / 1 1/8-in.	009-44604	0.875	18.99
12-in. / 1 5/16-in.	009-44605	1.625	27.99
15-in. / 1 11/16-in.	009-44662	2	42.99
18-in. / 2 1/16-in.	009-44606	4.125	69.99
24-in. / 2 7/16-in.	009-44608	6.5	99.99

### Black Nickel Finish

Size in./Capacity in.	Catalog No.	Wt. lbs.	Price
4-in. / 1/2-in.	009-04450	0.125	\$11.49
6-in. / 3/4-in.	009-04451	0.25	11.99
8-in. / 7/8-in.	009-04459	0.625	13.99
10-in. / 1 1/8-in.	009-04453	0.875	16.99
12-in. / 1 5/16-in.	009-04454	1.625	24.99
15-in. / 1 11/16-in.	009-04455	2	34.99
18-in. / 2 1/16-in.	009-04456	4.125	59.99
24-in. / 2 7/16-in.	009-04457	6.5	99.99





# OPEN STOCK

## CRAFTSMAN®

general purpose

### Craftsman® Slotted, Phillips, Torx® Screwdrivers

#### Slotted

Size In.	For Screws	Catalog No.	Wt. lbs.	Price
1/8 x 2	X-Small	009-41421	0.06	\$4.29
1/8 x 4	X-Small	009-41589	0.06	3.99
3/16 x 1 1/2	Small	009-41854	0.10	4.49
3/16 x 4	Small	009-41581	0.16	3.99
3/16 x 4	Cabinet**	009-41247	0.16	4.49
3/16 x 6	Small	009-41577	0.19	4.49
3/16 x 8	Cabinet**	009-41248	0.19	5.49
3/16 x 9	Small	009-41582	0.20	4.99
1/4 x 1 1/2	Medium	009-04151	0.11	4.49
1/4 x 4	Medium	009-41583	0.29	4.99
1/4 x 6	Medium	009-41584	0.28	4.99
1/4 x 8	Medium	009-41578	0.31	6.49
5/16 x 1 3/4	Large	009-41586	0.26	6.49
5/16 x 6	Large	009-41579	0.38	6.49
5/16 x 8	Large	009-41587	0.44	6.99
3/8 x 8	X-Large	009-41852	0.56	8.99
3/8 x 12	X-Large	009-41588	0.72	9.99

#### Phillips

0 x 2 1/2	X-Small	009-41293	0.04	\$2.99
1 x 1 1/2	Small	009-41855	0.10	3.99
1 x 3	Small	009-41294	0.09	3.99
2 x 1 1/2	Medium	009-04118	0.11	3.99
2 x 4	Medium	009-41295	0.17	4.29
2 x 6	Medium	009-41853	0.20	4.99
2 x 8	Medium	009-41296	0.23	5.49
3 x 6	Large	009-41297	0.31	6.99
4 x 8	X-Large	009-41298	0.50	9.49

#### Torx®

T6 x 3	—	009-41480	0.06	\$2.99
T10 x 4	—	009-41473	0.09	3.99
T15 x 4	—	009-41474	0.09	3.99
T20 x 4	—	009-41475	0.09	3.99
T25 x 4	—	009-41476	0.09	3.99
T27 x 4	—	009-41479	0.17	4.49
T30 x 4	—	009-41477	0.17	4.49

#### Other

Scratch Awl	—	009-41028	0.17	\$4.99
Cotter Key Puller	—	009-04319	0.31	7.99
Robertson Jr 1	—	009-41141	0.31	5.49
Robertson Jr 2	—	009-41142	0.31	5.49
Tack Puller	—	009-41397	0.31	6.49

\*\*For woodworking and cabinetmaking and removing covers on computers and electronic equipment.

### Craftsman® Solid-Joint Pliers

#### Diagonal Cutting Pliers.

For dashboard or auto ignition system.

Length In.	Catalog No.		Wt. lbs.	Price
5	009-45077	—	0.32	\$14.99
6	009-45075	—	0.38	15.99
7	009-45076	—	0.50	16.99

#### Heavy-Duty Wide-Jaw Diagonal Cutting Pliers.

Provides excellent leverage for easily cutting steel wire.

7	009-45074		0.56	\$17.49
---	-----------	--	------	---------

**15-Degree Angle Bent Wide-Jaw Diagonal Cutting Pliers.** Provides ideal leverage for working with steel wire in tight areas.

Length In.	Catalog No.		Wt. lbs.	Price
7	009-45084	—	0.56	\$19.99

**Linesman Pliers.** Beveled nose with side-cutting jaws is ideal for working with phone wire.

7	009-45093	—	0.63	\$18.99
8	009-45094	—	1.00	20.99

#### Slip-Joint Pliers.

Length In.	Catalog No.	Positions/Capacity	Wt. lbs.	Price
6 3/4	009-45378	2-3/16-in.	0.44	\$8.99
8	009-45379	2-1-in.	0.58	11.99
10	009-45380	2-1 15/16-in.	0.94	13.99

**Long-Nose Pliers.** For delicate work like wire loops. Tapered jaws. Side cutter.

6	009-45102	—	0.38	\$15.99
8	009-45103	—	0.47	16.99

**Bent Long-Nose Pliers.** For tight areas.

6	009-45104	—	0.36	\$17.99
---	-----------	---	------	---------

**Duckbill Pliers.** For superior gripping.

8	009-45087	—	0.50	\$17.99
---	-----------	---	------	---------

**Long Reach Long-Nose Pliers.** For hard to-reach-areas.

8	009-45085	—	0.47	\$17.99
---	-----------	---	------	---------

#### Craftsman Arc-Joint Pliers.

Length In.	Catalog No.	Positions/Capacity	Wt. lbs.	Price
7	009-45385	3-7/8-in.	0.41	\$13.99
9 1/2	009-45381	5-1 1/2-in.	0.88	15.49
13	009-45386	7-2 1/2-in.	1.69	26.99
16 1/2	009-45384	11-4-in.	2.88	44.99

### Craftsman® Laminated Pliers

Description	Catalog No.	Wt. lbs.	Price
6 1/2-in. slip joint	009-45750	0.53	\$7.49
8-in. adjustable joint	009-45753	0.79	9.99
6 1/2-in. long nose	009-45755	0.50	9.99
6-in. diagonal cutter	009-45758	0.52	9.99
8-in. slip joint	009-45754	0.81	8.99
10-in. adjustable joint	009-45756	1.10	9.99



**CRAFTSMAN**<sup>®</sup>**P R O F E S S I O N A L**

# band saw blades

**Craftsman<sup>®</sup> Professional Band Saw Blades**

Description	Catalog No.	Application	Wt. oz.	Price
Hard Edge/Flex Back 114-in. x 3/16-in. x .025 x 10T Reg.	<b>009-29534</b>	Fits Sears 15-in. Wood/Metal Cutting Band Saw 22440: Mild scroll cuts in hard/soft wood from 3/8-in. to 3-in. thick	9	<b>\$19.99</b>
Hard Edge/Flex Back 114-in. x 1/4-in. x .025 x 6T Skip	<b>009-29535</b>	Fits Sears 15-in. Wood/Metal Cutting Band Saw 22440: General purpose cuts in hard/soft wood from 1/2-in. to 4-in. thick	10	<b>19.99</b>
Hard Edge/Flex Back 114-in. x 1/2-in. x .025 x 3T Hook	<b>009-29536</b>	Fits Sears 15-in. Wood/Metal Cutting Band Saw 22440: Re-saw cuts in hard/soft wood from 1-in. to 8-in. thick	12	<b>19.99</b>
Hard Edge/Flex Back 114-in. x 3/4-in. x .032 x 2T Hook	<b>009-29537</b>	Fits Sears 15-in. Wood/Metal Cutting Band Saw 22440: Heavy-duty re-saw cuts in hard/soft wood to 10-in. thick	20	<b>23.99</b>
Hard Edge/Hard Back 114-in. x 1/4-in. x .025 x 18T Reg.	<b>009-29538</b>	Fits Sears 15-in. Wood/Metal Cutting Band Saw 22440: Cuts non-ferrous metal and mild steel 3/16-in.+ thick	10	<b>19.99</b>
Hard Edge/Hard Back 114-in. x 1/2-in. x .025 x 14T Reg.	<b>009-29539</b>	Fits Sears 15-in. Wood/Metal Cutting Band Saw 22440: Cuts non-ferrous metal and mild steel 1/4-in.+ thick	12	<b>20.99</b>
Bi-Metal 114-in. x 1/4-in. x .025 x 10/14 Vari Pitch	<b>009-29540</b>	Fits Sears 15-in. Wood/Metal Cutting Band Saw 22440: Cuts hardened steel and exotic metal 5/16-in.+ thick	10	<b>55.99</b>
Bi-Metal 114-in. x 1/2-in. x .025 x 14/18 Vari Pitch	<b>009-29541</b>	Fits Sears 15-in. Wood/Metal Cutting Band Saw 22440: Cuts hardened steel and exotic metal 7/32-in.+ thick	12	<b>55.99</b>
Hard Edge/Hard Back 93-in. x 3/4-in. x .032 x 10T Reg.	<b>009-29542</b>	Fits Sears 7 x 12-in. Horizontal Wet-Dry Metal Cutting Band Saw 22612: Cuts non-ferrous metal and mild steel 5/16-in. + thick	17	<b>22.99</b>
Hard Edge/Hard Back 93-in. x 3/4-in. x .032 x 14T Reg.	<b>009-29543</b>	Fits Sears 7 x 12-in. Horizontal Wet-Dry Metal Cutting Band Saw 22612: Cuts non-ferrous metal and mild steel 3/16-in. + thick	17	<b>22.99</b>
Hard Edge/Hard Back 93-in. x 3/4-in. x .032 x 18T Reg.	<b>009-29544</b>	Fits Sears 7 x 12-in. Horizontal Wet-Dry Metal Cutting Band Saw 22612: Cuts non-ferrous metal and mild steel 5/32-in. + thick	17	<b>22.99</b>
Hard Edge/Hard Back 93-in. x 3/4-in. x .032 x 10T Wavy	<b>009-29561</b>	Fits Sears 7 x 12-in. Horizontal Wet-Dry Metal Cutting Band Saw 22612: Cuts non-ferrous metal and mild steel 5/16-in. + thick	17	<b>22.99</b>
Hard Edge/Hard Back 93-in. x 3/4-in. x .032 x 14T Wavy	<b>009-29562</b>	Fits Sears 7 x 12-in. Horizontal Wet-Dry Metal Cutting Band Saw 22612: Cuts non-ferrous metal and mild steel 3/16-in. + thick	17	<b>22.99</b>
Hard Edge/Hard Back 93-in. x 3/4-in. x .032 x 18T Wavy	<b>009-29563</b>	Fits Sears 7 x 12-in. Horizontal Wet-Dry Metal Cutting Band Saw 22612: Cuts non-ferrous metal and mild steel 5/32-in. + thick	17	<b>22.99</b>
Bi-Metal 93-in. x 3/4-in. x .035 x 8/12 Vari Pitch	<b>009-26623</b>	Fits Sears 7 x 12-in. Horizontal Wet-Dry Metal Cutting Band Saw 22612: Cuts hardened steel and exotic metal 3/8-in. + thick	17	<b>29.99</b>
Bi-Metal 93-in. x 3/4-in. x .035 x 10/14 Vari Pitch	<b>009-26624</b>	Fits Sears 7 x 12-in. Horizontal Wet-Dry Metal Cutting Band Saw 22612: Cuts hardened steel and exotic metal 5/16-in. + thick	17	<b>29.99</b>
Bi-Metal 64 1/2-in. x 1/2-in. x .025 x 10/14 Vari Pitch	<b>009-26625</b>	Fits New Sears 5 x 6 in. Horizontal Band Saw 009-21414 and most popular 4 x 6 in. Horizontal Band Saws. Metal Cutting Band Saws: Cuts hardened steel and exotic metals 5/16-in.+ thick	7	<b>24.99</b>

**Choose from this complete list of Craftsman Professional band saw blades. For your convenience, we've listed by description, type and number of the saw, by application and by Craftsman number to ensure you find just what you need.**





# OPEN STOCK

## Craftsman® Professional Band Saw Blades

Description	Catalog No.	Application	Wt. oz.	Price
Bi-Metal 64 1/2-in. x 1/2-in. x .025 x 14/18 Vari Pitch	<b>009-26626</b>	Fits New Sears 5 x 6 in. Horizontal Band Saw 009-21414 and most popular 4 x 6 in. Horizontal Band Saws. Metal Cutting Band Saws: Cuts hardened steel and exotic metals 3/16-in.+ thick	7	<b>\$24.99</b>
Hard Edge/Flex Back 111-in. x 3/4-in. x .032 x 6T Hook	<b>009-26634</b>	Fits Sears 15-in. Wood/Metal Cutting Band Saw: Heavy-duty cuts in hard/soft wood from 1/2-in. to 4-in. thick	20	<b>15.99</b>
Hard Edge/Flex Back 111-in. x 1/2-in. x .025 x 18T Hook	<b>009-26637</b>	Fits Sears 15-in. Wood/Metal Cutting Band Saw: Cuts non-ferrous metal and mild steel 3/16-in.+ thick	12	<b>15.99</b>
Hard Edge/Flex Back 111-in. x 1/2-in. x .025 x 14T Hook	<b>009-26660</b>	Fits Sears 15-in. Wood/Metal Cutting Band Saw: Cuts non-ferrous metal and mild steel 1/4-in.+ thick	12	<b>15.99</b>
Hard Edge/Flex Back 111-in. x 1/2-in. x .025 x 6T Hook	<b>009-26661</b>	Fits Sears 15-in. Wood/Metal Cutting Band Saw: Cuts hard/soft wood from 1/2-in. to 4-in. thick	12	<b>15.99</b>
Hard Edge/Flex Back 111-in. x 3/4-in. x .032 x 3T Hook	<b>009-26662</b>	Fits Sears 15-in. Wood/Metal Cutting Band Saw: Cuts hard/soft wood to 8-in. thick	20	<b>15.99</b>
Hard Edge/Flex Back 133-in. x 3/4-in. x .032 x 12T Hook	<b>009-26635</b>	Fits Sears 18-in. Wood/Metal Cutting Band Saw 009-22412: Cuts non-ferrous metal and mild steel 1/4-in.+ thick	20	<b>19.99</b>
Hard Edge/Flex Back 133-in. x 3/4-in. x .032 x 14T Hook	<b>009-26658</b>	Fits Sears 18-in. Wood/Metal Cutting Band Saw 009-22412: Cuts non-ferrous metal and mild steel 7/32-in.+ thick	20	<b>19.99</b>
Hard Edge/Flex Back 80-in. x 3/16-in. x .025 x 10T Reg.	<b>009-26683</b>	Fits older Sears 12-in. Band Saws: Mild scroll cuts in hard/soft wood from 3/8-in. to 3-in. thick	4	<b>12.99</b>
Hard Edge/Flex Back 80-in. x 1/2-in. x .025 x 3T Reg.	<b>009-26684</b>	Fits older Sears 12-in. Band Saws: Re-saw cuts in hard/soft wood up to 5-in. thick	8	<b>12.99</b>
Hard Edge/Flex Back 91-in. x 3/16-in. x .025 x 10T Reg.	<b>009-26685</b>	Fits older Sears 12-in. Band Saws 009-22412: Mild scroll cuts in hard/soft wood from 3/8-in. to 3-in. thick	5	<b>14.99</b>
Hard Edge/Flex Back 91-in. x 1/2-in. x .025 x 3T Hook	<b>009-26686</b>	Fits older Sears 12-in. Band Saws 009-22412: Re-saw cuts in hard/soft wood up to 5-in. thick	8	<b>14.99</b>
Hard Edge/Flex Back 93 1/2-in. x 3/16-in. x .025 x 10T Reg.	<b>009-26687</b>	Fits all popular 14-in. Band Saws (check manual): Mild scroll cuts in hard/soft wood from 3/8-in. to 3-in. thick	5	<b>14.99</b>
Hard Edge/Flex Back 93 1/2-in. x 1/2-in. x .025 x 3T	<b>009-26688</b>	Fits all popular 14-in. Band Saws (check manual): Re-saw cuts in hard/soft wood up to 5-in. thick	8	<b>14.99</b>
Wood Band 62-in. x 1/8-in. x .018 x 14T Hook	<b>009-21792</b>	Fits Sears 9-in. Bench Top Band Saw 21419: Tight scroll cuts in wood from 1/4-in. to 2-in. thick	3	<b>12.49</b>
Wood Band 62-in. x 1/4-in. x .014 x 6T Hook	<b>009-21793</b>	Fits Sears 9-in. Bench Top Band Saw 21419: General purpose cuts in wood from 1/2-in. to 3-in. thick	4	<b>12.49</b>
Wood Band 62-in. x 3/8-in. x .014 x 4T Hook	<b>009-21794</b>	Fits Sears 9-in. Bench Top Band Saw 21419: Mild contour cuts in wood from 3/4-in. to 3 1/2-in. thick	4	<b>12.49</b>

# bench power tools



**CRAFTSMAN**<sup>®</sup>**PROFESSIONAL**

# band saw blades

**Craftsman® Professional Band Saw Blades**

Description	Catalog No.	Application	Wt. oz.	Price
Commercial Grade – 70 1/2-in. x 1/8-in. x .025 x 14T Reg.	<b>009-29556</b>	Fits Sears 10-in. Band Saw 21400 Tight scroll cuts in hard/soft wood from 1/4-in to 2-in. thick	4	<b>\$16.99</b>
Commercial Grade – 70 1/2-in. x 3/16-in. x .025 x 10T Reg.	<b>009-29557</b>	Fits Sears 10-in. Band Saw 21400 Mild scroll cuts in hard/soft wood from 3/8-in to 3-in. thick	4	<b>16.99</b>
Commercial Grade – 70 1/2-in. x 1/4-in. x .025 x 6T Skip	<b>009-29558</b>	Fits Sears 10-in. Band Saw 21400 General purpose cuts in hard/soft wood from 1/2-in to 4-in. thick	5	<b>16.99</b>
Commercial Grade – 70 1/2-in. x 3/8-in. x .025 x 4T Skip	<b>009-29559</b>	Fits Sears 10-in. Band Saw 21400 Mild contour cuts in hard/soft wood from 3/4-in to 4 5/8-in. thick	6	<b>16.99</b>
Commercial Grade – 70 1/2-in. x 1/2-in. x .025 x 3T Hook	<b>009-29560</b>	Fits Sears 10-in. Band Saw 21400 Re-saw cuts in hard/soft wood from 1-in to 4 5/8-in. thick	7	<b>16.99</b>
Commercial Grade – 89 1/2-in. x 1/8-in. x .025 x 14T Reg.	<b>009-29551</b>	Fits Sears 12-in. Band Saw 22400 Tight scroll cuts in hard/soft wood from 1/4-in to 2-in. thick	5	<b>20.49</b>
Commercial Grade – 89 1/2-in. x 3/16-in. x .025 x 10T Reg.	<b>009-29552</b>	Fits Sears 12-in. Band Saw 22400 Mild scroll cuts in hard/soft wood from 3/8-in to 3-in. thick	5	<b>16.99</b>
Commercial Grade – 89 1/2-in. x 1/4-in. x .025 x 6T Skip	<b>009-29553</b>	Fits Sears 12-in. Band Saw 22400 General purpose cuts in hard/soft wood from 1/2-in to 4-in. thick	6	<b>18.49</b>
Commercial Grade – 89 1/2-in. x 3/8-in. x .025 x 4T Skip	<b>009-29554</b>	Fits Sears 12-in. Band Saw 22400 Mild contour cuts in hard/soft wood from 3/4-in to 5-in. thick	6	<b>19.49</b>
Commercial Grade – 89 1/2-in. x 1/2-in. x .025 x 3T Hook	<b>009-29555</b>	Fits Sears 12-in. Band Saw 22400 Re-saw cuts in hard/soft wood from 1-in. to 7-in. thick	7	<b>17.99</b>
3-blade pack Commercial Grade Asst.– 89 1/2-in. x 1/8-in., 1/4-in., 1/2-in.	<b>009-29364</b>	Fits Sears 12-in. Band Saw 22400 Tight scroll, general purpose and re-saw cuts in hard/soft wood	16	<b>49.99</b>
Commercial Grade – 99 3/4-in. x 1/8-in. x .025 x 14T Reg.	<b>009-29545</b>	Fits Sears 14-in. Band Saw 22401 Tight scroll cuts in hard/soft wood from 1/4-in to 2-in. thick	6	<b>20.49</b>
Commercial Grade – 99 3/4-in. x 3/16-in. x .025 x 10T Reg.	<b>009-29546</b>	Fits Sears 14-in. Band Saw 22401 Mild scroll cuts in hard/soft wood from 3/8-in to 3-in. thick	6	<b>20.49</b>
Commercial Grade – 99 3/4-in. x 1/4-in. x .025 x 6T Skip	<b>009-29547</b>	Fits Sears 14-in. Band Saw 22401 General purpose cuts in hard/soft wood from 1/2-in to 4-in. thick	7	<b>19.49</b>
Commercial Grade – 99 3/4-in. x 3/8-in. x .025 x 4T Skip	<b>009-29548</b>	Fits Sears 14-in. Band Saw 22401 Mild contour cuts in hard/soft wood from 3/4-in to 5-in. thick	7	<b>20.49</b>
Commercial Grade – 99 3/4-in. x 1/2-in. x .025 x 3T Hook	<b>009-29549</b>	Fits Sears 14-in. Band Saw 22401 Re-saw cuts in hard/soft wood from 1-in. to 8-in. thick	8	<b>19.99</b>
Commercial Grade – 99 3/4-in. x 3/4-in. x .032 x 2T Hook	<b>009-29550</b>	Fits Sears 14-in. Band Saw 22401 Heavy-duty re-saw cuts in hard/soft wood from 3-in. to 8-in. thick	16	<b>22.99</b>



# OPEN STOCK

## Craftsman® Professional Band Saw Blades

Description	Catalog No.	Application	Wt. oz.	Price
3-Blade pack, Commercial Grade Asst.-99 3/4-in. x 1/8-in., 1/4-in., 3/8-in. and 1/2-in.	<b>009-29365</b>	Fits Sears 14-in. Band Saw 22401 General purpose, mild contour and re-saw cuts in hard/soft wood	22	<b>\$56.99</b>
Hard Edge/Hard Back 140-in. x 1/4-in. x .025 x 18T Reg.	<b>009-29429</b>	Fits Sears 18-in. Industrial Metal Cutting Band Saw 21430: Cuts non-ferrous metal and mild steel 3/16-in.+	13.5	<b>21.99</b>
Hard Edge/Hard Back 140-in. x 1/2-in. x .025 x 14T Reg.	<b>009-29421</b>	Fits Sears 18-in. Industrial Metal Cutting Band Saw 21430: Cuts non-ferrous metal and mild steel 1/4-in.+	17.2	<b>21.99</b>
Bi-Metal 140-in. x 1/4-in. x .025 x 10/14 Vari Pitch	<b>009-29430</b>	Fits Sears 18-in. Industrial Metal Cutting Band Saw 21430: Cuts hardened steel and exotic metals 5/16-in.+	13.5	<b>68.99</b>
Bi-Metal 140-in. x 1/2-in. x .025 x 14/18 Vari Pitch	<b>009-29431</b>	Fits Sears 18-in. Industrial Metal Cutting Band Saw 21430: Cuts hardened steel and exotic metals 7/32-in.+	17.2	<b>68.99</b>
Hard Edge/Hard Back 120-in. x 1/4-in. x .025 x 18T Reg.	<b>009-29420</b>	Fits Sears 15-in. Industrial Metal Cutting Band Saw 21431: Cuts non-ferrous metal and mild steel 3/16-in.+	11.6	<b>21.99</b>
Hard Edge/Hard Back 120-in. x 1/2-in. x .025 x 14T Reg.	<b>009-29432</b>	Fits Sears 15-in. Industrial Metal Cutting Band Saw 21431: Cuts non-ferrous metal and mild steel 1/4-in.+	13.5	<b>21.99</b>
Bi-Metal 120-in. x 1/4-in. x .025 x 10/14 Vari Pitch	<b>009-29433</b>	Fits Sears 15-in. Industrial Metal Cutting Band Saw 21431: Cuts hardened steel and exotic metals 5/16-in.+	11.6	<b>68.99</b>
Bi-Metal 120-in. x 1/2-in. x .025 x 14/18 Vari Pitch	<b>009-29434</b>	Fits Sears 15-in. Industrial Metal Cutting Band Saw 21431: Cuts hardened steel and exotic metals 7/32-in.+	13.5	<b>68.99</b>
Hard Edge/Flex Back 136-in. x 3/16-in. x .025 x 10T Reg.	<b>009-29435</b>	Fits Sears 18-in. Wood/Metal Cutting Band Saw 22450: Mild scroll cuts in hard/soft wood from 3/8-in. to 3-in. thick	12.6	<b>22.99</b>
Hard Edge/Flex Back 136-in. x 1/4-in. x .025 x 6T Skip	<b>009-29436</b>	Fits Sears 18-in. Wood/Metal Cutting Band Saw 22450: General purpose cuts in hard/soft wood from 1/2-in. to 4-in. thick	13.6	<b>22.99</b>
Hard Edge/Flex Back 136-in. x 1/2-in. x .025 x 3T Hook	<b>009-29437</b>	Fits Sears 18-in. Wood/Metal Cutting Band Saw 22450: Re-saw cuts in hard/soft wood from 1-in. to 8-in. thick	15.6	<b>22.99</b>
Hard Edge/Flex Back 136-in. x 3/4-in. x .032 x 2T Hook	<b>009-29438</b>	Fits Sears 18-in. Wood/Metal Cutting Band Saw 22450: Heavy-duty re-saw cuts in hard/soft wood to 12-in. thick	20.8	<b>28.99</b>
Hard Edge/Hard Back 136-in. x 1/4-in. x .025 x 18T Reg.	<b>009-29439</b>	Fits Sears 18-in. Wood/Metal Cutting Band Saw 22450: Cuts non-ferrous metal and mild steel 3/16-in.+ thick	13.6	<b>23.99</b>
Hard Edge/Hard Back 136-in. x 1/2-in. x .025 x 14T Reg.	<b>009-29530</b>	Fits Sears 18-in. Wood/Metal Cutting Band Saw 22450: Cuts non-ferrous metal and mild steel 1/4-in.+ thick	15.6	<b>23.99</b>
Bi-Metal 136-in. x 1/4-in. x .025 x 10/14 Vari Pitch	<b>009-29532</b>	Fits Sears 18-in. Wood/Metal Cutting Band Saw 22450: Cuts hardened steel and exotic metals 5/16-in.+ thick	13.6	<b>65.99</b>
Bi-Metal 136-in. x 1/2-in. x .025 x 14/18 Vari Pitch	<b>009-29533</b>	Fits Sears 18-in. Wood/Metal Cutting Band Saw 22450: Cuts hardened steel and exotic metals 7/32-in.+ thick	15.6	<b>65.99</b>
Wood Band 63 1/2-in. x 1/4-in. x .014 x 10T Hook	<b>009-24143</b>	Fits Sears 10-in. Tilting Head Band Saw 21461: General purpose cuts in wood from 5/16-in. to 2-in. thick	4	<b>12.99</b>
Wood Band 63 1/2-in. x 1/4-in. x .014 x 6T	<b>009-24144</b>	Fits Sears 10-in. Tilting Head Band Saw 21461: General purpose cuts in wood from 1/2-in. to 3-in. thick	4	<b>12.99</b>
Wood Band 63 1/2-in. x 3/9-in. x .014 x 4T	<b>009-24145</b>	Fits Sears 10-in. Tilting Head Band Saw 21461: Mild contour cuts in wood from 3/4-in. to 3 1/2-in. thick	4	<b>12.99</b>

# bench power tools



Find the blades and blade sets made for your Craftsman® Sabre or Reciprocating Saws to keep them performing at their best.

## Blades and Blade Sets

### Sabre Saw Blades

Description	Catalog No.	Brand	Wt. lb.	Price
HCS 3 15/16 in. 8 TPI	009-64360	C	0.40	\$4.49
HCS 3 in. 14 TPI	009-64361	C	0.40	4.49
HCS 3 15/16 in. 10 TPI – Wood	009-64362	C	0.40	4.99
HCS 3 15/16 in. 10 TPI – All-Purpose	009-64363	C	0.40	4.49
HSS 3 in. 24 TPI Metal Jig Saw Blade 3 Pk.	009-64364	C	0.40	4.49
HSS 3 in. 14 TPI Metal Jig Saw Blade 3 Pk.	009-64365	C	0.40	4.49
HSS 3 15/16 in. 8 TPI Aluminum Jig Saw Blade 3 Pk.	009-64366	C	0.40	4.49
HCS 3 5/8 in. 8 TPI	009-64367	C	0.40	4.49
HCS 2 3/4 in. 14 TPI Metal Jig Saw Blade 3 Pk.	009-64368	C	0.40	4.49
HCS 3 5/8 in. 10 TPI	009-64369	C	0.40	4.99
HCS 3 18 in. 10 TPI	009-64370	C	0.40	4.49
HCS 2 3/4 in. 18 TPI Metal Jig Saw Blade 3 Pk.	009-64371	C	0.40	4.49
HCS 2 3/4 in. 14 TPI Metal Jig Saw Blade 3 Pk.	009-64372	C	0.40	4.49
3 in. 20 TPI BIM T-Shank Laminate Flooring Jig Saw Blade 5 Pk.	009-64379	CP	1.81	10.99

### Sabre Saw Blade Sets

T Set Multipurpose 5 Pc.	009-64373	C	1.81	\$7.99
T Set Variety with Soft Case 10 Pc.	009-64374	C	0.34	19.99
U Set Multipurpose 5 Pc.	009-64375	C	1.81	7.99
U Set Variety with Soft Case 15 Pc.	009-64376	C	0.94	19.99
T Set Multipurpose 5 Pc.	009-64386	CP	0.19	10.99
T Set Woodworking with Hard Case 20 Pc.	009-64387	CP	1.00	29.99

Brand: C – Craftsman; CP – Craftsman Professional





# OPEN STOCK

# sabre & reciprocating saw blades



### Blades and Blade Sets

#### Reciprocating Saw Blades

Description	Catalog No.	Brand	Wt. lb.	Price
BIM 6 in. 14 TPI Metal 2 Pk.	009-66380	C	0.13	\$4.99
BIM 9 in. 14 TPI Metal 2 Pk.	009-66381	C	0.13	6.99
Craftsman BIM 6 in. 18 TPI Metal 2 Pk.	009-66382	C	0.13	4.99
HCS 9 in. 5 TPI Wood-Pruning 2 Pk.	009-66383	C	0.13	6.99
HCS 9 in. 6 TPI Wood 2 Pk.	009-66384	C	0.13	6.99
HCS 6 in. 6 TPI Wood 2 Pk.	009-66385	C	0.13	4.99
BIM 6 in. 6 TPI Wood with Nails 2 Pk.	009-66386	C	0.13	5.99
BIM 9 in. 6 TPI Wood with Nails 2 Pk.	009-66387	C	0.13	7.99
BIM 6 in. 10/14 All-Purpose TPI 2 Pk.	009-66388	C	0.13	5.99
BIM 9 in. 10/14 All-Purpose TPI 2 Pk.	009-66389	C	0.13	7.99
8 in. 10 TPI Recip. Blade – Thick Metal	009-64490	CP	0.31	19.99
6 in. 6 TPI Recip. Blade Wood with Nails	009-64491	CP	0.19	18.99
9 in. 6 TPI Recip. Blade– Wood with Nails	009-64492	CP	0.31	19.99
12 in. 6 TPI Recip. Blade – Wood with Nails	009-64493	CP	3.25	24.99
6 in. 10/14 TPI Recip. Blade – All-Purpose Demolition	009-64494	CP	1.00	19.99
9 in. 10/14 TPI Recip. Blade – All-Purpose Demolition	009-64495	CP	1.00	19.99
12 in. 10/14 TPI Recip. Blade – All-Purpose Demolition	009-64496	CP	1.00	21.99
6 in. 7-18 TPI, Recip. Blade – Metal	009-64487	CP	0.19	7.99
8 in. 6-10 TPI Recip. Blade – Wood	009-64488	CP	0.19	8.99
8 in. 6-12 TPI Recip. Blade – All-Purpose	009-64489	CP	0.19	8.99

#### Reciprocating Saw Blade Sets

8 Pc. Set	009-66410	C	0.38	\$19.99
10 Pc. Set	009-66411	C	0.81	24.99
10 Pc. Set with Cloth Storage Pouch	009-64500	CP	1.00	32.99

Brand: C – Craftsman; CP – Craftsman Professional

portable power tools



## Craftsman® Wet/Dry Vac Accessories

Description	Catalog No.	Wt. lbs.	Price
<b>Hoses</b>			
7 ft. Combo Hose	009-16928	2.86	\$19.99
10 ft. Pro Hose	009-16932	4.20	39.99
13 ft. Pos-I-Lock Hose	009-17800	4.50	22.99
20 ft. Pos-I-Lock Hose	009-17814	6.98	24.99
2 1/2-in. x 20 ft. Hose	009-17821	6.38	21.99
2 1/2-in. x 13 ft. Hose	009-17829	4.28	19.99
1 7/8-in. x 7 ft. Hose	009-17825	1.95	17.99
1 1/4-in. x 6 ft. Hose	009-17866	1.12	14.99
<b>2 1/2-inch Accessories</b>			
2 1/2-in. Dusting Brush	009-16901	0.22	8.99
2 1/2-in. Crevice Tool	009-16902	0.20	7.99
2 1/2-in. Utility Nozzle	009-16922	0.16	9.99
2 1/2-in. Dry Nozzle	009-16925	0.38	12.99
2 1/2-in. Blower Nozzle	009-16933	0.16	7.99
2 1/2-in. Hose Grip	009-16934	0.46	9.99
2 1/2-in. Car Nozzle	009-16978	0.18	7.99
2 1/2-in. Extension Wand	009-17854	0.60	8.99
14-in. Floor Brush	009-16926	0.63	15.99
Muffler/Diffuser	009-16993	0.20	12.99
2 1/2-in. Wet Nozzle	009-17817	0.32	13.99
Carpet Nozzle	009-16955	0.68	12.99
Claw Nozzle	009-16956	0.30	9.99
2 1/2-in. 6-pc. Accessory Kit	009-16919	3.00	39.99
Gutter Kit	009-16935	2.70	19.99
5-pc. Car Cleaning Kit	009-16994	1.90	19.99
Deluxe Car Cleaning Kit	009-16989	3.65	39.99
Heavy Duty Accessory Kit	009-17833	5.35	49.99
<b>1 7/8-inch Accessories</b>			
1 7/8-in. Extension Wand	009-17834	0.30	7.99
1 7/8-in. Utility Nozzle	009-17835	0.10	6.99
1 7/8-in. Dusting Brush	009-17836	0.18	7.99
1 7/8-in. Crevice Tool	009-17838	0.16	6.99
1 7/8-in. Car Nozzle	009-17839	0.14	6.99
1 7/8-in. Wet Nozzle	009-17841	0.30	10.99
1 7/8-in. Floor Brush	009-17289	0.50	11.99
1 7/8-in. 3-pc. Accessory Kit	009-17864	0.87	14.99
1 7/8-in. 6-pc. Accessory Kit	009-16998	1.65	29.99
<b>1 1/4-inch Accessories</b>			
1 1/4-in. Dusting Brush	009-17862	0.12	6.99
1 1/4-in. Crevice Tool	009-17863	0.10	5.99
1 1/4-in. Car Nozzle	009-17868	0.08	5.99
1 1/4-in. Utility Nozzle	009-16921	0.16	5.99
1 1/4-in. Wet Nozzle/Floor Brush	009-16944	0.40	9.99
1 1/4-in. Extension Wand	009-17849	0.22	6.99
Micro Cleaning Kit	009-17493	0.22	14.99
1 1/4-in. 3-pc. Accessory Kit	009-17860	0.44	9.99
<b>Adapters/Connectors</b>			
Universal Tool Adapter	009-17837	0.26	9.99
2 1/2-in. to 1 1/4-in. Adapter	009-16999	0.08	4.99
3-pc. Adapter/Connector Kit	009-17827	0.28	8.99
2 1/2-in. Connector	009-16917	0.08	5.49
<b>Miscellaneous</b>			
Filter Plate	009-16937	0.18	5.99
Filter Nut	009-16938	0.02	2.99
Pump Out	009-16952	4.50	39.99

To keep your Wet/Dry Vac functioning at optimal performance, replace your filter on a regular basis. Simply locate the model # of your Vac, then choose the appropriate filter that fits your model and intended use. You can also select from a wide variety of Wet/Dry Vac Accessories for your specific application.



**CRAFTSMAN®** Share**OPEN  
STOCK****wet/dry vacs****filters & accessories****workshop solutions****Craftsman® Wet/Dry Vac Filters**

Description	Catalog No.	Details, Features	Wt. lbs.	Price
Red Stripe General Purpose Replacement Filter	<b>009-17816</b>	For use with 5-gallon and larger vacs made 1988 and after.	1.00	<b>\$16.99</b>
Fine Dust Replacement Filter	<b>009-17907</b>	99 percent efficient for particles down to 1 micron. For use with 5-gallon and larger vacs made 1988 and after.	1.00	<b>22.99</b>
HEPA Material Replacement Filter	<b>009-17912</b>	99.97 percent efficient for particles down to 0.3 microns. For use with 5-gallon and larger vacs made 1988 and after.	1.00	<b>29.99</b>
Purple Stripe General Purpose Replacement Filter (Half-Height)	<b>009-17810</b>	For use with 3 and 4-gallon vacs made 1988 and after.	0.56	<b>12.99</b>
Wet Application Vac Filter	<b>009-17292</b>	Wet pick-up only. For use with 5-gallon and larger vacs made 1986 and after.	1.00	<b>16.99</b>
HEPA Material Replacement Filter (Half-Height)	<b>009-16950</b>	99.97 percent efficient for particles down to 0.3 microns. For use with 3 and 4-gallon vacs made 1988 and after.	0.70	<b>24.99</b>
Green Stripe Replacement Filter	<b>009-17804</b>	For use with most 18 and 32-gallon vacs made before 1988.	2.10	<b>16.99</b>
Orange Stripe Replacement Filter	<b>009-17809</b>	For use with most 8, 16 and 32-gallon vacs made before 1988.	1.40	<b>16.99</b>
Blue Stripe Replacement Filter	<b>009-17812</b>	For use with most 5, 6, 8 and 12-gallon vacs made before 1988.	0.70	<b>16.99</b>
2-Gallon Filter Bag	<b>009-16949</b>	Fits most Craftsman 2-gallon vacs. Dry pickup only. Contents: 3 filter bags and retaining band.	0.19	<b>5.99</b>
12-Gallon High Efficiency Filter Bag	<b>009-16954</b>	For use with Craftsman 12-gallon vacs. Captures fine dust and general dirt. Dry pickup only. Contents: 2 filter bags.	0.15	<b>12.99</b>
16/20-Gallon Standard Filter Bag	<b>009-17895</b>	Fits most 16 and 20-gallon Craftsman vacs. Captures general dirt and debris. Dry pickup only. Contents: 3 filter bags.	1.00	<b>11.99</b>
16/20-Gallon High Efficiency Filter Bag	<b>009-17896</b>	Fits most 16 and 20-gallon Craftsman vacs. Captures fine dust and general dirt. Dry pickup only. Contents: 2 filter bags.	1.00	<b>14.99</b>
16-Gallon Drum Liner	<b>009-16940</b>	Fits most 16-gallon Craftsman vacs. Does not fit 16-gallon low profile oval drum models. Contents: 5 liners.	0.70	<b>5.99</b>



# pneumatic nails & staples

## CRAFTSMAN®

A complete listing of Craftsman® fasteners, staples and nails for all framing, nailing and finishing on your to do list. Search by fastener type, size and the specific tool you are using.

### Staples and Nails—Online EXCLUSIVE

18-gauge, 1/4-in. crown staples for 009-18171, 009-18174, 009-18176 and 009-18396

Length in.	Catalog No.	Quantity per Box	Wt. lbs.	Price
1 1/8	009-18372	4,000	4.9	\$11.49
1 1/4	009-18373	4,000	5.1	13.99
1 1/2	009-18374†	4,000	6	15.99

18-gauge, 1/4-in. crown staples for 009-18171, 009-18174, 009-18176, 009-18396 and 009-18169.

1/2	009-18333‡	5,000	2.75	\$6.99
3/4	009-18334	5,000	3.9	8.99
7/8	009-18336	5,000	4.3	10.99
1	009-18371	4,000	4.6	9.99

20-gauge, 1/2-in. crown staples for 009-18170.

3/8	009-18330	5,000	1.5	\$6.99
1/2	009-18332	5,000	2.13	7.99
7/8	009-18331	5,000	2.8	8.99
1 in.	009-18379	4,000	2.9	9.99

23-gauge fine wire staples for 009-18291.

1/2	009-18310	10,000	1.5	\$13.99
5/8	009-18311	10,000	1.7	14.99

18-gauge brad nails for 009-18172 and 009-18174.

1 1/2	009-18360	5,000	3.75	\$12.99
1 3/4	009-18361##	5,000	4.5	12.99
2	009-18362##	5,000	5	13.99

18-gauge brad nails for 009-18172, 009-18173 and 009-18174.

3/8	009-18340◀	5,000	1	\$6.99
5/8	009-18341	5,000	1.56	7.99
1	009-18342	5,000	2.5	8.99
1 1/4	009-18343	5,000	3.19	9.99

23-gauge headless pins for 009-18292.

1/2	009-18312	10,000	0.9	\$6.49
5/8	009-18315	10,000	1	7.49
3/4	009-18316	10,000	1.1	8.49

15-gauge angle finish nails for 009-18177.

1 1/2	009-18348	4,000	6.25	\$26.99
2	009-18349	4,000	9	29.99
2 1/2	009-18355	3,000	10	27.99

16-gauge finishing nails for 009-18175 and 009-18176.

3/4	009-18345	5,000	4.38	\$12.99
1 1/4	009-18344	2,500	2.75	7.99
1 1/2	009-18346	2,500	3.38	8.99
2	009-18347	2,500	4.19	11.99
2 1/2	009-18368▶	2,500	5.7	13.99

16-gauge, 1/2-in. crown staples for 009-18410.

1 1/4	009-18326	5,000	9.5	\$23.99
1 1/2	009-18327	5,000	14	33.99
2	009-18328	5,000	17.13	39.99

† For use with 009-18174, 009-18176 and 009-18396.

‡ All except 009-18174 and 009-18176.

## For use with 009-18172. ◀ For use with 009-18173.

▶ For use with 009-18175.





Share

# OPEN STOCK

## Staples and Nails—Online EXCLUSIVE

### 14-gauge finish nails for 009-18290

Length In.	Catalog No.	Quantity per Box	Wt. lbs.	Price
1 1/4	009-18300	2,500	3.6	\$12.99
1 3/4	009-18302	2,500	4.7	18.99
2	009-18304	2,500	5.4	19.99

### T-head nails for 009-18290.

1 1/4	009-18294	1,000	2.1	\$12.99
1 3/4	009-18295	1,000	2.9	13.99
2	009-18296	1,000	3.4	14.99
2 1/4	009-18297	1,000	3.9	15.99

### Full-head framing nails for 009-18178.

2 3/8	009-18375	2,000	14.6	\$34.99
3	009-18376	1,000	11.3	31.99
3 1/4	009-18377	1,000	12.1	31.99
3 1/2	009-18378	1,000	13.6	37.49

### Clipped-head framing nails for interior use for 009-18179.

2 1/2	009-18351	2,000	18	\$37.49
3	009-18352	2,000	21	42.99
3 1/2	009-18353	2,000	26	53.99

### Clipped-head galvanized framing nails for 009-18179.

2 1/2	009-18357	1,000	8.75	\$21.99
3	009-18358	1,000	10.1	31.99
3 1/2	009-18359	1,000	12.4	37.49

### 16-gauge 1-in. crown staples for 009-18415.

1	009-18337	5,000	12	\$25.99
1 1/2	009-18338	5,000	16	33.99

### Full-head framing galvanized nails for 009-18178.

2 1/2	009-18078	2,000	15	\$23.99
3 1/4	009-18080	1,000	13	18.99

### Coiled nails galvanized for 009-18214.

1 3/4	009-18081	8,000	38	\$37.99
2	009-18082	6,000	42	41.99

### Coiled roofing nails for 009-18180.

1	009-18413	2,880	12	\$19.99
1 1/4	009-18414	2,880	14	21.99

### 18-gauge angle brad nails for 009-18181/009-18654.

1 3/16	009-18090	5,000	3.20	\$12.99
1 3/8	009-18091	5,000	3.55	14.99
1 5/8	009-18092	5,000	3.95	16.99
1 3/4	009-18093	5,000	4.50	18.99
2	009-18094	5,000	5.10	20.99

### Cable staples 1/2W x 5/32-9/32H in. for 009-18182.

—	009-18099	500	0.5	\$17.99
---	-----------	-----	-----	---------

### Cable staples 5/16-3/8 in. for 009-18182.

3/8-7/16H	009-18098	500	0.6	\$19.99
7/16-1/2H	009-18097	500	0.7	21.99

### 18-gauge, 1/4 in. crown staples for 009-18169

Size, In.	Catalog No.	Qty. Box	Wt. lbs.	Price, Box
1/2	009-18333	5,000	2.75	\$6.99
3/4	009-18334	5,000	3.90	8.99
7/8	009-18336	5,000	4.30	10.99
1	009-18371	4,000	4.60	9.99

# carpentry air tools





We offer these sanding belts, discs, strips and accessories to ensure you can find just what you're looking for to fit all the sanding tools in your workshop.

### Craftsman® Sanding Accessories

**Rubber Drum for Spindle Sander 009-21500 and Sanding Center 009-21516 and 009-21508**

Size, in.	Catalog No.	Wt. lbs.	Price
3/4	009-24131	0.15	\$3.99
1	009-24132	0.18	4.99
1 1/2	009-24133	0.22	5.99
2	009-24134	0.30	7.99
3	009-24136	0.60	8.99

**Sanding Sleeves for Spindle Sander 009-21500 and Sanding Center 009-21516 and 009-21508**  
3-pack: 1 coarse, 1 medium, 1 fine.

Size	Catalog No.	Wt. lbs.	Price
1/2	009-29569	0.10	\$4.99
3/4	009-24137	0.10	4.99
1	009-24138	0.13	5.49
1 1/2	009-24139	0.16	5.99
2	009-24140	0.20	8.99
3	009-24142	0.30	12.99

**21-pc Sanding Drum Kit**  
for use with drill presses and portable drills

Size	Catalog No.	Wt. lbs.	Price
various	009-25262	2.40	\$19.99

### Craftsman® Sanding Belts

**Heavy-Duty Cloth-Backed Aluminum-Oxide Belts For Bench-Style and Belt/Disc Sanders.** Use for heavy stock removal, deburring of metal, dimensioning and shaping, finish sanding and polishing. Can be used for sanding wood, metal, plastic, fiberglass. Butt-spliced allows belt to run in both directions to extend usable belt life.

Size, in.	Grade	Pkg. of	Catalog No.	Wt. lb.	Price
1 x 30	Assorted	3	009-28413	0.22	\$4.29
1 x 42	Fine (120)	3	009-28409	0.38	6.19
1 x 42	Med (80)	3	009-28410	0.38	12.99
2 x 42	Fine (120)	3	009-28480	0.4	9.59
2 x 42	Med (80)	3	009-28481	0.4	9.59
2 x 42	Coarse (50)	3	009-28482	0.4	8.99
4 x 36	Fine (120)	1	009-28394	0.2	4.99
4 x 36	Med (80)	1	009-28395	0.2	4.99
4 x 36	Coarse (50)	1	009-28396	0.2	4.99
6 x 48	Fine (120)	1	009-28403	0.5	7.99
6 x 48	Med (80)	1	009-28404	0.5	7.99
6 x 48	Coarse (50)	1	009-28405	0.5	7.99

**Zirconia Alumina Resin Bond Heavy-Duty Cloth-Backed Belts for Bench-Style Belt and Belt/Disc Sanders.**  
Premium replacement belts feature a longer-lasting self-sharpening zirconia-aluminum abrasive coating.

Size, in.	Grade	Pkg. of	Catalog No.	Wt. lb.	Price
6 x 48	Fine (120)	1	009-28241	0.5	\$9.99
6 x 48	Med (80)	1	009-28242	0.5	9.99
6 x 48	Coarse (50)	1	009-28244	0.5	9.99

# bench power & specialty accessories

### Craftsman® Sanding Discs

**Aluminum-Oxide Paper Adhesive-Backed Sanding Discs.** Durable sharp aluminum oxide abrasive for aggressive, cool cut. Clog-resistant coating. Pressure-sensitive adhesive allows for quick and easy disc change.

Size, in.	Grade	Pkg. of	Catalog No.	Wt. lb.	Price
6-in., no hole	Assorted	5	009-28973	0.30	\$3.49
8-in., no hole	Assorted	6	009-28318	0.63	4.99
9-in., no hole	Assorted	4	009-28963	0.24	5.99
10-in., 3-in. hole	Assorted	6	009-28969	0.35	29.99

Need chisels, bits or accessories for cutting mortise and tenon joints? You'll find just what you need here.

### Craftsman® Bits and Chisels

**Mortising Bits**

Size, in.	Catalog No.	Wt. lbs.	Price
1/4	009-26411	0.1	\$7.99
5/16	009-26412	0.1	7.99
3/8	009-26413	0.1	7.99
1/2	009-26414	0.1	7.99

**Mortising Chisels**

Size, in.	Catalog No.	Wt. lbs.	Price
1/4	009-26415	0.2	\$14.99
5/16	009-26416	0.2	14.99
3/8	009-26417	0.2	14.99
1/2	009-26418	0.3	14.99



### Craftsman® Package of Extra Sleeves

Size, in.	No. of sleeves	Catalog No.	Wt. lbs.	Price, Pkg.
	coarse med. fine			
1/2 x 1/2	10 15 15	009-25307	0.06	\$5.99
3/4 x 1	7 14 14	009-25308	0.19	5.99
1 x 1	6 10 10	009-25309	0.21	5.99
1 1/2 x 1 1/2	5 5 5	009-25310	0.25	5.99
2 x 1 1/2	4 5 5	009-25311	0.25	5.99



# CRAFTSMAN®



A



Yellow



B



Orange



C



B D



## A. Craftsman® ANSI 107-2010 Reflective Full-Zip Hooded Sweatshirt

Highest rated ANSI Class 3 Hi Visibility shell is 100% polyester with Teflon® fabric protector and a durable Tricot lining. Ribbed knit waist and cuffs, heavy-duty brass zipper and 2 front kangaroo pockets. Machine washable. Imported. Two-year wear-out warranty.\*

**Regular Sizes:** M, L, XL, 2XL  
**041-25080** Orange  
**041-25081** Yellow  
**69.99 Sale 39.99**

## B. Craftsman Hi-Vis ANSI 107-2010 T-Shirt

Heavy-duty 6.5-oz. 100% polyester shirt has Teflon® fabric protector and highest Hi Vis ANSI Class 3 rating. With chest pocket, knit cuffs. Machine washable. Imported. Two-year wear-out warranty.\*

**Long Sleeve**  
**Regular Sizes:** M, L, XL, 2XL  
**041-25602** Yellow  
**041-25603** Orange  
(Not shown)  
**27.99 Sale 19.99**

**Short Sleeve**  
**Regular Sizes:** M, L, XL, 2XL  
**041-25601** Orange  
**041-25600** Yellow (Not shown)  
**24.99 Sale 17.99**

## C. Craftsman Reflective 3-in-1 Safety Jacket

ANSI Class 3 107-2010 compliant 100% nylon shell with Teflon® fabric protector and zip-out Tricot lining. Snap off hood, oversize front pockets, storm flap and heavy-duty brass zipper. Machine washable. 100% microfleece lining. Imported. Two-year wear-out warranty.\*

**Regular Sizes:** M, L, XL, 2XL  
**041-25102** Yellow  
**041-25103** Orange  
**99.99 Sale 59.99**

Available in select stores and online.

## D. Craftsman Hi-Vis ANSI 107-2010 Class 2 Vest

100% polyester vest has adjustable side straps, an inside pocket and heavy-duty Velcro® front closure. Machine washable. Imported. Two-year wear-out warranty.\*

**Regular Sizes:** M, L, XL, 2XL  
**041-25083** Yellow  
**041-25082** Orange  
(Not shown)  
**24.99 Sale 14.99**

\*See page 112 for warranty details.

# workwear

DuPont™  
Teflon®  
fabric protector

Teflon® is a registered trademark of DuPont used under license by Sears Holdings Corporation. See page xx.

# HI-VIS

shopyourway  
rewards join now. earn today. it's free. 145



# CRAFTSMAN®



A  
+  
**CRAFTSMAN JEANS**  
**\$19.99**

Dark Stone

**A. Craftsman® Carpenter Jean**  
Made for work in 13-oz. cotton with triple-needle stitching, heavy-duty twill-lined pockets and Teflon® fabric protector built into the fabric. Looser at seat and thigh for movement. Hammer loop. Zip-front fly. Machine washable. Imported. Two-year wear-out warranty.\*

(Even sizes)  
30 and 32 Inseam, Waist 32 – 44  
34 Inseam, Waist 32 – 40  
**041-27268** Stonewash  
**041-27269** Dark Stone  
**30.00 Sale 19.99**

**B. Craftsman 5-Pocket Jean**  
Heavy-duty 13-oz cotton denim. With triple-needle stitching. Heavy-duty twill pocketing and Repel Teflon® fabric protector built into fabric. Relaxed fit. Machine washable. Imported. Two-year wear-out warranty.\*

(Even sizes)  
30 and 32 Inseam, Waist 32 – 44  
34 Inseam, Waist 32 – 40  
**041-27263** Dark Stone  
**041-27262** Stonewash  
**26.00 Sale 19.99**

Teflon® is a registered trademark of DuPont used under license by Sears Holdings Corporation.



Charcoal

Black

Khaki

Navy



Dark Stone

Stonewash



Khaki

Dark Brown

**C. Craftsman Canvas Carpenter Jean**

Relaxed fit 10-oz. 100% cotton canvas pant with Teflon® fabric protector, dual tool pocket, hammer loop, heavy duty brass zipper. Machine washable. Imported. Two-year wear-out warranty.\* (Even sizes)  
30" and 32" Inseam, Waist 30" – 44"  
34" Inseam, Waist 32" – 40"  
**041-25776** Dark Brown  
**041-25778** Khaki  
**26.99 Sale 21.99**

**D. Craftsman Twill Work Pant**

Comfortable 55/45 Cotton/ Poly blend has Teflon® fabric protector and resists wrinkles. Machine washable. Imported. Two-year wear-out warranty.\* (Even sizes)  
30" and 32" Inseam, Waist 30" – 44"  
34" Inseam, Waist 32" – 40"  
**041-17052** Charcoal  
**041-16982** Black  
**041-17051** Khaki  
**041-17050** Navy  
**24.00 Sale 19.99**

\*See page 112 for warranty details.

**Craftsman® with Teflon® makes dirty workwear history.**

You and your workwear go through a lot together, so all Craftsman® Workwear is protected by Teflon® fabric protector:

**Repels liquids**

**Fewer stains**

**Less washing**



**E. Craftsman Long-Sleeve Twill Shirt**

Tough, durable twill with Teflon® fabric protector built into the fabric to repel water, oil and stains. Wrinkle-resistant for a smooth finish. Two button-through chest pockets with handy pencil stall. 55% cotton/45% polyester. Machine washable. Imported. Two-year wear-out warranty.\*

Regular Sizes: M, L, XL, 2XL

**Long-Sleeve Workshirt**

- 041-17057 Charcoal
- 041-16980 Black
- 041-17056 Khaki
- 041-17055 Navy
- 22.00 **Sale 16.99**

**Short-Sleeve Workshirt**

- (Not shown)
- 041-17062 Charcoal
  - 041-16981 Black
  - 041-17062 Khaki
  - 041-17061 Navy
  - 20.00 **Sale 14.99**



F  
+

- Navy
- Black
- Charcoal

**CRAFTSMAN®**

**F. Craftsman Short-Sleeve Coverall**

This 55/45 cotton/poly coverall features rugged double needle construction and reinforced stitching. Covered, zippered pockets, double front closure with snaps and 2-way zipper. Elastic waist for comfort. Machine washable. Imported.

Two-year wear-out warranty.\*

Regular Sizes: M(40-42), L(44-46), XL(48-50), 2XL(52-54)

**Short-Sleeve Coverall**

- 041-25787 Navy
- 041-25790 Black
- 041-25607 Charcoal
- 29.99 **Sale 24.99**

**Long-Sleeve Coverall**

(Not shown)

- 041-17065 Navy
- 041-25781 Black
- 041-25780 Charcoal
- 39.99 **Sale 34.99**



**workwear**



**G. Craftsman Short-Sleeve Henley**

Classic three-button henley with Teflon® fabric protector built into the fabric. Overlock stitching for toughness. Jersey knit 100% cotton. Machine washable. Imported. Two-year wear-out warranty.\*

Regular Sizes: M, L, XL, 2XL

- 041-16251 Navy
- 041-16252 Heather Gray
- 041-16250 Black
- 14.99 **Sale 9.99**

**H. Craftsman Pocket Tee**

Stains won't stick to this work tee with Teflon® fabric protector built into the fabric. Classic one-pocket style. 100% cotton. Chest pocket features Craftsman logo. Machine washable. Imported. Two-year wear-out warranty.\*

Regular Sizes: M, L, XL, 2XL

- 041-16258 Heather Gray
- 041-16257 Navy
- 041-16256 Black
- 14.99 **Sale 9.99**

**J. Craftsman Work Bib**

Classic work overalls with tough Teflon® fabric protector built into the fabric. Durable 12-oz. denim. Super strong twill pockets. Triple-needle stitching. Bar-tack stress points. Oversized utility pocket. Hammer loop. Machine washable. Imported. Two-year wear-out warranty.\*

(Even sizes)  
30" Inseam, Waist 34" - 54"  
32" Inseam, Waist 34" - 46"

- 041-17015 Stonewash
- 37.00 **Sale 29.99**

