

■ Embedded Power for
Business-Critical Continuity™

Embedded Power AC–DC and DC–DC Products

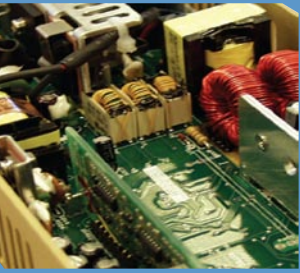

EMERSON™
Network Power



Contents

AC-DC Power Supplies

Low Power 2-500 W	
■ Open frame/enclosed 1-4 outputs	7
■ External power adapters	13
Healthcare Power Up to 4860 W	
■ 1-21 outputs	16
Medium Power (MP) Up to 1200 W	
■ 1-10 outputs standard (up to 21 available)	20
Intelligent Medium Power (iMP) Up to 1500 W	
■ Up to 21 outputs	23
Intelligent High Power (iVS) Up to 4920 W	
■ 1-18 outputs	27
Bulk Power (HPS & UFE) 350-6000 W	
■ Available 1U and 3U	31
<i>Compatible racks hold up to 4 modules</i>	
Distributed Power (DS) 450-2900 W	
■ Available 1U and 2U	34
<i>Compatible racks hold up to 5 modules</i>	
DIN Rail (ADN) 24 V 120-480 W	
■ Slim DIN rail format with PFC	39
<i>SEMI F47 and Hazardous Locations</i>	
MicroTCA 600 W	
■ MTC600 Series	40

DC-DC Converters

ATCA Modules	
■ Bus Converters	44
Industry Standard Isolated	
■ Sixteenth-Brick	45
■ Eighth-Brick	46
■ Quarter-Brick	47
■ Half-Brick	49
■ RF Power Brick	50
■ Bus Converters	51
Industry Standard Non-Isolated	
■ C-Class	52
■ E-Class	55
■ F-Class	56
■ POLA Products	57
■ Memory Power	59
■ VRM Processor Power	59
High Power 300 V Input	
■ Power Factor Correction (PFC)	60
■ 300 V Full-Brick	60
■ 300 V Half-Brick	60
■ 300 V Quarter-Brick	60
Low Power Industrial	
■ Industrial Standard Products	62
Terms and Conditions	64
Index	66

For additional Information go to
Emerson.com/EmbeddedPower



The Embedded Power business of Emerson Network Power offers thousands of standard, modified and custom power supply products. Every standard product in our extensive portfolio is designed to help speed time to market more cost effectively and with less risk.

Emerson Network Power's global view of power provides you with an unprecedented level of supply and support.

Our research, development, sales and support teams throughout the world are dedicated to meeting your needs today and in the future with innovative power solutions. We have invested in state-of-the-art manufacturing facilities and advanced global distribution systems to quickly manufacture and deliver the power products you need. We can quickly respond to your changing demands and have the ability to support you locally or worldwide.

Uniting the well-known Astec and Artesyn brands, the combined strength and experience of these companies, fused with pedigrees of quality, innovation and a deep understanding of our customers' needs, positions Emerson Network Power for continued growth and leadership in the embedded power markets.

This catalog lists key performance data for all standard ac-dc power supplies and dc-dc converters from the Embedded Power business of Emerson Network Power. It is designed to provide you with a fast, easy-to-use means of identifying the ideal power source for your application.

After selecting the product that you need from this catalog, we recommend that you visit our website to obtain more detailed information. You will find that you can quickly download product datasheets and safety certificates, check stock levels at our extensive global distribution network, and request evaluation samples. You can even ask one of our experts for technical advice, or register for the 'MyPower' community portal to gain access to tools, a knowledge base and support to help guide you to the best power solution for your needs.

Local Support

Our regional sales offices are ready to provide expert local applications and sales support. In addition, an extensive network of manufacturers' representatives and distributors bring our products to you. Please call for locations of sales offices near you or visit our website at Emerson.com/EmbeddedPower.

Americas (USA)

Telephone: +1 760 930 4600
Facsimile: +1 760 930 0698

Europe (UK)

Telephone: +44 (0) 1384 842 211
Facsimile: +44 (0) 1384 843 355

Asia (HK)

Telephone: +852 2176 3333
Facsimile: +852 2176 3888

Technical Support

Americas (USA)

+1 888 412 7832 (North America)

Europe, Middle East and Africa (EMEA)

0 800 0321546 (in the UK)
+44 800 0321546 (outside the UK)

Asia

+400 88 99 130 (China)
+86 29 8883 6505 (outside China)

Email:

America and EMEA
techsupport.embeddedpower@emerson.com

Asia

TSXA.embeddedpower@emerson.com



For additional information go to
Emerson.com/EmbeddedPower



Accelerate, Improve & Enhance the Capabilities of Your Next Power Product

At Emerson Network Power – Embedded Power, our engineers have been designing and developing power supply products for over 35 years. Our products have helped pave the way for advancements in numerous applications in the communications, industrial, computing, data storage and healthcare markets.

When developing product, time is money. Every step in the process that you can eliminate, speed up, or make more effective accelerates your time to market and lowers your R&D costs. Major advantages of partnering with Emerson Network Power include:

- Broadest power supply product lines
- Highly versatile power supplies
- Low energy consumption
- Eco-friendly products
- Space-efficient power
- Reliability & quality
- Worldwide distributor network
- Vast knowledge, experience & expertise

Innovation for the Next Generation

Many of our new products incorporate powerful programming, monitoring and self-testing software that provide system engineers with critical data to manage power consumption. High efficiency, green design and manufacturing technologies, and innovative demand and supply replenishment systems collectively deliver key business efficiencies and new design capabilities. All aimed at helping your company increase its overall return on investment. Emerson Network Power can help take your new product design or redevelopment efforts to the next level with a shorter time-to-profit, higher reliability and greater scalability. Emerson benefits include:

- **Shorter Time-to-Market** – our latest programmable power solutions – such as our line of FPGA power products and our modular, medium/high power iMP series provide you with a shorter time-to-market and offer faster test and qualification than traditional analog power solutions, at a cost which rivals less flexible power supplies.
- **Higher Reliability** – moving from inflexible fixed-output analog power supplies to programmable power solutions enables our engineers to more extensively test and document our products to ensure they meet or exceed your reliability requirements. And we provide a wide range of on-line environmental, EMC compliance and safety certification to help speed your product design process.
- **Greater Scalability** – many of our latest power solutions are scalable, programmable and plug-compatible with our earlier-generation products, enabling you to quickly address changes or enhancements to your systems. You can now satisfy most changes in power requirements simply by reprogramming the power supply – and if your needs change radically, you can easily swap to a more capable solution. This inherent scalability eliminates redesign costs, reduces testing time and provides you with greater design flexibility.

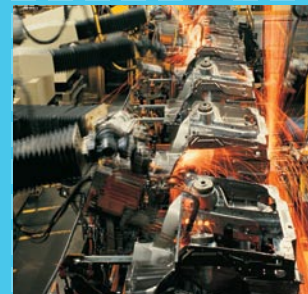
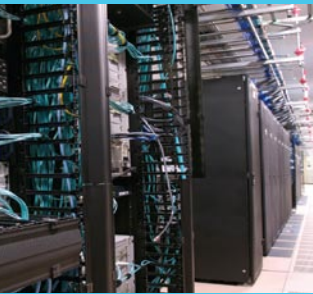

MyPower Community Portal

Discover. Communicate. Collaborate.

MyPower is a free community portal that provides a variety of tools and resources including:

Community

Utilizing the tools and resources provided will increase your standard knowledge base of our industry. Resources include:

- Industry Links
- What's New
- Trade Shows
- Tools & Calculators



Knowledge Base

Familiarize yourself with our products and services. This section is designed to help build your industry knowledge.

- Product Videos
- White Papers
- Industry Books
- Educational Product Videos



Support

Emerson Network Power strives to support your needs. In this section you will find:

- Factory Quality, Safety and Environmental Certifications



To sign up for a free MyPower account go to Emerson.com/MyPower



Stay Connected.

The latest happenings are being posted on Twitter, Facebook and YouTube! Sign up for one or all of the sites below and stay connected with Emerson Network Power – Embedded Power!

www.twitter.com/EmersonEmPower

www.facebook.com/pages/Emerson-Network-Power-Power-Supplies/53805116595

www.youtube.com/user/EmersonNetworkPower



AC-DC Power Supplies

Emerson Network Power is widely acknowledged as an industry leader and produces an exceptionally wide range of AC-DC power conversion products.



Low Power

Open frame/enclosed 1-4 outputs

25-500 Watts

Special Features

All models feature:

- Industry standard footprints
- Wide-range AC input
- Full power to 50 °C
- High demonstrated MTBF
- Overvoltage protection
- Overload protection
- Built-in EMI filtering
- Extensive safety approvals
- Derated operation to 70 °C

Many models feature:

- EN61000-3-2 compliance
- Supervisory outputs (5 V/12 V)
- Wide-adjust floating 4th output
- Single wire current share
- Medical approvals
- Remote sense
- Adjustable outputs
- Power fail
- Wide-adjust on single output models
- Derated operation to 80 °C



Output Power		Output				Size W x L x H (mm)	Model
[Forced Air]	Free Air	V1	V2	V3	V4		
[25 W]	25 W	NLP25 Series					
						2.07" x 4" x 0.91"	NLP25-7605J
						(52.57 x 101.6 x 23.2)	NLP25-7612J
							NLP25-7624J
							NLP25-7617J
[20 W]	20 W	5 V @ 2 A	12 V @ 0.8 A				NLP25-7629J
		5 V @ 2 A	12 V @ 0.8 A	-5 V @ 0.1 A			NLP25-7607J
		5 V @ 2 A	12 V @ 0.8 A	-12 V @ 0.1 A			NLP25-7608J
[40 W]	25 W	LP20 Series					
						3" x 5" x 1.2"	LPS22
						(76.2 x 127 x 30.5)	LPS23
							LPS24
							LPS25
			5 V @ 3 A [4A]	12 V @ 1.5 A [2A]	-12 V @ 0.5 A [0.7 A]		LPT22
			5 V @ 4 A [5A]	12 V @ 0.5 A [0.7 A]	-12 V @ 0.5 A [0.7 A]		LPT23
			5 V @ 3 A [4A]	12 V @ 1.5 A [2A]	-5 V @ 0.5 A [0.7 A]		LPT24
			5 V @ 3 A [4A]	15 V @ 1.5 A [2A]	-15 V @ 0.5 A [0.7 A]		LPT25
		[47 W]	Enclosed	LCT43-E			
5 V @ 4 A [7A]	12 V @ 1 A [1.2 A]			-12 V @ 0.5 A [0.5 A]		3.2" x 6.2" x 1.5"	LCT43-E
						(81.3 x 157.5 x 38.1)	
[50 W]	40 W	NLP40 Series					
						2.5" x 4.25" x 1.15"	NLP40-76S3J
						(63.5 x 108 x 29.2)	NLP40-7612J
							NLP40-7605J
							NLP40-7612J
							NLP40-7615J
							NLP40-7624J
							NLP40-7617J
			5 V @ 4.5 A	12 V @ 3 A			NLP40-7629J
			12 V @ 2.1 A	-12 V @ 2.1 A			NLP40-7627J
			3.3 V @ 4.5 A	12 V @ 3 A	-12 V @ 0.5 A		NLP40-76T366J
			5 V @ 4.5 A	12 V @ 3 A	-12 V @ 0.5 A		NLP40-7608J
			5 V @ 4.5 A	15 V @ 2 A	-15 V @ 0.5 A		NLP40-7610J

Options:

[] Rating with 30 CFM of air

(1) Optional cover/enclosure

* Floating output

Output Power		Output				Size W x L x H (mm)	Model		
[Forced Air]	Free Air	V1	V2	V3	V4				
[50 W]  (1)	40 W	NFS40 Series				3" x 5" x 1.2" (76.2 x 127 x 30.5)			
		3.3V@8A*						NFS40-7653J	
		5.1V@8A*						NFS40-7605J	
		12V@4A*						NFS40-7612J	
		15V@3.3A*						NFS40-7615J	
		24V@2A*						NFS40-7624J	
		5.1V@5A		12V@0.5A	-12V@0.5A			NFS40-7628J	
		5.1V@5A		12V@2A	-5V@0.5A			NFS40-7607J	
		5.1V@5A		12V@2A	-12V@0.5A			NFS40-7608J	
		5.1V@5A		15V@2A	-15V@0.5A			NFS40-7610J	
[55 W]  (1)	40 W	LP40 Series				3" x 5" x 1.2" (76.2 x 127 x 30.5)			
		3.3V@8A[11A]*						LPS41	
		5V@8A[11A]*						LPS42	
		12V@3.3A[4.5]*						LPS43	
		15V@2.6A[3.6A]*						LPS44	
		24V@1.6A[2.3A]*						LPS45	
		48V@0.9A[1.2A]*						LPS48	
		3.3V@4A[7A]		5V@1.5A[2A]	+12V@0.5A[0.7A]			LPT41	
		5V@4A[5A]		12V@2A[2.5A]	-12V@0.5A[0.7A]			LPT42	
		5V@6A[8A]		12V@0.5A[0.7A]	-12V@0.5A[0.7A]			LPT43	
		5V@4A[5A]		12V@2A[2.5A]	-5V@0.5A[0.7A]			LPT44	
		5V@4A[5A]		15V@2A[2.5A]	-15V@0.5A[0.7A]			LPT45	
		5V@4A[5A]		24V@1A[1.5A]	+12V@0.5A[0.7A]			LPT46	
		[60 W]  (1)	45 W	NPS40-M Series				2" x 4" x 1" (50.8 x 101.6 x 25.4)	
5V@8A[11A]				NPS42-M					
12V@3.75A[5A]				NPS43-M					
15V@3A[4A]				NPS44-M					
24V@1.9A[2.5A]				NPS45-M					
48V@0.94A[1.25A]				NPS48-M					
[55 W]  (1)	55 W	LP50 Series				2" x 4" x 1.3" (50.8 x 101.6 x 33)			
		3.3V@8A		5V@3A	12V@0.5A			LPT51	
		5V@8A		12V@3A	-12V@0.5A			LPT52	
		5V@8A		15V@2.4A	-15V@0.5A			LPT53	
		5V@8A		24V@1.5A	12V@0.5A			LPT54	
[60 W]  (1)	60 W	5V@11A*				2" x 4" x 1.3" (50.8 x 101.6 x 33)			
		5V@11A*						LPS52	
		12V@5A*						LPS52 (-I)	
		12V@5A*						LPS53	
		12V@5A*						LPS53 (-I)	
		15V@4A*						LPS54	
		24V@2.5A*						LPS55	
48V@1.25A*				LPS58					

Options:

[] Rating with 30 CFM of air

(1) Optional cover/enclosure

* Floating output

(-I) Industrial version -40 °C up to 80 °C (derated)

Output Power		Output				Size W x L x H (mm)	Model	
[Forced Air]	Free Air	V1	V2	V3	V4			
[75 W]	65 W	NLP65 Series						
			5 V@12 A*				3" x 5" x 1.26"	NLP65-7605J
			5 V@12 A*				(76.2 x 127 x 32)	NLP65-9605J ^{(5)G}
			12 V@6.5 A*					NLP65-7612J G
			12 V@6.5 A*					NLP65-9612J ^{(5)G}
			24 V@3.5 A*					NLP65-7624J G
			24 V@3.5 A*					NLP65-9624J ^{(5)G}
			5 V@8 A	12 V@3 A				NLP65-7629J
			5 V@8 A	12 V@3 A				NLP65-9629J ^{(5)G}
			5 V@8 A	24 V@2 A	+12 V@1.0 A			NLP65-3322J
			5 V@8 A	12 V@3 A	-12 V@0.8 A			NLP65-7608J G
			5 V@8 A	12 V@3 A	-12 V@0.8 A			NLP65-9608J ^{(5)E, G}
			5 V@8 A	15 V@2.5 A	-15 V@0.8 A			NLP65-7610GJ
			5 V@8 A	15 V@2.5 A	-15 V@0.8 A			NLP65-9610J ^{(5)G}
			5 V@8 A	24 V@2 A				NLP65-7620J
	5 V@8 A	24 V@2 A				NLP65-9620J ^{(5)G}		
[80 W]	60 W	LP60 Series						
			3.3 V@12 A [16 A]*				3" x 5" x 1.65"	LPS61
			5 V@12 A [16 A]*				(76.2 x 127 x 41.9)	LPS62
			12 V@5 A [6.7 A]*					LPS63
			15 V@4 A [5.3 A]*					LPS64
			24 V@2.5 A [3.3 A]*					LPS65
			48 V@1.3 A [1.7 A]*					LPS68
			3.3 V@5 A [8.5 A]	5 V@2.5 A [3 A]	+12 V@0.5 A [1 A]			LPT61
			5 V@7 A [8 A]	12 V@3 A [3.5 A]	-12 V@0.7 A [1 A]			LPT62
			5 V@7 A [8 A]	15 V@2.8 A [3.3 A]	-15 V@0.7 A [1 A]			LPT63
			5 V@7 A [8 A]	12 V@3 A [3.5 A]	-5 V@0.7 A [1 A]			LPT64
	5 V@7 A [8 A]	24 V@1.5 A [2 A]	+12 V@0.7 A [1 A]			LPT65		
[85 W]	60 W	LP80 Series						
			3.3 V@8 A [13 A] (1.8-3.5 V)	5 V@4 A [13 A] (3.3-5.5 V)	+12 V@0.7 A [1 A]		3" x 5" x 1.29" (76.2 x 127 x 82.8)	LPT81
			5 V@8 A [13 A] (3.3-5 V)	12 V@3 A [4 A]	-12 V@0.7 A [1 A]			LPT82
			5 V@8 A [13 A] (3.3-5 V)	15 V@2.4 A [3.2 A]	-15 V@0.7 A [1 A]			LPT83
[110 W]	80 W	LP110 Series						
			12 V@6.7 A [9.2 A]*				4" x 7" x 1.8"	LPS113
			15 V@5.3 A [7.3 A]*				(101.6 x 177.8 x 45.7)	LPS114
			24 V@3.3 A [4.6 A]*					LPS115
			48 V@1.7 A [2.3 A]*					LPS118
			5 V@9 A [11 A]	12 V@4.5 A [5 A]	-12 V@0.7 A [1 A]	±5-25 V@2.5 A [3 A]*		LPQ112
			5 V@9 A [11 A]	15 V@4.5 A [5 A]	-15 V@0.7 A [1 A]	±5-25 V@2.5 A [3 A]*		LPQ113
			5 V@9 A [11 A]	12 V@4.5 A [5 A]	-12 V@0.7 A [1 A]	24 V@3.5 A [4.5 A]		LPQ114

Options:

- E To order an enclosed version of the NLP65-9608J, add suffix 'EJ' to the end of the model number, e.g., NLP65-9608EJ. The enclosed version includes: IEC connector, on/off switch, wire harness output connector and fitted cover.
- G A safety earth ground pin and ground choke are available as an option. To order, please add the suffix 'GJ' to the end of the model number e.g. NLP65-9612GJ.

- [] Rating with 30 CFM of air
- (1) Optional cover/enclosure
- (2) Optional bracket
- (5) These models feature harmonic current correction to EN61000-3-2
- * Floating output

Output Power		Output				Size W x L x H (mm)	Model	
[Forced Air]	Free Air	V1	V2	V3	V4			
[110 W]	80 W	NFS80 Series						
		5V@15A		24V@2.5A	12V@3A	12V@3A*	4.25" x 7" x 1.8"	NFS80-7602J
		5V@15A		24V@2.5A	15V@3A	15V@3A*	(107.95 x 177.8 x 45.72)	NFS80-7606J
[110 W]	80 W	NLP110 Series						
		5V@22A*				3" x 6.5" x 1.26"	NLP110-9605J ⁽⁵⁾	
		12V@9.2A*				(76.2 x 165.1 x 32)	NLP110-9612J ⁽⁵⁾	
		24V@4.6A*					NLP110-9624J ⁽⁵⁾	
		48V@2.3A*					NLP110-9617J ⁽⁵⁾	
5V@18A		3.3V@20A	12V@1A			NLP110-9693J ⁽⁵⁾		
12V@8.5A		5V@18A	-12V@1A			NLP110-9608J ⁽⁵⁾		
[110 W]	80 W	NFS110 Series						
		12V@9A*				4.25" x 7" x 1.8"	NFS110-7612J	
		24V@4.5A*				(107.95 x 177.8 x 45.72)	NFS110-7624J	
		5.1V@10A	12V@5A	-12V@1A	-5V@1A			NFS110-7601J
		5.1V@10A	12V@5A	-12V@1A	-5V@1A			NFS110-7601PJ
		5.1V@10A	15V@5A	-15V@1A	-5V@1A			NFS110-7604J
		5.1V@10A	15V@5A	-15V@1A	-5V@1A			NFS110-7604PJ
		5V@10A	24V@4A	12V@5A	-12V@1A			NFS110-7602J
		5V@10A	24V@4A	12V@5A	-12V@1A			NFS110-7602PJ
[120 W]	70 W	NTQ120 Series						
		3.3V@14A [25A]	5V@12.5A [24A]	+12V@1A [2A]	-12V@0.5A [1A]	4" x 7" x 1.5"	NTQ123	
		3.3V@14A [25A]	5V@12.5A [24A]	+12V@1A [2A]	-12V@0.5A [1A]	(101.6 x 177.8 x 38.1)	NTQ123-DC	
[130 W]	80 W	LP120 Series						
		3.3V@16A [26A]*				3" x 5" x 1.29"	LPS121	
		5V@16A [26A]*				(101.6 x 177.8 x 38.1)	LPS122	
		12V@6.6A [10.8A]*					LPS123	
		15V@5.3A [8.6A]*					LPS124	
		24V@3.4A [5.4A]*					LPS125	
48V@1.7A [2.7A]*					LPS128			
[130 W]	80 W	LPT100-M Series						
		3.3V@13A [18A]	5V@5A [9A]	12V@1A [2.3A]			2" x 4" x 1.28"	LPT101-M
		5V@13A [18A]	12V@5A [9A]	-12V@1A [2A]			(50.8 x 101.6 x 32.7)	LPT102-M
		5V@13A [18A]	15V@4A [7.2A]	-15V@1A [1.5A]				LPT103-M
		5V@13A [18A]	24V@1.5A [3A]	12V@1A [2.3A]				LPT104-M
[145 W]	80 W	LP140 Series						
		5V@12A [25A] (3.3-5V)	12V@5A [6A]	-12V@1A [1.5A] (-12-15V)	±3.3-25V@1.5A [4.5A]*	4" x 7" x 1.5" (101.6 x 177.8 x 38.1)	LPQ142	

Options:

P Power fail detect option available, please add the suffix "P" to the model;







e.g., NFS110-7601PJ

[] Rating with 30 CFM of air

(1) Optional cover/enclosure

(5) These models feature harmonic current correction to EN61000-3-2

* Floating output

Output Power		Output				Size W x L x H (mm)	Model
[Forced Air]	Free Air	V1	V2	V3	V4		
[150 W]	100 W	TLP150 Series					
		12 V @ 12.5 A*				3" x 5" x 1.25"	TLP150R-96S12J ⁽⁶⁾ F
		24 V @ 6.3 A*				(76.2 x 127 x 31.75)	TLP150R-96S24J ⁽⁶⁾ F
		36 V @ 4.2 A*					TLP150R-96S36J ⁽⁶⁾
		48 V @ 3.2 A*					TLP150R-96S48J ⁽⁶⁾ F
[150 W]	100 W	LPS100-M Series					
		5 V @ 16 A [24 A]*				2" x 4" x 1.29"	LPS102-M
		12 V @ 8.3 A [12.5 A]*				(50.8 x 101.6 x 33)	LPS103-M
		15 V @ 6.7 A [10 A]*					LPS104-M
		24 V @ 4.2 A [6.3 A]*					LPS105-M
		48 V @ 2.1 A [3.1 A]*					LPS108-M
[150 W]	110 W	LP150 Series					
		5 V @ 22 A [30 A]*				4.25" x 8.5" x 1.5" (108 x 215.9 x 38.1)	LPS152
		12 V @ 9.1 A [12.5 A]* (12-15 V)					LPS153
		24 V @ 4.5 A [6.2 A]* (24-28 V)					LPS155
		5 V @ 15 A [22 A]	12 V @ 2.6 A [8 A]	-12 V @ 2 A [2.5 A]	±5-25 V @ 2.5 A [3 A]*		LPQ152
		5 V @ 15 A [22 A]	15 V @ 4.8 A [6.4 A]	-15 V @ 1.6 A [2 A]	±5-25 V @ 2.5 A [3 A]*		LPQ153
		5 V @ 15 A [22 A]	12 V @ 6 A [8 A]	-12 V @ 2 A [2.5 A]	24 V @ 3.5 A [4.5 A]		LPQ154
[165 W]	50 W	NTQ160 Series					
		3.3 V @ 15 A [30 A] (1.8-3.5 V)	5 V @ 10 A [20 A] (3-5.5 V)	12 V @ 2 A [4.5 A]*	12 V @ 2 A [4.5 A]*	4.25" x 8.5" x 1.5" (108 x 215.9 x 38.1)	NTQ162
		5 V @ 15 A [30 A] (3.3-5 V)	3.3 V @ 10 A [20 A]	12 V @ 2 A [4.5 A]*	12 V @ 2 A [4.5 A]*		NTQ163
		3.3 V @ 15 A [30 A] (3.3-5 V)	2.5 V @ 10 A [20 A] (1.8-3.5 V)	5 V @ 2 A [4 A]*	12 V @ 2 A [4 A]*		NTQ165
[175 W]	110 W	LP170 Series					
		5 V @ 22 A [35 A]* (2.5-6 V)				4.25" x 8.5" x 1.5" (108 x 215.9 x 38.1)	LPS172
		12 V @ 9.1 A [15 A]* (6-12 V)					LPS173
		15 V @ 7.3 A [12 A]* (12-24 V)					LPS174
		24 V @ 4.5 A [7.5]* (24-54 V)					LPS175
		5 V @ 15 A [30 A] (3.3-5.5 V)	12 V @ 6 A [8 A]	-12 V @ 0.2 A [3 A] (-12-15 V)	±3.3-25 V @ 2 A [5 A]*		LPQ172
		5 V @ 10 A [24 A] (3.3-5.5 V)	12 V @ 6 A [8 A]	-12 V @ 1.2 A [3 A] (-12-15 V)	5 V @ 10 A [24 A]* (3.3-5 V)		LPQ173
[200 W]	100 W	LPQ200-M Series					
		3.3 V @ 13 A [18 A]	5 V @ 13 A [18 A]	12 V @ 5 A [9 A]	-12 V @ 1 A [2 A]	3" x 5" x 1.32"	LPQ201-M
		5 V @ 13 A [18 A]	12 V @ 5 A [9 A]	24 V @ 1.5 A [3 A]	-12 V @ 1 A [2 A]	(76.2 x 127 x 33.6)	LPQ202-M

Options:

- F Replace the 'J' at the end of the model number with 'FJ' when the optional standby output and / or remote ON/OFF control is required e.g., TLP150N-99S12FJ
- [] Rating with 30 CFM of air
- (1) Optional cover/enclosure

- (5) These models feature harmonic current correction to EN61000-3-2
- * Floating output

Output Power		Output				Size W x L x H (mm)	Model
[Forced Air]	Free Air	V1	V2	V3	V4		
[250 W]	125 W	LPS200-M Series					
	(1)	5 V @ 20 A [40 A]*				3" x 5" x 1.32"	LPS202-M
		12 V @ 10.3 A [20.8 A]*				(76.2 x 127 x 33.6)	LPS203-M
		15 V @ 8.3 A [16.6 A]*					LPS204-M
		24 V @ 5.2 A [10.4 A]*					LPS205-M
		48 V @ 2.6 A [5.2 A]*					LPS208-M
[250 W]	175 W	NLP250 Series					
	(1)	12 V @ 21 A*				4" x 7" x 1.5"	NLP250N-99S12J
		24 V @ 10.5 A*				(101.6 x 177.8 x 38.1)	NLP250N-99S24J
		48 V @ 5.3 A*					NLP250R-96S48J
		NLP250 – DC (-48 Vdc Input)					
		12 V @ 14.6 A [21 A]				4" x 7" x 1.5" (101.6 x 177.8 x 38.1)	NLP250N-48S12J
[250 W]		LP250 Series					
	(3), (4)	5 V (3-6 V) @ [50 A]*				5" x 9" x 2"	LPS252-C
		12 V (6-12 V) @ [21 A]*				(127 x 228.6 x 50.8)	LPS253-C
		15 V (12-24 V) @ [16.7 A]*					LPS254-C
		24 V (24-48 V) @ [10.4 A]*					LPS255-C
		5 V @ [35 A]		12 V @ [10 A]	-12 V @ [6 A]	±5-25 V @ [6 A]*	
5 V @ [35 A]		15 V @ [10 A]	-15 V @ [6 A]	±5-25 V @ [6 A]*		LPQ253-C	
[350 W]		LP350 Series					
	(3), (4)	5 V (3-6 V) @ [70 A]*				5" x 9" x 2.5"	LPS352-C
		12 V (6-12 V) @ [29.2 A]*				(127 x 228.6 x 63.5)	LPS353-C
		15 V (12-24 V) @ [23.3 A]*					LPS354-C
		24 V (24-48 V) @ [14.6 A]*					LPS355-C
		5 V @ [50 A]		12 V @ [12 A]	-12 V @ [6 A]	±3.3-24 V @ [6 A]*	
5 V @ [50 A]		15 V @ [12 A]	-15 V @ [6 A]	±3.3-24 V @ [6 A]*		LPQ353-C	
[350 W]	200 W	NTS350 Series					
	(3), (4)	12 V @ 16.6 A [29.2 A]*				4" x 7" x 1.5"	NTS353
		24 V @ 8.3 A [14.6 A]*				(101.6 x 177.8 x 38)	NTS355
		48 V @ 4.2 A [7.3 A]*					NTS358
		54 V @ 3.7 A [6.5 A]*					NTS359
[500 W]	200 W	NTS500 Series					
	(3), (4)	12 V @ 16.6 A [41.7 A]*				4" x 7" x 1.5"	NTS503
		24 V @ 8.3 A [20.8 A]*				(101.6 x 177.8 x 38)	NTS505
		18 V @ 11.1 A [27.7 A]*					NTS506
		48 V @ 4.2 A [10.4 A]*					NTS508

Options:

[] Rating with 30 CFM of air

(1) Optional cover/enclosure (see datasheet for increased dimensions)

(3) Optional fan cover (see datasheet for increased dimensions)

(4) Optional end fan cover (see datasheet for increased dimensions)

* Floating output

Low Power

External power adapters

2-100 Watts

Special Features

All models feature:

- Wide-range AC input
- High demonstrated MTBF
- Overload protection
- Extensive safety approvals





Many models feature:







- EN61000-3-2 compliance
- Medical approvals
- Thermal protection
- Energy Star

AC Input:

- Wallmount
 - U.S. – 2-prong
 - China – 2-prong
 - Europe – 2-prong
 - United Kingdom – 3-prong
 - Australia – 2-prong
 - Interchangeable
- Freestanding
 - IEC320 2-pin (C14) & (C6)
 - IEC320 2-pin (C8)
- Single output
 - 2.5 mm barrel plug
 - 2.1 mm right angle plug AD7216N2L
- Triple output
 - 5-pin DIN







Output Power	V1	V2	V3	Size W x L x H (mm)	Model
2 W 	DCH2 Series				
	6.5 V @ 0.3 A			1.5" x 1.02" x 1.75"	DCH2-050AU-0001
	6.5 V @ 0.3 A			(38.1 x 26 x 44.4)	DCH2-050EU-0001
	6.5 V @ 0.3 A				DCH2-050UK-0001
	6.5 V @ 0.3 A				DCH2-050US-0001
3 W 	DCH3 Series – USB				
	5 V @ 0.55 A			1.03" x 2.28" x 1.81" (26.1 x 58 x 46)	DCH3-050US-0001 DCH3-050US-0002
	5 V @ 0.55 A			1.03" x 2.28" x 1.80" (26.1 x 58 x 45.8)	DCH3-050EU-0001 DCH3-050EU-0002
	5 V @ 0.55 A			2.02" x 2.28" x 0.91" (51.2 x 57.8 x 23)	DCH3-050UK-0001 DCH3-050UK-0002
	5 V @ 0.55 A			1.07" x 2.66" x 1.81" (27.2 x 67.2 x 46)	DCH3-050US-0004
	5 V @ 0.55 A			1.07" x 2.66" x 1.81" (27.2 x 67.2 x 46)	DCH3-050EU-0004
	5 V @ 0.55 A			2.02" x 2.64" x 0.97" (51.2 x 67 x 24.5)	DCH3-050UK-0004
	5 V @ 0.55 A			1.67" x 2.63" x 1.05" (42.4 x 66.8 x 26.7)	DCH3-050AU-0004
4 W 	DA4 Series				
	5.5 V @ 0.75 A			1.02" x 2.36" x 1.80" (26 x 60 x 45.8)	DA4-050US
	5.5 V @ 0.75 A			1.02" x 2.36" x 2.23" (26 x 60 x 58.3)	DA4-050EU
	5.5 V @ 0.75 A			1.02" x 2.36" x 1.80" (26 x 60 x 45.8)	DA4-050CH
8 W 	DA4 US Series				
	11 V @ 0.30 A			1.02" x 2.36" x 1.80"	DA4-110US
	16.5 V @ 0.30 A			(26 x 60 x 45.8)	DA4-165US
	18 V @ 0.30 A				DA4-180US
	21.5 V @ 0.30 A				DA4-215US
	23 V @ 0.30 A			1.10" x 2.36" x 1.99"	DA4-230US
26.5 V @ 0.30 A			(28 x 60 x 50.6)	DA4-265US	

Output Power	V1	V2	V3	Size W x L x H (mm)	Model
12 W 	DA12-M Series				
	5V@2A			1.10" x 2.36" x 2.14" (28 x 60 x 54.3)	DA12-050AU-M
	12V@1A				DA12-120AU-M
	5V@2A			1.10" x 2.36" x 2.48" (28 x 60 x 63.1)	DA12-050EU-M
	12V@1A				DA12-120EU-M
	5V@2A			1.98" x 2.36" x 1.90" (50.2 x 60 x 48.3)	DA12-050UK-M
	12V@1A				DA12-120UK-M
	5V@2A			1.10" x 2.36" x 1.99" (28 x 60 x 50.6)	DA12-050US-M
	12V@1A				DA12-120US-M
	12V@1A			1.10" x 2.36" x 2.14" (28 x 60 x 54.3)	DA12-120MP-M ⁽¹⁾
16 W 	DA16 Series				
	12V@1.33A			2.08" x 3.03" x 1.17" (53.0 x 77.0 x 29.8)	DA16-120US
	12V@1.33A				DA16-120EU
	12V@1.33A				DA16-120UK
12V@1.33A				DA16-120AU	
24 W 	AD24				
12V@2A			1.89" x 4.13" x 1.3" (48 x 105 x 33)	AD2412N3L	
40 W 	DP40 Series				
	9V@4.4A			2.4" x 4.88" x 1.55" (61 x 124 x 39.5)	DP4009N2M
	9V@4.4A				DP4009N3M
	12V@3.33A				DP4012N2M
	12V@3.33A				DP4012N3M
	15V@2.67A				DP4015N2M
	15V@2.67A				DP4015N3M
	18V@2.22A				DP4018N2M
	18V@2.22A				DP4018N3M
	24V@1.67A				DP4024N2M
24V@1.67A				DP4024N3M	
48V@0.84A				DP4048N2M	
48V@0.84A				DP4048N3M	
50 W 	AD50 Series				
	12V@4.16A			2.56" x 4.72" x 1.61" (65 x 120 x 41)	AD5012N2L
12V@4.16A				AD5012N3L	
50 W 	DPT50 Series				
	3.3V@9A	5V@3A	-12V@0.5A	2.39" x 5.24" x 1.62" (60.7 x 133 x 41.15)	DPT51
	5V@8A	12V@3A	-12V@0.5A		DPT52
	5V@8A	15V@2.4A	-15V@0.5A		DPT53
5V@8A	24V@1.5A	12V@0.5A		DPT54	

Options:

(1) Interchangeable AC plug - must be purchased separately.

Output Power	V1	V2	V3	Size W x L x H (mm)	Model
60 W 	DPS50 Series				
	5 V@6 A			2.39" x 5.24" x 1.62"	DPS52
	12 V@5 A			(60.7 x 133 x 41.15)	DPS53
	15 V@4 A				DPS54
	24 V@2.5 A				DPS55
	48 V@1.25 A				DPS58
72 W 	AD72				
	16 V@4.5 A			2.0" x 4.54" x 1.10" (51 x 115.4 x 28)	AD7216N2L
78 W 	AD80				
	24 V@3.25 A			3.13" x 5.87" x 1.76" (79.6 x 149 x 44)	AD8024N3L-001
100 W 	AD100				
	48 V@2.08 A			2.56" x 3.03" x 1.44" (65 x 156 x 37.2)	AD10048P3L-001



Healthcare AC–DC Power Supplies

Up to 4860 Watts

Emerson Network Power produces a wide range of AC–DC power supplies certified for use in medical equipment requiring lower safety ground leakage and higher isolation. The power supplies listed below are designed for use in non-patient critical applications: bio-life science, medical, dental, imaging and laboratory applications such as immunoassay and in-vitro diagnostics machines, ultrasound and mass analyzers. All these power supplies are high efficiency switch-mode designs, and feature full medical safety approval to EN60601-1.



Special Features

All models feature:

- Industry standard footprints
- Wide-range AC input
- Remote sense
- Adjustable outputs
- Power fail
- Full power to 50 °C
- High demonstrated MTBF
- Overvoltage protection
- Overload protection
- Built-in EMI filtering
- Medical approvals
- Extensive safety approvals
- Derated operation to 70 °C

Many models feature:

- EN61000-3-2 compliance
- Supervisory outputs (5 V/12 V)
- Wide-adjust floating 4th output
- Single wire current share
- Wide-adjust on single output models







Output Power		Output				Size W x L x H (mm)	Model
[Forced Air]	Free Air	V1	V2	V3	V4		
[50 W]	40 W	NFS40 Series – Medical					
		12 V@4 A*				3" x 5" x 1.2"	NFS40-7912J
		15 V@3.3 A*				(76.2 x 127 x 30.5)	NFS40-7915J
		24 V@2 A*					NFS40-7924J
		5.1 V@7 A	12 V@1 A	-12 V@1 A			NFS40-7928J
		5.1 V@5 A	12 V@2 A	-12 V@0.5 A			NFS40-7908J
		5.1 V@5 A	15 V@2 A	-15 V@0.5 A			NFS40-7910J
[55 W]	40 W	LP40-M Series – Medical					
		5 V@8 A [11 A]*				3" x 5" x 1.2"	LPS42-M
		12 V@3.3 A [4.5]*				(76.2 x 127 x 30.5)	LPS43-M
		15 V@2.6 A [3.6 A]*					LPS44-M
		24 V@1.6 A [2.3 A]*					LPS45-M
		5 V@4 A [5 A]	12 V@2 A [2.5 A]	-12 V@0.5 A [0.7 A]			LPT42-M
		5 V@4 A [5 A]	15 V@2 A [2.5 A]	-15 V@0.5 A [0.7 A]			LPT45-M
[60 W]	45 W	NPS40-M Series – Medical					
		5 V@8 A [11 A]				2" x 4" x 1"	NPS42-M
		12 V@3.75 A [5 A]				(50.8 x 101.6 x 25.4)	NPS43-M
		15 V@3 A [4 A]					NPS44-M
		24 V@1.9 A [2.5 A]					NPS45-M
		48 V@0.94 A [1.25 A]					NPS48-M
[55 W]	55 W	LP50-M Series – Medical					
		3.3 V@8 A	5 V@3 A	12 V@0.5 A		2" x 4" x 1.3"	LPT51-M
		5 V@8 A	12 V@3 A	-12 V@0.5 A		(50.8 x 101.6 x 33)	LPT52-M
		5 V@8 A	15 V@2.4 A	-15 V@0.5 A			LPT53-M
		5 V@8 A	24 V@1.5 A	12 V@0.5 A			LPT54-M
[60 W]	60 W	LPS50-M Series – Medical					
		5 V@11 A*					LPS52-M
		12 V@5 A*					LPS53-M
		15 V@4 A*					LPS54-M
		24 V@2.5 A*					LPS55-M
		48 V@1.25 A*					LPS58-M

Options:

[] Rating with 30 CFM of air

(1) Optional cover/enclosure

* Floating output

Output Power		Output				Size W x L x H (mm)	Model
[Forced Air]	Free Air	V1	V2	V3	V4		
[75 W]	65 W	NLP65 Series – Medical					
		12 V @ 6.5 A*				3" x 5" x 1.26"	NLP65-9912J ⁽⁵⁾
		15 V @ 5.3 A*				(76.2 x 27 x 32)	NLP65-9915J ⁽⁵⁾
		24 V @ 3.5 A*					NLP65-9924J ⁽⁵⁾
		5 V @ 8 A	12 V @ 3 A				NLP65-9929J ⁽⁵⁾
		5 V @ 8 A	24 V @ 2 A				NLP65-9920J ⁽⁵⁾
		5 V @ 8 A	12 V @ 3 A	-12 V @ 1 A			NLP65-9908J ⁽⁵⁾
[80W]	60 W	LP60-M Series – Medical					
(1) 		12 V @ 5 A [6.7 A]*				3" x 5" x 1.65"	LPS63-M
		15 V @ 4 A [5.3 A]*				(76.2 x 127 x 41.9)	LPS64-M
		24 V @ 2.5 A [3.3 A]*					LPS65-M
		5 V @ 7 A [8 A]	12 V @ 3 A [3.5 A]	-12 V @ 0.7 A [1 A]			LPT62-M
		5 V @ 7 A [8 A]	15 V @ 2.8 A [3.3 A]	-15 V @ 0.7 A [1 A]			LPT63-M
[110 W]	80 W	NLP110 Series – Medical					
		5 V @ 22 A*				3" x 6.5" x 1.26"	NLP110-9905J ⁽⁵⁾
		12 V @ 9.2 A*				(76.2 x 165.1 x 45.72)	NLP110-9912J ⁽⁵⁾
		24 V @ 4.6 A*					NLP110-9924J ⁽⁵⁾
		48 V @ 2.3 A*					NLP110-9917J ⁽⁵⁾
		3.3 V @ 20 A	2.5 V @ 20 A	12 V @ 1 A			NLP110-9994J ⁽⁵⁾
		5 V @ 18 A	3.3 V @ 20 A	12 V @ 1 A			NLP110-9993J ⁽⁵⁾
		12 V @ 8.5 A	3.3 V @ 20 A	-12 V @ 1 A			NLP110-9995J ⁽⁵⁾
		12 V @ 8.5 A	5 V @ 18 A	-12 V @ 1 A			NLP110-9908J ⁽⁵⁾
[110 W]	80 W	NFS110 Series – Medical					
(1) 		12 V @ 9 A*				4.25" x 7" x 1.8"	NFS110-7912J
		15 V @ 7.3 A*				(107.95 x 177.8 x 32)	NFS110-7915J
		24 V @ 4.5 A*					NFS110-7924J
		5.1 V @ 10 A	24 V @ 5 A	-12 V @ 1 A	-5 V @ 1 A		NFS110-7901PJ
		5 V @ 10 A	24 V @ 4 A	12 V @ 5 A	-12 V @ 1 A		NFS110-7902PJ
[130 W]	80 W	LPT100-M Series – Medical					
(1) 		3.3 V @ 13 A [18 A]	5 V @ 5 A [9 A]	12 V @ 1 A [2.3 A]		2" x 4" x 1.28"	LPT101-M
		5 V @ 13 A [18 A]	12 V @ 5 A [9 A]	-12 V @ 1 A [2 A]		(50.8 x 101.6 x 32.7)	LPT102-M
		5 V @ 13 A [18 A]	15 V @ 4 A [7.2 A]	-15 V @ 1 A [1.5 A]			LPT103-M
		5 V @ 13 A [18 A]	24 V @ 1.5 A [3 A]	12 V @ 1 A [2.3 A]			LPT104-M
[150 W]	100 W	LPS100-M Series – Medical					
(1) 		5 V @ 16 A [24 A]*				2" x 4" x 1.29"	LPS102-M
		12 V @ 8.3 A [12.5 A]*				(50.8 x 101.6 x 33)	LPS103-M
		15 V @ 6.7 A [10 A]*					LPS104-M
		24 V @ 4.2 A [6.3 A]*					LPS105-M
		48 V @ 2.1 A [3.1 A]*					LPS108-M
[150 W]	100 W	TLP150 Series – Medical					
(1) 		12 V @ 12.5 A*				3" x 5" x 1.25"	TLP150N-99S12J ⁽⁵⁾ F
		24 V @ 6.3 A*				(177.8 x 101.6 x 31.75)	TLP150N-99S24J ⁽⁵⁾ F

Options:

F Replace the 'J' at the end of the model number with 'FJ' when the optional standby output and/or remote ON/OFF control is required e.g., TLP150N-99S12FJ
 [] Rating with 30 CFM of air

(1) Optional cover/enclosure (see datasheet for increased dimensions)
 (5) These models feature harmonic current correction to EN61000-3-2
 * Floating output

Output Power		Output				Size W x L x H (mm)	Model
[Forced Air]	Free Air	V1	V2	V3	V4		
[175 W]	110 W	LP170-M Series – Medical					
		5 V @ 22 A [35 A]* (2.5-6 V)				4.25" x 8.5" x 1.5" (108 x 215.9 x 38.1)	LPS172-M
		12 V @ 9.1 A [15 A]* (6-12 V)					LPS173-M
		15 V @ 7.3 A [12 A]* (12-24 V)					LPS174-M
		24 V @ 4.5 A [7.5]* (24-54 V)					LPS175-M

[200 W]	100 W	LPQ200-M Series – Medical					
	(1)	3.3 V @ 13 A [18 A]	5 V @ 13 A [18 A]	12 V @ 5 A [9 A]	-12 V @ 1 A [2 A]	3" x 5" x 1.32"	LPQ201-M
		5 V @ 13 A [18 A]	12 V @ 5 A [9 A]	24 V @ 1.5 A [3 A]	-12 V @ 1 A [2 A]	(76.2 x 127 x 33.6)	LPQ202-M

[250 W]	125 W	LPS200-M Series – Medical					
	(1)	5 V @ 20 A [40 A]*				3" x 5" x 1.32"	LPS202-M
		12 V @ 10.3 A [20.8 A]*				(76.2 x 127 x 33.6)	LPS203-M
		15 V @ 8.3 A [16.6 A]*					LPS204-M
		24 V @ 5.2 A [10.4 A]*					LPS205-M
		48 V @ 2.6 A [5.2 A]*					LPS208-M

[250 W]	175 W	NLP250 Series – Medical					
	(1)	12 V @ 21 A*				4 x 7 x 1.5	NLP250N-99S12J
		24 V @ 10.5 A*				(101.6 x 177.8 x 38.1)	NLP250N-99S24J

[500 W]	200 W	NTS500-M Series – Medical					
	(4), (5)	12 V @ 16.6 A [41.7 A]*				4" x 7" x 1.5"	NTS503-M
		24 V @ 8.3 A [20.8 A]*				(101.6 x 177.8 x 38)	NTS505-M
		48 V @ 4.2 A [10.4 A]*					NTS508-M

Output Power		Output			Size H x W x L (mm)	Model
Up to 1500 W		2-60 V	1-21 outputs	Fully configurable and intelligent		
		iMP Medium Power Series			2.5" x 5" x 10" (63.5 x 127 x 254)	iMP4, iMP8 See iMP section

1500-4920 W		iVS High Power Series				
		2-60 V	1-21 outputs	Fully configurable and intelligent	5" x 5" x 11" (63.5 x 127 x 279.4)	iVS1, iVS6
					5" x 8" x 11" (63.5 x 203.2 x 279.4)	iVS3, iVS8 See iVS section

Options:

(1) Optional enclosure

(4) Optional fan covers (see datasheet for increased dimensions)

* Floating output

(5) Optional end fan cover (see datasheet for increased dimensions)

Output Power	V1	V2	V3	Size W x L x H (mm)	Model
12 W 	DA12-M Series – Medical				
	5 V @ 2 A			1.10" x 2.36" x 2.14" (28 x 60 x 54.3)	DA12-050AU-M
	12 V @ 1 A				DA12-120AU-M
	5 V @ 2 A			1.10" x 2.36" x 2.48" (28 x 60 x 63.1)	DA12-050EU-M
	12 V @ 1 A				DA12-120EU-M
	5 V @ 2 A			1.98" x 2.36" x 1.90" (50.2 x 60 x 48.3)	DA12-050UK-M
	12 V @ 1 A				DA12-120UK-M
	5 V @ 2 A			1.10" x 2.36" x 1.99" (28 x 60 x 50.6)	DA12-050US-M
	12 V @ 1 A				DA12-120US-M
	12 V @ 1 A			1.10" x 2.36" x 2.14" (28 x 60 x 54.3)	DA12-120MP-M ⁽¹⁾
24 W 	DP40 Series – Medical				
	9 V @ 4.4 A			2.4" x 4.88" x 1.55" (61 x 124 x 39.5)	DP4009N2M
	9 V @ 4.4 A				DP4009N3M
	12 V @ 3.33 A				DP4012N2M
	12 V @ 3.33 A				DP4012N3M
	15 V @ 2.67 A				DP4015N2M
	15 V @ 2.67 A				DP4015N3M
	18 V @ 2.22 A				DP4018N2M
	18 V @ 2.22 A				DP4018N3M
	24 V @ 1.67 A				DP4024N2M
	24 V @ 1.67 A				DP4024N3M
	48 V @ 0.84 A				DP4048N2M
	48 V @ 0.84 A				DP4048N3M
50 W 	AD50-M Series – Medical				
	12 V @ 4.16 A			2.56" x 4.72" x 1.61" (65 x 120 x 41)	AD5012N2LM
	12 V @ 4.16 A				AD5012N3LM
50 W 	DPT50-M Series – Medical				
	3.3 V @ 9 A	5 V @ 3 A	-12 V @ 0.5 A	2.39" x 5.24" x 1.62" (60.7 x 133 x 41.15)	DPT51-M
	5 V @ 8 A	12 V @ 3 A	-12 V @ 0.5 A		DPT52-M
	5 V @ 8 A	15 V @ 2.4 A	-15 V @ 0.5 A		DPT53-M
	5 V @ 8 A	24 V @ 1.5 A	12 V @ 0.5 A		DPT54-M
60 W 	DPS50-M Series – Medical				
	5 V @ 6 A			2.39" x 5.24" x 1.62" (60.7 x 133 x 41.15)	DPS52-M
	12 V @ 5 A				DPS53-M
	15 V @ 4 A				DPS54-M
	24 V @ 2.5 A				DPS55-M
	48 V @ 1.25 A				DPS58-M

Options:

(1) Interchangeable AC plug - must be purchased separately.

MP Series

Modular power supply for optimum flexibility

Up to 1200 Watts

Total Power: Up to 1200 W
 Input Voltage: 85-264 Vac
 120-350 Vdc
 # of Outputs: Up to 21



Special Features

- Low cost
- Current share on all outputs with ratings of 10 A or greater
- Remote sense on all outputs with ratings greater than 2 A
- Overload protection on all outputs
- Voltage adjustment on all outputs
- Margining on all single output modules
- Input OK signal and status indicator LED
- Global DC OK signal and status indicator LED
- Global and individual module inhibits/enable
- Forced air cooling or customer provided air option
- Isolated 1 A 5 V bias voltage
- Power factor correction
- EN61000-3-2 harmonic distortion compliance
- CISPR 22, EN55022 Curve B conducted/ radiated EMI
- European CE Mark requirements
- Optional VME timing and system DC OK module
- Low leakage option
- EN61000 immunity standards
- Standard modification flexibility (see datasheet on Emerson.com/EmbeddedPower)

New Options Now Available

- Optional battery charger module
- Optional 2 A 5 V bias voltage
- Optional extended hold-up module
- Optional high voltage module (non-isolated)
- Optional OR'ing diode module



Electrical Specifications

Input	
Input voltage	85-264 Vac 120-350 Vdc
Frequency	47-440 Hz
Inrush current	40 A peak maximum (soft start)
Efficiency	70-80% typ. @ full case load
Power factor	0.99 typ. meets EN61000-3-2 (N/A @ 440 Hz)
Turn-on time	AC on 1.5 second typical Inhibit/enable 150 ms typical
EMI filter standard	CISPR 22 EN55022 Level "B"
EMI filter (low leakage option)	CISPR 22 EN55022 Level "A"
Leakage current standard	2.0 mA maximum @ 240 Vac
Leakage current (low leakage option)	300 µA maximum @ 240 Vac
Radiated EMI	CISPR 22 EN55022 Level "B"
Holdover storage	20 ms minimum (independent of input Vac)
AC OK	>5 ms early warning minimum before outputs lose regulation Full cycle ride thru (50 Hz)
Harmonic distortion	Meets EN61000-3-2
Isolation	Meets EN60950
Global inhibit/enable	TTL, Logic "1" and Logic "0"; configurable
Input fuse (internal)	MP4: 10 A; MP6: 15 A; MP8: 20 A; MP1: 20 A
Warranty	Two years

Output	
Adjustment range	±10% minimum all outputs
Margining	±4-6% nominal ¹
Overall regulation	0.4% or 20 mV maximum (36 W modules 4% maximum)
Ripple	RMS: 0.1% or 10 mV, whichever is greater; Pk-Pk: 1.0% or 50 mV, whichever is greater; bandwidth limited to 20 MHz
Dynamic response	<2% or 100 mV, with 25% load step
Recovery time	To within 1% in <300 μ second
Overcurrent protection	Single, main of dual output module 105-120% of rated output current
Short-circuit protection	Protected for continuous short-circuit Recovery is automatic upon removal of short
Overvoltage protection (measured at sense connection)	Single output modules
Reverse voltage protection	100% of rated output current
Thermal protection	All outputs disabled when internal temp exceeds safe operating range. > 5 ms warning (AC OK signal) before shutdown
Remote sense	Up to 0.5 V total drop (not available on triple output module)
Single wire parallel	Current share to within 2% of total rated current ²
DC OK	-2% to -8% of nominal for any monitored output ²
Minimum load	Not required on single or triple output modules. 10% required on main of dual output modules ³
Housekeeping standby	5 Vdc @1.0 A mA maximum present whenever AC input is applied (optional 2.0 A available)
Module inhibit	TTL, isolated, singles and dual (both outputs) only
Switching frequency	250 kHz
Output/output isolation	>1 Megohm
VME signal option board	POR signal & quad external DC OK

Environmental Specifications

Operating temperature	-20 °C to 50 °C (start @ 0 °C) (derate each output linearly to 50% at 70 °C) (-20 °C to 40 °C max. with rear air option)
Storage/vibration	MIL-HDBK 810E
Humidity	95% non-condensing
Storage temperature	-40 °C to 85 °C
Temperature coefficient	0.02% per °C
Cooling:	Internal DC fan or customer provided air (option)

Safety

UL	UL1950
CSA	CSA22.2 No. 234 Level 5
IEC	IEC950, Class 1
VDE	EN60950-1
BABT	Compliance to EN 60950, BS 7002
CB	Certificate and report
CE	Mark

Notes:

1. Single output modules only
2. Single and main of dual output modules only
3. Contact factory for optional preload if required

Ordering Information

Sample below is 1200 W case with 12 V @ 50 A; 5 V @ 60 A; 24 V @ 8.5 A; 12 V @ 10 A; 12 V @ 4 A; extended hold-up with no options.

Case Size	Module/Voltage(s) First - Module Code Second - Voltage Code	Add-on Modules Requires 1 slot each	Case Option Codes	Hardware Code
MP1	3L - 2E - 1Q - 4LL	HUP	00	###
Case Size (mm) 4 = 2.5" x 5" x 10"; 400-600 W, 5 Slots (63.5 x 127 x 254) 6 = 2.5" x 5" x 11"; 600-800 W, 5 Slots (63.5 x 127 x 279.4) 8 = 2.5" x 7" x 10"; 800-1000 W, 6 Slots (63.5 x 177.8 x 254) 1 = 2.5" x 8" x 11"; 1000-1200 W, 7 Slots (63.5 x 203.2 x 279.4)	Module Codes Module/Voltage/Option Codes Module Codes: (None) = 36 W Triple O/P (1 slot) 1 = 210 W Single O/P (1 slot) 2 = 360 W Single O/P (2 slot) 3 = 750 W Single O/P (3 slot) 4 = 144 W Dual O/P (1 slot) 5 - 9 = Future Voltage Codes: See Output Module Voltage/ Current table	Add-on Modules HUP = Hold up module VME = VME POR signal and isolated DC	Case Option Codes First Digit 0 - 9 = parallel code (See MP parallel codes table on following page) Second Digit Standard Options 0 = no options 1 = rear air exhaust 3 = global enable 5 = option package (options 1 & 3) M = low leakage N = low leakage plus option 1 P = low leakage plus option 3 R = low leakage plus option 5	Factory assigned for modifications

Case Specifications

MP4 and MP6 (AC input on opposite side)

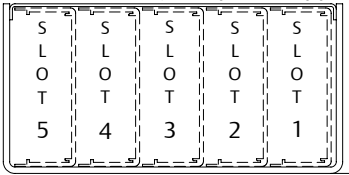

MP4 = 2.5" x 5" x 10" (63.5 x 127 x 254 mm)
5 available slots

MP6 = 2.5" x 5" x 11" (63.5 x 127 x 279.4 mm)
5 available slots

Input
85-264 Vac 400 W max.
180-264 Vac 600 W max.

MP8 and MP1

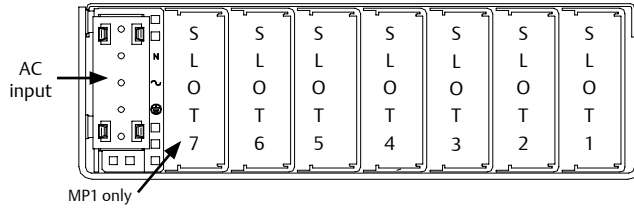

MP8 = 2.5" x 7" x 10" (63.5 x 177.8 x 254 mm)
6 available slots

MP1 = 2.5" x 8" x 11" (63.5 x 203.2 x 279.4 mm)
7 available slots

Input
85-264 Vac 800 W max.
180-264 Vac 1000 W max.

MP8 = 2.5" x 7" x 10" (63.5 x 177.8 x 254 mm)
6 available slots

MP1 = 2.5" x 8" x 11" (63.5 x 203.2 x 279.4 mm)
7 available slots

MP Module Specifications

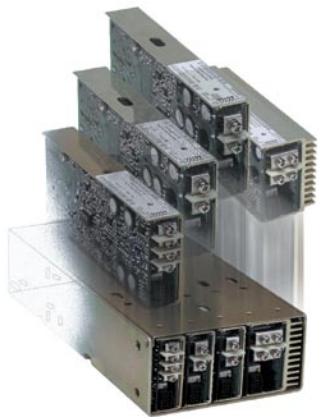

	Output				
	Single 1	Single 2	Single 3	Dual 4	Triple
Module code	1	2	3	4	
Max output power	210 W	360 W	600 W	144 W	36 W
Max output current	35 A	60 A	120 A	10 A	2 A
Output voltages available	2-60 V	2-60 V	2-60 V	2-28 V	2-28 V
Standard voltage increments	25	25	25	19	18
Remote sense on outputs	Yes	Yes	Yes	Yes, both	No
Remote margin/V-Program	Yes	Yes	Yes	No	No
Module inhibit (isolated)	Yes	Yes	Yes	No	No
Single wire active current share	Yes	Yes	Yes	Yes, main only	No
Overshoot/overcurrent protection	Yes	Yes	Yes	Yes	OCP only
Minimum load required	No	No	No	10% main only	No
Slots occupied in any MP case	1	2	3	1	1

Designers' tip:

For assistance in configuring your specific requirement, contact Technical Support.
+1 888 412 7832 (North America)
or +1 407 241 2752
0 800 0321546 (in the UK)
+44 800 0321546 (outside the UK)
Email:
techsupport.embeddedpower@emerson.com

Voltage	Voltage Code	Single Output Module Code			Dual Output**		Triple Output		
		1	2	3	V1	V2	V1	V2	V3
2 V	A	35 A	60 A	120 A	—	10 A	—	—	2 A
2.2 V	B	35 A	60 A	120 A	—	10 A	—	—	2 A
3 V	C	35 A	60 A	120 A	—	10 A	—	—	2 A
3.3 V	D	35 A	60 A	120 A	—	10 A	—	—	2 A
5 V	E	35 A	60 A	120 A	10 A	10 A	—	—	2 A
5.2 V	F	35 A	60 A	115 A	—	10 A	—	—	2 A
5.5 V	G	34 A	58 A	109 A	—	10 A	—	—	2 A
6 V	H	23 A	42 A	78 A	—	10 A	—	—	2 A
8 V	I	20 A	36 A	68 A	—	—	1 A	1 A	1 A
10 V	J	18 A	32 A	60 A	—	—	1 A	1 A	1 A
11 V	K	17 A	31 A	54.5 A	—	—	1 A	1 A	1 A
12 V	L	17 A	30 A	50 A	10 A	4 A	1 A	1 A	1 A
14 V	M	14 A	21 A	40.5 A	9 A	4 A	1 A	1 A	1 A
15 V	N	14 A	20 A	39 A	8 A	4 A	1 A	1 A	1 A
18 V	O	11 A	19 A	33.3 A	—	—	—	0.5 A	0.5 A
20 V	P	10.5 A	18 A	30 A	—	—	—	0.5 A	0.5 A
24 V	Q	8.5 A	15 A	23.5 A	4 A	2 A	—	0.5 A	0.5 A
28 V	R	6.7 A	12.8 A	21.4 A	3 A	2 A	—	0.5 A	0.5 A
30 V	S	6.5 A	12 A	20 A	—	—	—	—	—
33 V	T	6.2 A	10.9 A	18.2 A	—	—	—	—	—
36 V	U	5.8 A	10 A	16.6 A	—	—	—	—	—
42 V	V	4.2 A	7.5 A	12.5 A	—	—	—	—	—
48 V	W	4 A	7.5 A	12.5 A	—	—	—	—	—
54 V	X	3.7 A	6 A	11 A	—	—	—	—	—
60 V	Y	3.5 A	6 A	10 A	—	—	—	—	—
Non-std*	Z	Special Voltage - Consult factory for specifications							

Parallel Codes

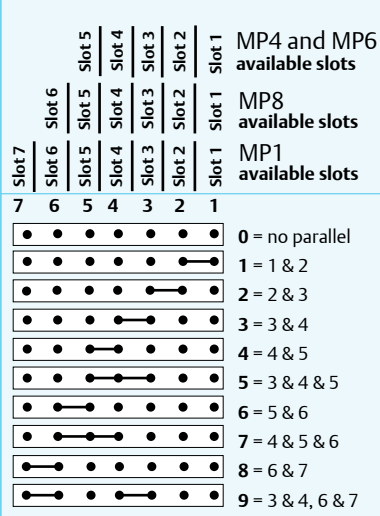

* Note: Increments of current not shown can be achieved by paralleling modules (add currents of each module selected)
** Total loading of outputs on the dual module not to exceed 144 W.

Intelligent MP Series

Intelligent modular power supply for optimum flexibility

Up to 1500 Watts

Total Power: Up to 1500 Watts
 Input Voltage: 85-264 Vac
 120-300 Vdc
 # of Outputs: Up to 21

iMP™

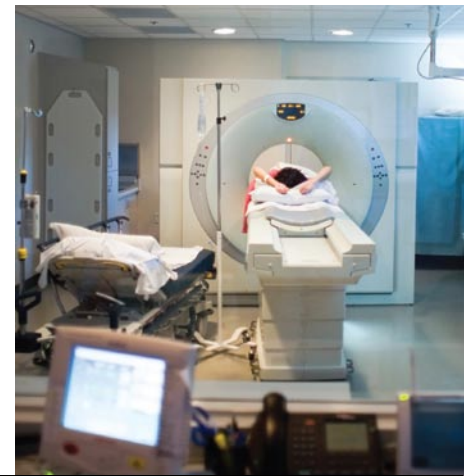
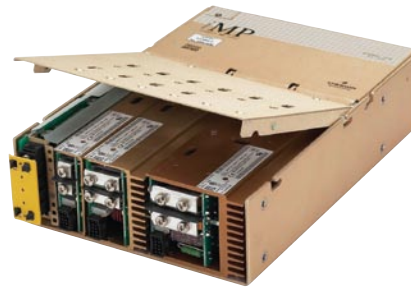

Special Features

- Full Medical EN60601 approval
- Intelligent I²C control
- Voltage adjustment on all outputs (Manual or I²C)
- Configurable input and output (case and module) OK signals and indicators
- Configurable inhibit/enable
- Configurable output UP/DOWN sequencing
- Configurable current limit (foldback or constant current)
- High power density (8.8 W/cu-in)
- Intelligent fan (speed control/fault status)
- Downloadable GUI from website
- Customer provided air option
- μ P controlled PFC input with active inrush protection
- I²C monitor of voltage, current, and temp
- Programmable voltage, current limit, inhibit/enable through I²C
- Optional extended hold-up module (SEMI F47 compliance)
- CAN BUS and RS-485 interface option
- Increased power density to 50% over standard MP
- Backward compatibility with standard MP
- External switching frequency sync input
- Optional conformal coating
- Industrial temp range (-40 °C to 70 °C)
- No preload required
- Industrial shock/vibration (>50 Gs)

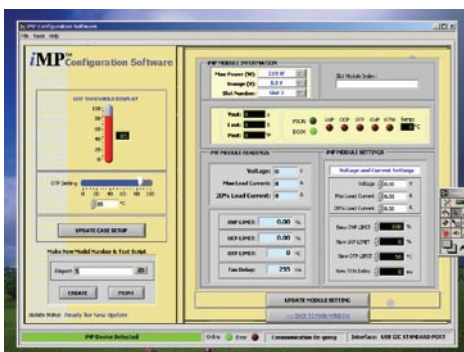

The iMP software is designed to make the iMP Power Supply Unit (PSU) accessible to the user. It is intended to provide information gathered from the PSU and interactive controls to the basic capabilities of iMP power supply. To download go to: Emerson.com/iMP

Electrical Specifications

Input	
Input range	85-264 Vac 120-350 Vdc (limited to 300 Vdc in medical applications)
Frequency	47-440 Hz
Inrush current	40 A peak max. (soft start)
Efficiency	Up to 85% @ full case load
Power factor	0.99 typ. meets EN61000-3-2 (n/a @ 440 Hz)
Turn-on time	AC on 1.5 sec typ., inhibit/enable 150 ms typical programmable delay
EMI filter	CISPR 22/EN55022 Level "B"
Leakage current	300 μ A max. @ 240 Vac; 47-63 Hz
Radiated EMI	CISPR 22/EN55022 Level "B"
Holdover storage	20 ms minimum (independent of input Vac) additional 34 ms holdover storage with optional HUP module (SEMI F47 compatible)
AC OK	>5 ms early warning min. before outputs lose regulation Full cycle ride thru (50 Hz) (N/A on iMP4>750 W @ 90 Vac)
Harmonic distortion	Meets EN61000-3-2
Isolation	Meets EN60950 and EN60601
Global Inhibit/Enable	TTL, Logic "1" and Logic "0"; configurable
Input fuse (internal)	iMP4: 16 A; iMP8: 20 A; iMP1: 25 A (both lines fused)
Warranty	Two years

Output	
Adjustment range*	±10% minimum all outputs (manual) (full module adjustment range using I ² C)
Margining	±4-6% nominal analog (single output module only)
Overall regulation	0.4% or 20 mV max. (36 W modules 4% maximum)
Ripple	RMS: 0.1% or 10 mV, whichever is greater Pk-Pk: 1.0% or 50 mV, whichever is greater Bandwidth limited to 20 MHz
Dynamic response	<2% or 100 mV, with 25% load step
Recovery time	To within 1% in <300 μsec
Overcurrent protection**	Configurable through I ² C (calibration required). Single output module and main output of the dual output module 105-120% of rated output current. Aux output of dual output module 105-140% of rated output current
Short-circuit protection	Protected for continuous short-circuit Recovery is automatic upon removal of short
Overvoltage protection*	Configurable through I ² C - Single output module 2-5.5 V 122-134%; 6-60 V 110-120% - Dual output module 2-6 V 122-134%; 8-28 V 110-120% - Triple output module No overvoltage protection provided
Reverse voltage protection	100% of rated output current
Thermal protection* (OTP and OTW)	Configurable through I ² C All outputs disabled when internal temp exceeds safe operating range. > 5 ms warning (AC OK signal) before shutdown
Remote sense	Up to 0.5 V total drop (not available on triple output module)
Single wire parallel	Configurable through firmware Current share to within 2% of total rated current
DC OK*	±5% of nominal. Configurable through I ² C
Minimum load	Not required
Housekeeping standby	5 Vdc @ 1.0 A max. present whenever AC input is applied (Optional 2.0 A available)
Module inhibit*	Configured and controlled through I ² C
Switching frequency	250 kHz accepts external sync signal
Output/Output isolation	>1 Megohm, 500 V

* Can be controlled via I²C
** Controlled via I²C but requires load calibration

Environmental Specifications

Operating temperature	-40 ° to 70 °C ambient. Derate each output 2.5% per degree from 50 ° to 70 °C. (-20 °C start up)
Storage temperature	-40 °C to 85 °C
Electromagnetic susceptibility	Designed to meet EN61000-4; -2, -3, -4, -5, -6, -8, -11 Level 3
Humidity	Operating; non-condensing 10% to 95% RH
Vibration	IEC68-2-6 to the levels of IEC721-3-2
MTBF demonstrated	>550,000 hours at full load, 220 Vac and 25 °C ambient conditions

Safety

UL	UL60950/UL2601 (through CSA)
CSA	CSA22.2 No. 234 Level 5
VDE	EN60950-1
BABT	Compliance to EN60950/ EN60601 BS7002
CB	Certificate and report
CE	Mark to LVD

Output Module Line-up

Module Code	1	2	3	4	5
Module Type	Single	Single	Single	Dual	Triple
Max output power	210 W	360 W	750 W	144 W	36 W
Max output current	35 A	60 A	150 A	10 A	2 A
Output voltages available*	2-60 V	2-60 V	2-60 V	6-15, 24-28; 6-15, 6-15; 6-15, 2-6; 2-6, 2-6; 24-28, 24-28; 24-28; 2-6	8-15, 8-15, 2-6; 8-15, 8-15, 8-15, 8-15, 18-28; 8-15, 18-28, 2-6
Standard voltage increments	25	25	25	16	18
Remote sense	Yes	Yes	Yes	Yes	No
Remote margin	Yes	Yes	Yes	No	No
V-Program - I ² C control	Yes	Yes	Yes	Yes	No
Active current share	Yes	Yes	Yes	Yes	No
Module Inhibit - I ² C control	Yes	Yes	Yes	Yes	Yes
Module Inhibit - analog	Yes	Yes	Yes	Yes	No
Overvoltage/overcurrent protection	Yes	Yes	Yes	Yes	Yes
Minimum load required	No	No	No	No	No
Slots occupied in any iMP case	1	2	3	1	1

Output Module Voltage/Current

Voltage	Voltage Code	Single Output Module Code			Dual Output**		Triple Output			I ² C Adjustment Ranges
		1	2	3	V1	V2	-	-	-	
2 V	A	35 A	60 A	150 A	10 A	10 A	-	-	2 A	1.8-6.6
2.2 V	B	35 A	60 A	150 A	10 A	10 A	-	-	2 A	
3 V	C	35 A	60 A	150 A	10 A	10 A	-	-	2 A	
3.3 V	D	35 A	60 A	150 A	10 A	10 A	-	-	2 A	
5 V	E	35 A	60 A	150 A	10 A	10 A	-	-	2 A	
5.2 V	F	35 A	60 A	144 A	10 A	10 A	-	-	2 A	
5.5 V	G	34 A	58 A	136 A	10 A	10 A	-	-	2 A	
6 V	H	23 A	42 A	97.5 A	10 A***	10 A***	-	-	2 A	
8 V	I	20 A	36 A	84.4 A	10 A	4 A	1 A	1 A	1 A	7.2-16.5
10 V	J	18 A	32 A	75 A	10 A	4 A	1 A	1 A	1 A	
11 V	K	17 A	31 A	68 A	10 A	4 A	1 A	1 A	1 A	
12 V	L	17 A	30 A	62.5 A	10 A	4 A	1 A	1 A	1 A	
14 V	M	14 A	21 A	53.5 A	9 A	4 A	1 A	1 A	1 A	
15 V	N	14 A	20 A	50 A	8 A	4 A	1 A	1 A	1 A	
18 V	O	11 A	19 A	41.6 A	-	-	-	0.5 A	0.5 A	16.2-22.0
20 V	P	10.5 A	18 A	37.5 A	-	-	-	0.5 A	0.5 A	
24 V	Q	8.5 A	15 A	30 A	4 A	2 A	-	0.5 A	0.5 A	21.6-33.0
28 V	R	6.7 A	11 A	26.8 A	3 A	2 A	-	0.5 A	0.5 A	
30 V	S	6.5 A	11 A	25 A	-	-	-	-	-	29.7-66.0
33 V	T	6.2 A	10.9 A	22.7 A	-	-	-	-	-	
36 V	U	5.8 A	10 A	20.8 A	-	-	-	-	-	
42 V	V	4.2 A	7.5 A	16 A	-	-	-	-	-	
48 V	W	4 A	7.5 A	15.6 A	-	-	-	-	-	
54 V	X	3.7 A	6 A	13.9 A	-	-	-	-	-	
60 V	Y	3.5 A	6 A	12.5 A	-	-	-	-	-	
Non-std*	Z	Special Voltage - Consult factory for specifications								

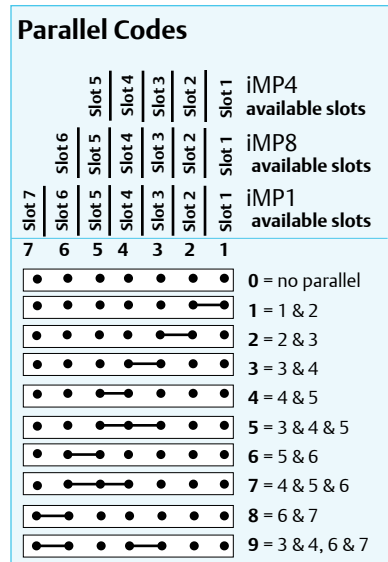

* Note: Increments of current not shown can be achieved by paralleling modules (add currents of each module selected).
** Total loading of outputs on dual module not to exceed 144 W.
*** Consult factory

Ordering Information

Sample below is 1500 W case with 12 V @ 62.5 A; 5 V @ 60 A; 24 V @ 8.5 A; 12 V @ 10 A; 12 V @ 4 A; with no options.

Case Size	Module/Voltage/Option Codes	Case Option Codes	Software Code	Hardware Code
iMP1*	3L0 - 2E2 - 1Q1 - 4LL0	00	A	###
<p>Case Size (mm) 4 = 2.5" x 5" x 10"; 750-1100 W, 5 slots (63.5 x 127 x 254) 8 = 2.5" x 7" x 10"; 1000-1200 W, 6 slots (63.5 x 177.8 x 254) 1 = 2.5" x 8" x 11"; 1200-1500 W, 7 slots (63.5 x 203.2 x 279.4)</p> <p>*Note: Add "E" after iMP4 to denote IEC input option. e.g., iMP4E (Not available on iMP8 or iMP1)</p>	<p>Module Codes Module/voltage/option codes Module codes: (None) = 36 W triple O/P (1 slot) 1 = 210 W single O/P (1 slot) 2 = 360 W single O/P (2 slot) 3 = 750 W single O/P (3 slot) 4 = 144 W dual O/P (1 slot) 5 - 9 = future</p> <p>Voltage Codes: See Output Module Voltage/Current table above</p> <p>Option Codes: 0 = Standard 1 = Module enable 2 = Constant current 3 = 1 & 2 combined 4 = Set for use in standard (non-intelligent case) 5 - 4 = Future</p>	<p>Case Option Codes</p> <p>First digit 0 - 9 = parallel code (See Parallel Codes table above)</p> <p>Second digit 0 = No options 1 = Reverse air 3 = Global enable 4 = Fan off w/inhibit 5 = Opt 1 + Opt 3 6 = Opt 1 + Opt 4 7 = Opt 3 + Opt 4 8 = Opt 1 + 3 + 4 9 = CAN BUS/RS-485 73-544-002 B = USB 73-546-002</p>	<p>Software code used for configuration change. "A" is standard</p>	<p>Factory assembled for hardware of firmware mods.</p>

Ordering Note:
1. The cases and modules of both MP and iMP series can be interchanged to allow more flexibility. If intelligent modules are used with non-intelligent cases, a numeric code "4" is placed at the end of the module code (ex. 4LL0 becomes 4LL4).
2. USB to I²C module order code 73-769-001

Case Specifications



210 W

iMP4 (AC input on opposite side)

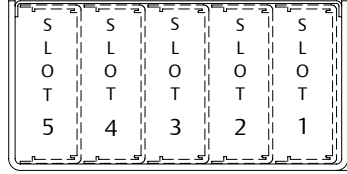

iMP4 = 2.5" x 5" x 10" (63.5 x 127 x 254 mm)
5 available slots

Input
90-264 Vac 750 W max.
180-264 Vac 1100 W max.



360 W

iMP8 and iMP1

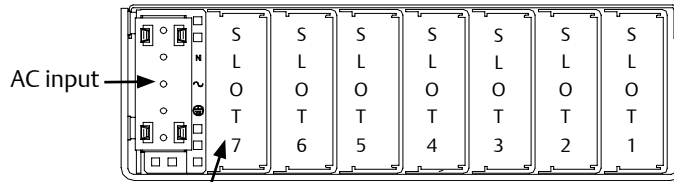

iMP8 = 2.5" x 7" x 10" (63.5 x 177.8 x 254 mm)
6 available slots

iMP1 = 2.5" x 8" x 11" (63.5 x 203.2 x 279.4 mm)
7 available slots

Input
85-264 Vac 1000 W max.
180-264 Vac 1200 W max.



750 W
Single

Pin Connectors

Figure 1. AC Input



AC Input

Pin No.	Function
1	AC neutral
2	AC line (hot)
3	Chassis (earth) ground

Figure 2. Connector

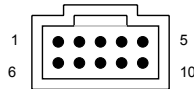

Mates with
Molex 90142-0010

PFC Input Connector (control and signals)

Pin No.	Function
1	Input AC OK - "emitter"
2	Input AC OK - "collector"
3	Global DC OK - "emitter"
4	Global DC OK - "collector"
5	External Sync
6	Global inhibit/optional enable logic "0"
7	Global inhibit/optional enable logic "1"
8	Global inhibit/optional enable return
9	+5 Vsb housekeeping
10	+5 Vsb housekeeping return



144 W
Dual

Figure 3. Connector J2

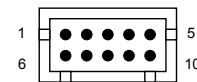

Mates with
Landwin 2050S1000 Housing
2053T011P Pin
Connector
Kit order # 73-841-023

I²C Bus Output Connector

Pin No.	Function
1	No connection
2	No connection
3	No connection
4	Serial clock signal (SCL)
5	Serial data signal (SDA)
6	Address bit 0 (AO)
7	Address bit 1 (A1)
8	Address bit 2 (A2)
9	Secondary return (GND)
10	5 Vcc external bus (5 Vcc Bus)



36 W
Triple

Intelligent VS Series

Intelligent modular power supply for optimum flexibility

Up to 4920 Watts

Total Power: Up to 4920 Watts
 Input Voltage: 85-264 Vdc
 120-300 Vdc
 # of Outputs: Up to 24



iVS1-3E0-210-2Q0-1WD-00-A

Special Features

- Full medical EN60601 approval
- Intelligent I²C control
- Voltage adjustment on all outputs (manual or I²C)
- Configurable input and output OK signals and indicators
- Configurable inhibit/enable
- Configurable output UP/DOWN sequencing
- High power density (12 W/cu-in)
- Intelligent fan (speed control/fault status)
- μ P controlled PFC input with active Inrush protection
- I²C monitor of voltage, current, and temp
- Programmable voltage, current limit, inhibit/enable through I²C
- CAN BUS and RS-485 interface option
- Optional extended hold-up module (SEMI F47 compliance)
- Increased power density to 150%
- Optional conformal coating
- Industrial temp range (-40 °C to 70 °C)
- Uses standard iMP modules
- Field upgradeable firmware
- RoHS compliant

Electrical Specifications

Input	
<i>Input range</i>	
iVS1 & iVS3:	90-264 Vac 1 \emptyset : 120-300 Vdc
iVS6 & iVS8:	170-264 Vac 3 \emptyset
iVS8H:	480 Vac nominal 3 \emptyset 380 Vac nominal 3 \emptyset derate to 3800 W max.
Frequency	47-440 Hz
Inrush current	40 A peak maximum (soft start)
Efficiency	Up to 85% @ full case load
Power factor	0.99 typ. meets EN61000-3-2
Turn-on time	AC on 1.5 sec typical, inhibit/enable 150 ms typical. Programmable
EMI Filter	CISPR 22/EN55022 Level "B"
Leakage current	300 μ A max. @ 240 Vac; 47-63 Hz
Radiated EMI	CISPR 22/EN55022 Level "B"
Holdover storage	10 ms minimum (independent of input Vac) additional 20 ms holdover storage with optional HUP module (SEMI F47 compatible)
AC OK	>5 ms early warning minutes before outputs lose regulation. Full cycle ride thru (50 Hz). Programmable
Harmonic distortion	Meets EN61000-3-2
Isolation	Meets EN60950 and EN60601
Global inhibit/enable	TTL, Logic "1" and Logic "0"/configurable
Warranty	Three years



210 W



360 W



750 W



1500 W

Single



144 W

Dual



36 W

Triple

Environmental Specifications

Output	
Adjustment range*	±10% minimum all outputs (manual) (full module adjustment range using I ² C)
Margining	±4-6% nominal analog (single output module only)
Overall regulation	0.4% or 20 mV max. (1500 W modules 1% max.)
Ripple	RMS: 0.1% or 10 mV, whichever is greater Pk-Pk: 1.0% or 50 mV, whichever is greater Bandwidth limited to 20 MHz
Dynamic response	<2% or 100 mV, with 25% load step
Recovery time	To within 1% in <300 μ second
Overcurrent protection**	Configurable through I ² C. single output module and main output of the dual output module 105-120% of rated output current. Aux output of dual output module 105-140% of rated output current. Special programmable OCP delay on 1500 W module from 100 ms to 25.5 seconds with shutdown features
Short-circuit protection	Protected for continuous short-circuit Recovery is automatic upon removal of short (Shutdown mode on 1500 W module)
Overvoltage protection*	Configurable through I ² C
– Single output module	2-5.5 V 122-134%; 6-60 V 110-120%
– Dual output module	2-6 V 122-134%; 8-28 V 110-120%
– Triple output module	No overvoltage protection provided
Reverse voltage protection	100% of rated output current
Thermal protection*	Configurable through I ² C All outputs disabled when internal temp exceeds safe operating range. > 5 ms warning (AC OK signal) before shutdown
Remote sense	Up to 0.5 V total drop (not available on triple output module)
Single wire parallel	Configurable through firmware Current share to within 2% of total rated current
DC OK*	+/-5% of nominal. Configurable through I ² C
Minimum load	Not required
Housekeeping bias voltage	5 Vdc @1.0 A max. present whenever AC input is applied
Module inhibit*	Configured and controlled through I ² C
Switching frequency	250 kHz accepts external sync signal
Output/Output isolation	>1 Megohm, 500 V

Operating temperature	-40 ° to 70 °C ambient. Derate each output 2.5% per degree from 50 ° to 70 °C. (-20 °C start up)
Storage temperature	-40 °C to 85 °C
Electromagnetic susceptibility	Designed to meet EN61000-4; -2, -3, -4, -5, -6, -8, -11 Level 3
Humidity	Operating; non-condensing 10% to 95% RH
Vibration	IEC68-2-6 to the levels of IEC721-3-2
MTBF demonstrated	>550,000 hours at full load, 220 Vac and 25 °C ambient conditions

Safety

UL	UL60950/UL2601 (cCSAus)
CSA	CSA22.2 No. 234 Level 5
VDE	EN60950/EN60950-1
BABT	Compliance to EN60950/ EN60601 BS7002
CB	Certificate and report
CE	Mark to LVD

* Can be controlled via I²C

** Controlled via I²C but requires load calibration

Output Module Line-up

Module Code	1	2	3	5	4	
Module Type	Single	Single	Single	Single	Dual	Triple
Max output power	210 W	360 W	750 W	1500 W	144 W	36 W
Max output current	35 A	60 A	150 A	140 A	10 A	2 A
Output voltages available*	2-60 V	2-60 V	2-60 V	6-60 V	6 - 15, 24 - 28; 6 - 15; 6 - 15; 6 - 15; 2 - 6; 2 - 6, 2 - 6; 24 - 28, 24 - 28; 24 - 28; 2 - 6	8-15, 8-15, 2-6; 8-15, 8-15, 8-15; 8-15, 8-15, 18-28; 8-15, 18-28, 2-6
Standard voltage increments	25	25	25	18	16	18
Remote sense	Yes	Yes	Yes	Yes	Yes	Yes
Remote margin*	Yes	Yes	Yes	Yes	No	No
V-Program - I ² C Control*	Yes	Yes	Yes	Yes	Yes	Yes
Active Current Share	Yes	Yes	Yes	Yes	Yes	No
Module Inhibit - I ² C Control*	Yes	Yes	Yes	Yes	Yes	Yes
Module Inhibit - Analog	Yes	Yes	Yes	Yes	No	No
Overvoltage/Overcurrent protection*	Yes	Yes	Yes	Yes	Yes	Yes
Minimum load required	No	No	No	No	No	No
Slots occupied in any iMP case	1	2	3	4	1	1

* Programmable



Output Module Voltage/Current*

Voltage	Voltage Code	Single Output Module Code				Dual Output**		Triple Output			I ² C Adjustment Ranges
		1	2	3	5	V1	V2				
2 V	A	35 A	60 A	150 A	—	10 A	10 A	—	—	2 A	1.8-2.2
2.2 V	B	35 A	60 A	150 A	—	10 A	10 A	—	—	2 A	2.0-2.4
3 V	C	35 A	60 A	150 A	—	10 A	10 A	—	—	2 A	2.7-3.3
3.3 V	D	35 A	60 A	150 A	—	10 A	10 A	—	—	2 A	3.0-3.6
5 V	E	35 A	60 A	150 A	—	10 A	10 A	—	—	2 A	4.5-5.5
5.2 V	F	35 A	60 A	144 A	—	10 A	10 A	—	—	2 A	4.7-5.7
5.5 V	G	34 A	58 A	136 A	—	10 A	10 A	—	—	2 A	5.0-6.1
6 V	H	23 A	42 A	97.5 A	140 A	10 A***	10 A***	—	—	2 A	5.4-6.6
8 V	I	20 A	36 A	84.4 A	140 A	10 A	4 A	1 A	1 A	1 A	7.2-8.8
10 V	J	18 A	32 A	75 A	140 A	10 A	4 A	1 A	1 A	1 A	9.0-11.0
11 V	K	17 A	31 A	68 A	136.3 A	10 A	4 A	1 A	1 A	1 A	9.9-12.1
12 V	L	17 A	30 A	62.5 A	125 A	10 A	4 A	1 A	1 A	1 A	10.8-13.2
14 V	M	14 A	21 A	53.5 A	107 A	9 A	4 A	1 A	1 A	1 A	12.6-15.4
15 V	N	14 A	20 A	50 A	100 A	8 A	4 A	1 A	1 A	1 A	13.5-16.5
18 V	O	11 A	19 A	41.6 A	83.3 A	—	—	—	0.5 A	0.5 A	16.2-19.8
20 V	P	10.5 A	18 A	37.5 A	75 A	—	—	—	0.5 A	0.5 A	18.0-22.0
24 V	Q	8.5 A	15 A	30 A	62.5 A	4 A	2 A	—	0.5 A	0.5 A	21.6-26.4
28 V	R	6.7 A	11 A	26.8 A	53.5 A	3 A	2 A	—	0.5 A	0.5 A	25.2-30.8
30 V	S	6.5 A	11 A	25 A	50 A	—	—	—	—	—	27.0-33.0
33 V	T	6.2 A	10.9 A	22.7 A	35.8	—	—	—	—	—	29.7-36.3
36 V	U	5.8 A	10 A	20.8 A	35.8	—	—	—	—	—	32.4-39.6
42 V	V	4.2 A	7.5 A	16 A	35.7	—	—	—	—	—	37.8-46.2
48 V	W	4 A	7.5 A	15.6 A	31.2	—	—	—	—	—	43.2-52.8
54 V	X	3.7 A	6 A	13.9 A	27.7	—	—	—	—	—	48.6-59.4
60 V	Y	3.5 A	6 A	12.5 A	25	—	—	—	—	—	54.0-66.0
Consult Factory											
Special	Z	35 A	60 A	150 A	—	—	10 A	—	—	—	2.3-2.6
Special	Z	35 A	60 A	150 A	—	—	10 A	—	—	—	3.7-4.4
Special	Z	20 A	36 A	80 A	140 A	—	8 A	—	—	—	6.7-7.1

* Note: Increments of current not shown can be achieved by paralleling modules (add currents of each module selected)

** Total leading of outputs on dual module not to exceed 144 W.

*** Consult factory

Ordering Information

Sample below is 3210 W case with 12 V @ 125 A; 24 V @ 8.5 A; 5 V @ 60 A; 12 V @ 10 A and 12 V @ 4 A; with no options.

Case Size	Module/Voltage/Option Codes	Case Option Codes	Software Code	Hardware Code
iVS1	5L1 - 1Q1 - 2EO - 4LL0	00	A	###
<p>Case Size (mm) 1-Phase Input 1 = 5" x 5" x 11"; 1500-3210 W, 9 slots (127 x 127 x 279.4) 3 = 5" x 8" x 11"; 1800-4170 W, 15 slots (127 x 203.2 x 279.4) 3-Phase Input 6 = 5" x 5" x 11"; 3120 W, 9 slots (127 x 127 x 279.4) 8 = 5" x 8" x 11"; 4170 W, 15 slots (127 x 203.2 x 279.4) 8H = 5" x 8" x 11"; 4860 W, 14 slots (127 x 203.2 x 279.4)</p>	<p>Module Codes Module/voltage/option codes Module Codes: (None) = 36 W triple O/P (1 slot) 1 = 210 W single O/P (1 slot) 2 = 360 W single O/P (2 slot) 3 = 750 W single O/P (3 slot) 5 = 1500 W single O/P (slot 4) 4 = 144 W dual O/P (1 slot) HUP = Extra 30mS hold-up (1 slot) Voltage Codes: See Output Module Voltage/Current table above Option Codes: 0 = Standard 1 = Module enable 2 = Constant current 3 = 1 & 2 combined 4 = Set for use in standard (non-intelligent case) 5 = Shutdown mode for 1500 W 6 = 1 & 5 combined 7-9 Future</p>	<p>Case Option Codes First Digit 0 - 9 = Parallel code (See parallel codes table in datasheet) Second Digit 0 = No options 1 = Reverse air 2 = Not used 3 = Global enable 4 = Fan Off w/inhibit 5 = Opt 1 + Opt 3 6 = Opt 1 + Opt 4 7 = Opt 3 + Opt 4 8 = Opt 1 + 3 + 4 9 = CAN BUS/RS-485 73-544-001 B = USB 73-546-001 M = Medical N = M + 1 P = M + 3 R = M + 1 + 3</p>	<p>Software code used for configuration change. "A" is standard</p>	<p>Factory assembled for hardware of firmware mods.</p>
<p>Ordering Note: 1. USB to I²C module order code 73-769-001</p>				

Case Specifications

iVS1 and iVS6

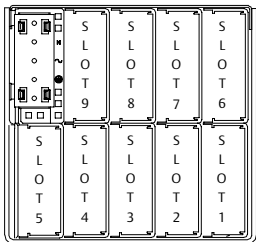

iVS1 = 5" x 5" x 11" (127 x 127 x 254)
9 available slots

iVS6 = 5" x 5" x 11" (127 x 127 x 254)
9 available slots

Input	
100-264 Vac 1500 W max.	180-264 Vac 3210 W max.
N/A	3200 W max.

iVS3 and iVS8

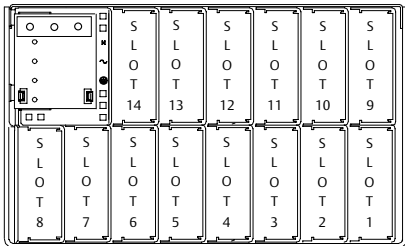

iVS3 & 8 = 5" x 8" x 11" (127 x 177 x 254)
14 available slots

iVS3 & 8 = 5" x 8" x 11" (127 x 177 x 254)
14 available slots

Input	
100-264 Vac 1800 W max.	180-264 Vac 4920 W max.
	480 Vac 4920 W max.

Pin Connectors

Figure 1. AC Input

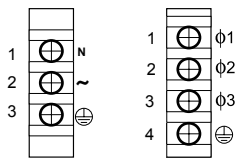

AC Input Pin No.	Single Phase Function	3 Phase
1	AC neutral	Φ1
2	AC line (hot)	Φ2
3	Chassis (earth) ground	Φ3
4	Chassis (earth) ground	⊕

Figure 2. Connector J1

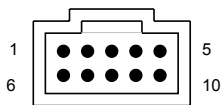

Mates with

Molex 90142-0010
Amp 87977-3

PFC Input Connector (control and signals)

Pin No.	Function
1	Input AC OK - "emitter"
2	Input AC OK - "collector"
3	Global DC OK - "emitter"
4	Global DC OK - "collector"
5	No connection
6	Global inhibit/optional enable logic "0"
7	Global inhibit/optional enable logic "1"
8	Global inhibit/optional enable return
9	+5 Vsb housekeeping
10	+5 Vsb housekeeping return

Ordering Note:

For possible iVS configurations, please see datasheet.

Figure 3. Connector J2

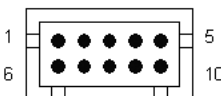

Mates with

Landwin 2050S1000 housing
2053T011P pin

I²C Bus Output Connector

Pin No.	Function
1	No connection
2	No connection
3	No connection
4	Serial clock signal (SCL)
5	Serial data signal (SDA)
6	Address bit 0 (A0)
7	Address bit 1 (A1)
8	Address bit 2 (A2)
9	Secondary return (GND)
10	5 Vcc external bus (5 Vcc bus)

Bulk Power (HPS & UFE)

350-6000 Watts

Special Features

- EN61000-3-2 harmonic compliance
- Built-in EMI filter
- Low output ripple
- +5 V standby output
- Built-in cooling fans
- Hot swap/N + 1 redundant
- Overcurrent protection
- Overvoltage protection
- Overtemperature protection
- Built-in OR'ing diodes
- Active power factor correction

New Features Coming Soon

- 500 W HPS50
- HPR12K rack for HPS3000

Voltage Availability

Model	HPS3000	HPS35	HPS15	UFE
Wattage	3000 W ⁴	350 W	1500 W ³	2000 W ⁵
Input Voltage	90-140 Vac 180-264 Vac	90-264 Vac	90-265 Vac	90-265 Vac
Available Standard Output Voltages (order code)¹				
12 (L)		•		
24 (Q)		•	•	•
28 (R)			•	•
30 (S)			•	
48 (W)	•	•	•	•
54 (X)		•	•	•
60 (Y)			•	
Available Options	See Note 1	See Note 1	See Note 1	
Corresponding Rack	See Note 2	HPR1-00	HPR3-00	UFR6000J

Notes: 1 = Consult factory for other output voltages and options
 2 = Comes with I²C interface
 3 = 1200 W @ 90-264 Vac; 1500 W @ 100-264 Vac
 4 = 3000 W @ 180-264 Vac; 1500 W @ 90-140 Vac
 5 = 2000 W @ 48 V; 1300 W @ 24 V

Environmental Specifications

HPS15 and HPS35	
Operating temp.	-10 °C to 50 °C ambient (derate output @ 2.5% per degree from 50 °C to 70 °C)
HPS3000	
Operating temp.	-10 °C to 40 °C
Storage temp.	-40 °C to 85 °C
Cooling	External fans with Fan Fail and Fan Speed control
Humidity	Operating/Storage: 5-95% non-condensing
Altitude	Operating: Up to 10,000 feet above sea level Storage: Up to 30,000 feet above sea level
Vibration/Shock	Non-operational 5G Sine sweep from 5-500 Hz, dwelling at resonant frequencies for one hour each
RoHS compliant	Yes

Safety

UL	UL60950 (UL recognized)
NEMKO	EN60950
TÜV	EN60950
CE	Mark
CB	Report



HPS3000

HPS3000 Electrical Specifications

Input	
Input range (operating)	180-264 Vac 90-140 Vac
Input range (nominal)	200 Vac 110 Vac
Frequency	43-63 Hz
Input fusing	Internal 25 A fuses (both lines fused)
Inrush current	≤40 A peak (either hot or cold start)
Power factor	0.97 typical (Meets EN61000-3-2)
Harmonics	Meets IEC 1000-3-2 requirements @ 50% load
Input current	19 A max input current
Holdup time	10 ms min @ full rated load
Leakage current	1.4 mA @ 240 Vac
Power line transient	MOV directly after the fuse
Output	
Output rating	48 V @ 62.0 A (180-264 Vac) 5 Vsb @ 3.0 A 48 V @ 29.4 A (90-140 Vac) 5 V @ 3 A
Set point	48 V (Programmable ±10% through I ² C serial bus)
Total regulation range	48 V ± 10%; 5 Vsb ± 4% (line/load/transient when measured at output connection)
Rated load	3000 W maximum @ 200 Vac Input 1500 W maximum @ 110 Vac Input (no derating over operating temperature range)
Minimum load	48 V @ 0.0 A 5; Vsb @ 0.0 A with no loss of regulation
Output noise	480 mV max P-P for 48 V output 100 mV max P-P for 5 Vsb output Measured with a 0.1µF Ceramic and 10 µF Tantalum capacitor on any input
Output voltage overshoot	± 5% maximum of nominal voltage setting
Transient response	5% maximum deviation (50% load step @ 1 A/us. Step load valid between 10-100% of output rating)
Max units in parallel	Up to 4 (total power in 1U 19" rack is 12 KW)
Short circuit protection	120-130% of rated output (output to return)
Output isolation	Per POE specs (>2000 Vac)
Forced load sharing	Within 10% of all shared outputs (digital sharing control)
Overcurrent protection (OCP)	120-130% for 48 V output 100-125% for 5 Vsb output
Overvoltage protection (OVP)	110-120% for 48 V output 110-125% for 5 Vsb output
Overtemperature protection	10 °C to 15 °C above safe operating area. (Both PFC and output converter monitored. 5 Vsb will operate under overtemperature condition. Built-in hysteresis.)

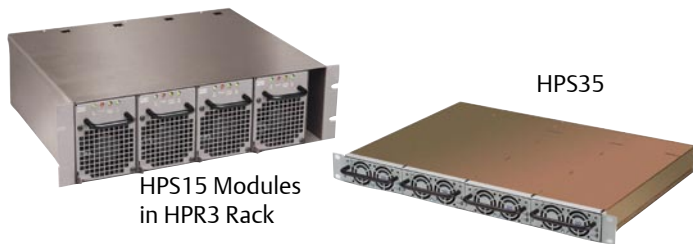

HPS35 Electrical Specifications

Input	
Input voltage	90-264 Vac typical
Frequency	47-440 Hz
Inrush current	40 A peak max. @ 25 °C
Efficiency	80% typical @ full load, 230 Vac
Power factor	0.99 typical @ 115 Vac, full load
Turn-on time	AC on 2 sec; inhibit/enable 160 ms typical
EMI filter standard	CISPR 22; EN55022 Level "B"
Leakage current standard	<0.5 mA max @ 230 Vac @ 60 Hz per module
Radiated EMI	CISPR 22; EN55022 Level "B"
Holdover time	20 ms minimum (independent of input Vac)
AC OK	5 ms early warning minutes before outputs lose regulation
Harmonic distortion	Meets EN61000-3-2
Isolation	Meets EN60950
Output	
Adjustability	±5% of nominal output voltage
Overall regulation	±2%
Ripple	1% of Vout Pk-Pk (20 MHz bandwidth)
Dynamic response	4% with 25% load step
Recovery time	To within 1% in <300 µsec
Overcurrent protection	115-130% of rated output current
Short-circuit protection	Protected for continuous short-circuit Auto recovery
Overvoltage protection	120-140%. AC Reset
Reverse voltage protection	100% of rated output current
Thermal protection	Main and Aux disabled when internal temperature exceeds safe operating range
Remote sense	Up to 0.5 V total drop
Single wire parallel	Current share to within 10% of total rated current on main output
DC OK	±5% of nominal
Minimum load*	Not required (when used as stand-alone module)
Standby voltage	5 Vdc @ 2 A maximum present whenever AC input is applied
Global inhibit	Logic "0"

* 3 A minimum for current share operation

Rack Ordering Information

Module	UFE1300/2000	HPS3000	HPS35	HPS15
Rack #	UFR6000	NA	HPR1-00**	HPR3-00**
# of Slots	3	NA	4	4
Total Power	6000 W	NA	1400 W	6000 W

**See website for option codes on HPR racks.

HPS15 Electrical Specifications

Input	
Input voltage	1200 W @ 90-264 Vac 1500 W @ 180-264 Vac
Frequency	47-440 Hz
Inrush current	40 A peak max. @ 25 °C
Efficiency	85% typ. @ full load, 230 Vac
Power factor	0.99 typ. meets EN61000-3-2
Turn-on time	AC on 1.5 sec typical Inhibit/enable 100ms typical
EMI filter standard	CISPR 22; EN55022 Level "B"
Leakage current standard	2 mA max @ 264 Vac @ 60 Hz per module
Radiated EMI	CISPR 22; EN55022 Level "B"
Holdup time	20 ms minimum (independent of input Vac)
AC OK	>5 ms early warning min. before outputs lose regulation. Full cycle ride thru (50 Hz)
Harmonic distortion	Meets EN61000-3-2
Isolation	Meets EN60950
Output	
Margining	±5% of nominal
Overall regulation	±1%
Ripple	1% of Vout Pk-Pk limited to 20 MHz
Dynamic response	2% with 25% load step
Recovery time	To within 1% in <300 µsec
Overcurrent protection	105-120% of rated output current
Short-circuit protection	Protected for continuous short-circuit Recovery is automatic upon removal of short
Overvoltage protection	105-120%. Recycle AC input voltage to reset OVP circuit
Reverse voltage protection	100% of rated output current
Thermal protection	Main and Aux disabled when internal temp exceeds safe operating range.
Remote sense	Up to 0.5 V total drop
Single wire parallel	Current share to within 10% of total rated current
DC OK	±5% of nominal
Minimum load*	Not required
Standby voltage	5 Vdc @ 5 A max. present whenever AC input is applied (3.3 V @ 5 A optional)
Global inhibit	Logic "0" standard logic "1" optional

* 3 A minimum for current share operation

Ordering Information

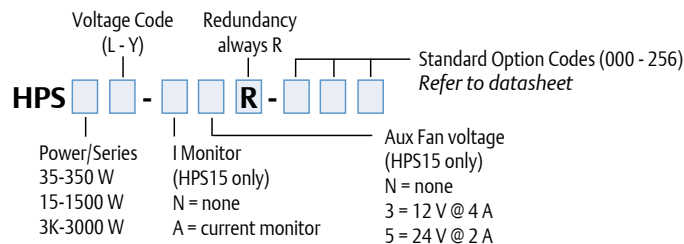

For the HPS3000, the ordering part number is HPS3000-9

UFE1300/2000 Electrical Specifications

Input	
Input range (operating)	88-264 Vac 176-264 Vac
Input range (nominal)	120 Vac 240 Vac
Frequency	47-63 Hz
Input fusing	30 A (both lines fused)
Power factor	0.98 (50-100% load)
Input current	15 A max.
Leakage current	2 mA max.
Undervoltage lockout (power up)	176 Vac max. (high line range) 88 Vac max. (wide range)
Undervoltage lockout (power down)	162 Vac min. (high line range) 76 Vac min. (wide range)

Output	
Output rating - Main output	48 V 2000 W (high line range) 48 V 1300 W (wide range) 24 V 1300 W (all ranges)
Output rating - Auxiliary output	11 V +/-15%, 2.875 W
Line regulation	+/-0.15% max.
Load regulation	+/-0.15% max.
Turn-on delay	5.0 seconds max.
Ambient temp. coefficient	+/-0.005%/°C
Voltage adjustability (via PMBus)	48 V 42-57 Vdc 24 V 21-28.5 Vdc
Output setpoint accuracy	±0.5%
Default output voltage (@ 25 °C)	48 V ± 0.5% @ 41 A 27 V ± 0.5% @ 48 A
Total error band	± 1.0% max.
Overshoot/undershoot	0%
Ripple and noise (20 MHz)	500 mV pk-pk, 150 mV rms
Dynamic regulation (except droop mode)	2.5% max., recovery in 1 ms max.
Current sharing	15% max.
Electrical insulation	4242 Vdc input/output
Switching frequency	450 kHz fixed
Power limit	115%
Current limit	108% typical
Short-circuit	200 ms on; 1/8 second off
Overvoltage	60 V/32 V
Overtemperature	Non-latching

UFE Power Shelf



UFE2000

Ordering Information

Product Family	Rated Output Power	Input Range	Standard Compliance	Type of Output	Output Voltage	Communications Type	Option Code	Special Modification	RoHS Compliance
UFE	2000	9	6	S	48	P	D	xx	J
UFE = Universal Front-End	1300 = 1300 Watts 2000 = 2000 Watts	9 = Universal Input with PFC	6 = UL/CSA/VDE Class A/B	S = Single	48 = 48 V 24 = 24 V	P = PMBus serial communications	None = Active Ishare D = Droop Ishare HD = PS Enable HI/Droop		J = Pb free (RoHS 6/6 compliant)

Rated Output Power	Output Voltage Vout		Output Current (Min)	Power Limit + 15% / -0% Vout (min)	Line Range at Turn On (Auto Ranging)	Operating Line Range	Current Limit (Vout) < Vout (min)	Model Numbers	Order Number
	Min	Max							
24 Vout Models									
1300 W	21 V	28.5 V	0 A	1300 W	90-264 Vac	65 A	65 A	UFE1300-96S24PJ	UFE1300-5
48 Vout Models									
1300 W	42 V	57 V	0 A	1300 W	90-264 Vac	33 A	33 A	UFE2000-96S48PJ	UFE2000-9
2000 W	42 V	57 V	0 A	2000 W	180-264 Vac	52 A	52 A		
1300 W	42 V	57 V	0 A	1300 W	90-264 Vac	33 A	33 A	UFE2000-96S48PDJ	UFE2000-9-HD
2000 W	42 V	57 V	0 A	2000 W	180-264 Vac	52 A	52 A		
1300 W	42 V	57 V	0 A	1300 W	90-264 Vac	33 A	33 A	UFE2000-96S48PHDJ	UFE2000-9-D
2000 W	42 V	57 V	0 A	2000 W	180-264 Vac	52 A	52 A		

Distributed Power Systems (DS)

AC and DC inputs available

450-2900 Watts

Special Features

- Active power factor correction
- EN61000-3-2 harmonic compliance
- Active AC inrush control
- High density
- Outputs +12 Vdc with some +48 Vdc models available
- 3.3 Vdc standby
- Options for 5 V standby voltage
- No minimum load required
- Hot plug operation
- N+1 redundant
- Internal OR'ing FETs
- Active current sharing
- Built-in cooling fans
- I²C Interface with EEPROM for FRU data
- Internal fan speed control with fan fail signal
- DC Input
- DSR1 rack for DS650/850.
Standard 19" 1U fits up to 5 modules (4250 Watts)
- DSR2 rack for DS1300/1500.
Standard 19" 2U fits up to 3 modules (4500 Watts)
- Gold efficiency standards on some models



DS450DC/DS2900



New Products and Features Coming Soon

- Options for reverse airflow
- Options for 5 V standby
- Platinum Plus efficiency on some models

Voltage Availability

Model	12 V (-3)	24 V (-5)	48 V (-9)	PMBus
DS450	•			
DS450DC	•			
DS460S	•			•
DS550	•			
DS550DC	•			
DS650	•	•	•	
DS650DC	•			
DS760SL	•			•
DS800SL	*			*
DS850	•	•	•	
DS850DC	•			
DS1050	•			•
DS1200	•			•
	•			•
DS1500	•			
DS2000	•			•
DS2900	•			•

Notes: • Available * Coming in late 2010

Safety

UL	UL60950 (UL recognized)
NEMKO	EN60950
TÜV	EN60950
CE	Mark
CB	Report

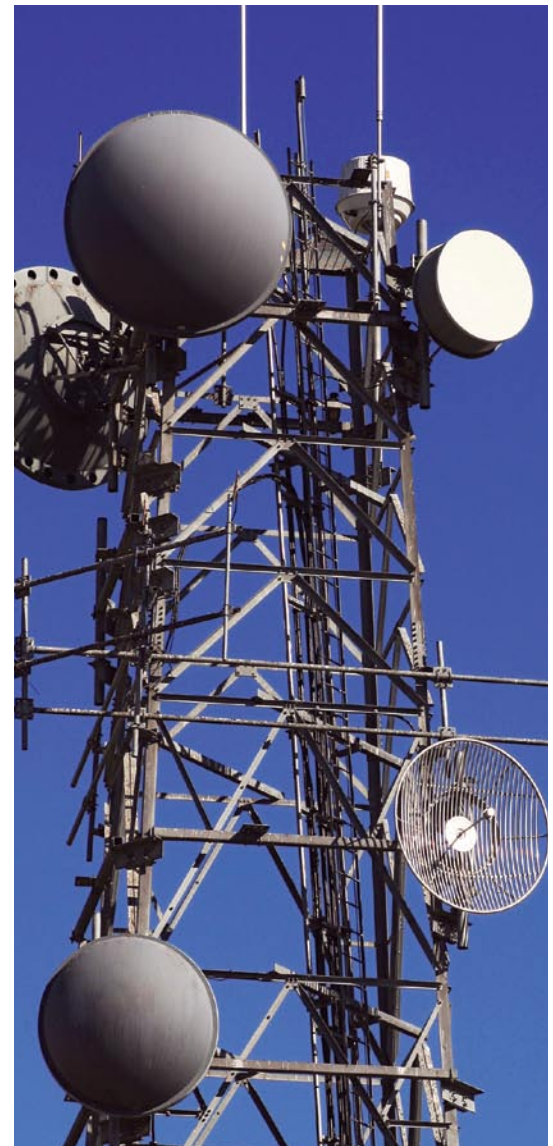



DS460

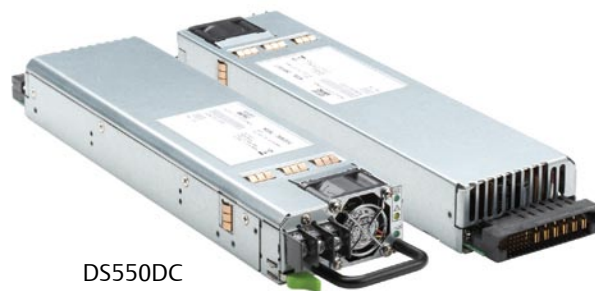

DS550DC

Electrical Specifications

Data	DS450-3	DS450DC-3	DS460S-3	DS550-3	DS550DC-3
Input					
Input Range	90-264 Vac	40-72 Vdc	90-264 Vac	90-264 Vac	40-72 Vdc
Frequency	47-63 Hz	DC	47-63 Hz	47-63 Hz	DC
Efficiency	80% Typ	80% Typ	92% Typ	80% Typ	80% Typ
EMI/RFI	Class B	N/A	Class B	Class B	N/A
Leakage Current	1.4 mA @ 240 V	N/A	1.0 mA @ 240 V	1.4 mA @ 240 V	N/A
Outputs					
Output Main	12 V / 37 A	12 V / 37 A	12 V / 38.2 A	12 V / 45 A	12 V / 45 A
Output Stand-By	3.3 Vsb / 3 A	3.3 Vsb / 3 A	12 Vsb / 2.5 A	3.3 Vsb / 3 A	3.3 Vsb / 3 A
OCP/OVP/OTP	YES	YES	YES	YES	YES
I ² C Control	YES	YES	YES	YES	YES
Environmental					
Operating Temp	-10 °C to 50 °C	-10 °C to 50 °C	-10 °C to 50 °C	-10 °C to 50 °C	-10 °C to 50 °C
Derating	N/A	N/A	N/A	N/A	N/A
Storage	-40 °C to +85 °C	-40 °C to +85 °C	-40 °C to +85 °C	-40 °C to +85 °C	-40 °C to +85 °C
RoHS Compliant	YES	YES	YES	YES	YES
MTBF	300K Hours	500K Hours	500K Hours	300K Hours	500K Hours
Other:					
Size (inch)	1.57 x 3.07 x 11.05	1.57 x 3.07 x 11.05	1.57 x 3.4 x 7.75	1.57 x 3.07 x 11.05	1.57 x 3.07 x 11.05
Size (mm)	40 x 78 x 280	40 x 78 x 280	40 x 86.4 x 197	40 x 78 x 280	40 x 78 x 280
Power Density	8.42	8.42	11.12	10.30	10.30
Cubic Inches	53.42	53.42	41.37	53.42	53.42
Pro-E Files	NO	YES	YES	NO	YES
Thermal Data	YES	YES	YES	YES	YES
PQ Airflow Curves	YES	YES	YES	YES	YES
Warranty	Two Year	Two Year	Two Year	Two Year	Two Year
Ordering Codes					
Standard	DS450-3	DS450DC-3	DS460S-3	DS550-3	DS550DC-3
ALT Standby	DS450-3-001	DS450DC-3-004		DS550-3-001	DS550DC-3-004
Reverse Air	DS450-3-002	DS450DC-3-002	DS460S-3-001	DS550-3-002	DS550DC-3-003
ALT Standby & Reverse Air	DS450-3-004	DS450DC-3-005		DS550-3-004	DS550DC-3-005
Fan Off with inhibit					
Disable External Fan Drive	DS450-3-003				



Data	DS650-3	DS650-5	DS650-9	DS650DC-3	DS760SL-3
Input					
Input Range	90-264 Vac	90-264 Vac	90-264 Vac	40-72 Vdc	90-264 Vac
Frequency	47-63 Hz	47-63 Hz	47-63 Hz	DC	47-63 Hz
Efficiency	80% Typ	80% Typ	82% Typ	80% Typ	90% Typ
EMI/RFI	Class B	Class B	Class B	N/A	Class A
Leakage Current	1.4 mA @ 240 V	1.4 mA @ 240 V	1.4 mA @ 240 V	N/A	0.8 mA @240 V
Outputs					
Output Main	12 V / 52.5 A	24 V / 26.3 A	48 V / 13.1 A	12 V / 52.5 A	12 V / 62.3 A
Output Stand-By	3.3 Vsb / 6 A	3.3 Vsb / 6 A	3.3 Vsb / 6 A	3.3 Vsb / 6 A	5.0 Vsb / 3.6 A
OCP/OVP/OTP	YES	YES	YES	YES	YES
I ² C Control	YES	YES	YES	YES	YES
Environmental					
Operating Temp	-10 °C to 50 °C	-10 °C to 50 °C	-10 °C to 50 °C	-10 °C to 50 °C	0 °C to 50 °C
Derating	50% at 70 °C	50% at 70 °C	50% at 70 °C	50% at 70 °C	N/A
Storage	-40 °C to +85 °C	-40 °C to +85 °C	-40 °C to +85 °C	-40 °C to +85 °C	-40 °C to +85 °C
RoHS Compliant	YES	YES	YES	YES	YES
MTBF	500K Hours	500K Hours	500K Hours	500K Hours	300K Hours
Other:					
Size (inch)	1.57 x 3.20 x 11.00	1.57 x 3.20 x 11.00	1.57 x 3.20 x 11.00	1.57 x 3.20 x 11.00	1.57 x 2.15 x 12.68
Size (mm)	40 x 81.3 x 279.4	40 x 81.3 x 279.4	40 x 81.3 x 279.4	40 x 81.3 x 279.4	40 x 54.5 x 322
Power Density	11.76	11.76	11.76	11.76	17.76
Cubic Inches	55.44	55.44	55.44	55.44	42.8
Pro-E Files	YES	YES	YES	YES	YES
Thermal Data	YES	YES	YES	YES	YES
PQ Airflow Curves	YES	YES	YES	YES	YES
Warranty	Two Year	Two Year	Two Year	Two Year	Two Year
Ordering Codes					
Standard	DS650-3	DS650-5	DS650-9	DS650DC-3	DS760SL-3
ALT Standby	DS650-3-002	DS650-5-001	DS650-9-002	DS650DC-3-002	
Reverse Air	DS650-3-007	DS650-5-002	DS650-9-004	DS650DC-3-003	DS760SL-3-001
ALT Standby & Reverse Air	DS650-3-008	DS650-5-003	DS650-9-005	DS650DC-3-004	
Fan Off with inhibit					
Disable External Fan Drive		DS650DC-3-001		DS850DC-3-001	



Data	DS800SL-3	DS850-3	DS850-5	DS850-9	DS850DC-3
Input:					
Input Range	90-264 Vac	90-264 Vac	90-264 Vac	90-264 Vac	40-72 Vdc
Frequency	47-63 Hz	47-63 Hz	47-63 Hz	47-63 Hz	DC
Efficiency	92% Typ GLD	82% Typ	82% Typ	83% Typ	80% Typ
EMI/RFI	Class A	Class B	Class B	Class B	N/A
Leakage Current	0.8 mA @240 V	1.4 mA @ 240 V	1.4 mA @ 240 V	1.4 mA @ 240 V	N/A
Outputs:					
Output Main	12 V / 66.7 A	12 V / 70 A	24 V / 35 A	48 V / 17.5 A	12 V / 70 A
Output Stand-By	5.0 Vsb / 4 A	3.3 Vsb / 6 A	3.3 Vsb / 6 A	3.3 Vsb / 6 A	3.3 Vsb / 6 A
OCP/OVP/OTP	YES	YES	YES	YES	YES
I ² C Control	YES	YES	YES	YES	YES
Environmental					
Operating Temp	0 °C to 50 °C	-10 °C to 50 °C	-10 °C to 50 °C	-10 °C to 50 °C	-10 °C to 50 °C
Derating	N/A	50% at 70 °C	50% at 70 °C	50% at 70 °C	50% at 70 °C
Storage	-40 °C to +85 °C	-40 °C to +85 °C	-40 °C to +85 °C	-40 °C to +85 °C	-40 °C to +85 °C
RoHS Compliant	YES	YES	YES	YES	YES
MTBF	500K Hours	500K Hours	500K Hours	500K Hours	500K Hours
Other:					
Size (inch)	1.57 x 2.15 x 12.68	1.57 x 3.20 x 11.00	1.57 x 3.20 x 11.00	1.57 x 3.20 x 11.00	1.57 x 3.20 x 11.00
Size (mm)	40 x 54.5 x 322	40 x 81.3 x 279.4	40 x 81.3 x 279.4	40 x 81.3 x 279.4	40 x 81.3 x 279.4
Power Density	18.69	15.38	15.38	15.38	15.38
Cubic Inches	42.8	55.44	55.44	55.44	55.44
Pro-E Files	YES	YES	YES	YES	YES
Thermal Data	YES	YES	YES	YES	YES
PQ Airflow Curves	YES	YES	YES	YES	YES
Warranty	Two Year	Two Year	Two Year	Two Year	Two Year
Ordering Codes					
Standard	DS800SL-3	DS850-3	DS850-5	DS850-9	DS850DC-3
ALT Standby		DS850-3-002	DS850-5-001	DS850-9-002	DS850DC-3-003
Reverse Air		DS850-3-006	DS850-5-002	DS850-9-003	DS850DC-3-004
ALT Standby & Reverse Air		DS850-3-008	DS850-5-003	DS850-9-004	DS850DC-3-005
Fan Off with inhibit		DS850-3-004			
Disable External Fan Drive					



Data	DS1050-3	DS1200-3	DS1200DC-3	DS1500-3	DS2000-3	DS2900
Input:						
Input Range	90-264 Vac	90-264 Vac	40-72 Vdc	90-264 Vac	90-264 Vac	180-264 Vac
Frequency	47-63 Hz	47-63 Hz	DC	47-63 Hz	47-63 Hz	47-63 Hz
Efficiency	92% Typ GLD	90% Typ	86% Typ	80% Typ	87% Typ	90% Typ
EMI/RFI	Class B	Class B	N/A	Class B	Class B	Class B
Leakage Current	1.4 mA @ 240 V	1.4 mA @ 240 V	N/A	1.4 mA @ 240 V	1.4 mA @ 240 V	1.4 mA @ 240 V
Outputs:						
Output Main	12 V / 85.5 A	12 V / 98 A	12 V / 98 A	12 V / 123 A	12 V / 165 A	12 V / 240 A
Output Stand-By	3.3 Vsb / 6 A	3.3 Vsb / 6 A	3.3 Vsb / 6 A	3.3 Vsb / 7 A	3.3 Vsb / 6 A	3.3 Vsb / 3 A
OCP/OVP/OTP	YES	YES	YES	YES	YES	YES
I ² C Control	YES	YES	YES	NO	YES	YES
Environmental						
Operating Temp	-10 °C to 50 °C	-10 °C to 50 °C	-10 °C to 50 °C	-10 °C to 50 °C	-10 °C to 50 °C	0 °C to 50 °C
Derating	50% at 70 °C	50% at 70 °C	50% at 70 °C	50% at 70 °C	N/A	N/A
Storage	-40 °C to +85 °C	-40 °C to +85 °C	-40 °C to +85 °C	-40 °C to +85 °C	-40 °C to +85 °C	-40 °C to +85 °C
RoHS Compliant	YES	YES	YES	YES	YES	YES
MTBF	500K Hours	500K Hours	500K Hours	500K Hours	500K Hours	500K Hours
Other:						
Size (inch)	1.57 x 3.20 x 11.00	1.57 x 3.20 x 11.00	1.57 x 3.20 x 11.00	2.8 x 4.9 x 7.5	1.57 x 4.2 x 11.6	3.07 x 4.17 x 8.5
Size (mm)	40 x 81.3 x 279.4	40 x 81.3 x 279.4	40 x 81.3 x 279.4	71.1 x 124.5 x 190.5	40 x 106.7 x 295.7	78 x 106 x 217
Power Density	18.95	21.71	21.71	12.63	26.2	26.7
Cubic Inches	55.44	55.44	55.44	102.9	76.5	108.8
Pro-E Files	YES	YES	YES	YES	YES	YES
Thermal Data	YES	YES	YES	YES	YES	YES
PQ Airflow Curves	YES	YES	YES	YES	YES	YES
Warranty	Two Year	Two Year	Two Year	Two Year	Two Year	Two Year
Ordering Codes						
Standard	DS1050-3	DS1200-3	DS1200DC-3	DS1500-3	DS2000-3	DS2900-3
ALT Standby	DS1050-3-002	DS1200-3-002	DS1200DC-3-002		DS2000-3-002	DS2900-3-002
Reverse Air	DS1050-3-001	DS1200-3-003	DS1200DC-3-001	DS1500-3-001	DS2000-3-001	DS2900-3-001
ALT Standby & Reverse Air	DS1050-3-003	DS1200-3-004	DS1200DC-3-003			DS2900-3-003
Fan Off with inhibit			DS850-3-004			
Disable External Fan Drive						

DIN Rail ADN-C Series

120-480 Watts

Special Features

- Slim form factor
- Five year warranty
- High efficiency > 90% Typ.
- Full power at 60 °C
- Power Boost™
- Industrial Grade Design
 - Patented metal mounting clip
 - Metal case
- MTBF > 450,000h demonstrated at 40 °C
- Active PFC > 0.92
- Adjustable output
- Overvoltage protection with auto recovery
- Continuous short-circuit and overload protection
- SEMI F47 Sag Immunity
- New visual diagnostic LED
- Three Status LEDs
 - Input, Output, Alarm
- DC OK Relay
- Parallel operation capability
- Screw terminal connections
- RoHS compliant
- No tools required for mounting

Models Coming Soon

- 40 A single phase
- Three-phase



Electrical Specifications

Input	
AC Input range	Nominal: 115-230 Vac 85-264 Vac
DC Input range	90-375 Vdc
Frequency	47-67 Hz, 400 Hz
Efficiency	> 90%
Inrush current	ADN5-24-1PM-C: < 15 A ADN10-24-1PM-C: < 30 A ADN20-24-1PM-C: < 40 A
PFC	Active, better than 0.92

Output	
Nominal voltage	ADN5-24-1PM-C & ADN10-24-1PM-C: 24 Vdc (22.5-28.5 Vdc Adj) ADN20-24-1PM-C: 24 Vdc (24-28 Vdc Adj)
Initial voltage setting	24.5 V ± 1%
Hold-up time	> 20 ms at full load (100 Vac Input @ Tamb = +25 °C)
Voltage regulation	< ± 2% (combination line, load, time and temperature related changes)
Ripple	ADN5-24-1PM-C & ADN10-24-1PM-C: < 50 mVpp ADN20-24-1PM-C: < 100 mVpp
Back EMF immunity	< 35 Vdc
Power Boost™	1.5 x Nominal current for 4 seconds.
Short-circuit current	1.5 x Nominal current at near zero volts at short-circuit condition
Parallel operation	Switch selectable single unit or parallel unit operation. Units will not be damaged by parallel operation (regardless of switch position setting)
Output noise suppression	Radiated EMI values below EN61000-6-2
Overvoltage protection	> 30.5 Vdc but < 33 Vdc, auto recovery
Line and load regulation	< 0.5%
Time and temperature drift	< 1%



Power	Voltage	Current	Size L x W x H (mm)	Weight	Model Number
120 W	85-264 Vac 90-375 Vac	5 A	4.85" x 1.97" x 4.37" (123 x 50 x 111)	1.65 lbs (750 g)	ADN5-24-1PM-C
240 W	85-264 Vac 90-375 Vac	10 A	4.85" x 2.36" x 4.37" (123 x 60 x 111)	1.98 lbs (900 g)	ADN10-24-1PM-C
480 W	85-264 Vac 90-375 Vac	20 A	4.85" x 3.42" x 4.96" (123 x 87 x 126)	2.60 lbs (1200 g)	ADN20-24-1PM-C

MicroTCA[®] Power Modules

MTC600 Series

600 Watts

Special Features

- 600 W output power
- 16 channels of
 - 12 V @ 7.6 A max
 - 3.3 V @ 150 mA max
- Supports:
 - 12x AMCs
 - 2x MCHs
 - 2x CUs
- Supports N+1 output redundancy, N ≤ 3
- Supports 1+1 input redundancy

Compliance

- PICMG[®] MicroTCA.0 (Revision 1.0)
- PICMG HPM.1 Firmware Upgrade (Revision 1.0)



Electrical Specifications

Input Single Phase		
-48 Vdc Models		
Input range (operating)	-39.5 to -72 Vdc	Supports -48 V and -60 V battery plants
Input range (non-operating)	0 to -39.5 Vdc -72 to -75 Vdc	Power Module may or may not operate in part of this range, but will not be damaged
Reverse polarity protection	Included	Protected against reverse polarity over magnitude of specified input range
AC Models		
Input range (operating)	90-264 Vac	Supports typical worldwide single-phase inputs
Input range (non-operating)	0-90 Vac 264-282 Vac	Power Module may or may not operate in part of this range, but will not be damaged
Power factor	0.99 typical	Meets EN61000-3-2
Output - All Models		
12 V Outputs (Payload Power)		
Setpoint	12.6 Vdc typical	Configured as Primary PM Configured as Redundant PM
Total regulation range	12.25-12.95 Vdc 11.60-12.00 Vdc	Configured as Primary PM Configured as Redundant PM
Rated load	600 W maximum 80 W/7.6 A maximum	Per power module, input voltage Per load channel
Minimum load	No load	No loss of regulation ≥ 110 Vrms
Output rise time (per channel)	25 ms maximum	With 1600 μF on output under test
Output noise (PARD)	75 mV maximum 100 mV maximum	0 to 30 MHz 0 to 100 MHz Measured with a 0.1 μF ceramic and 10 μF tantalum capacitor on any output and oscilloscope bandwidth set for 200 MHz

Electrical Specifications

Output - All Models (continued)		
3.3 V Outputs (Management Power)		
Setpoint	3.3 Vdc typical	
Total regulation range	3.16-3.63 Vdc	
Rated load	8 W maximum 0.5 W/150 mA maximum	Per power module Per load channel
Minimum load	No load	No loss of regulation \geq 110 Vrms
Output rise time (per channel)	25 ms maximum	With 150 μ F on output under test
Output noise (PARD)	50 mV maximum 75 mV maximum	0-30 MHz 0-100 MHz Measured with a 0.1 μ F ceramic and 10 μ F tantalum capacitor on any output
Transient response	3% maximum deviation 2 ms recovery time	37.5 mA loadstep @ 1 A/ μ s referenced to load current and setpoint at onset of transient. Recovery time to within 1% of setpoint at onset of transient

Temperature and Altitude Derating	
Condition	Temperature
Storage non-operating	-45 °C to -70 °C
Cold start	-20 °C to -5 °C
Normal operating	-5 °C to 45 °C
Short-term operating	45 °C to -70 °C
Category	Specifications
Conducted emissions	EN55022 Class A GR-1089-CORE
Radiated emissions	EN55022 Class A
Electrostatic discharge (ESD)	EN61000-4-2
Immunity to radiated fields	EN61000-4-3
Electrical fast transients (burst)	EN61000-4-4
Surge immunity	EN61000-4-5
Immunity to conducted noise	EN61000-4-6

Safety

UL, cUL	UL60950-1
CSA	60950-1
VDE	60950-1

Ordering Information

	Power Level	Input Voltage	Redundant	Channel Count	Width	Height	Reserved	
MTC	PPP	VV	RR	NN	W	H	XX	J
	600 = 600 W	48 = -48 Vdc AC = 90-264 Vac	RR = Redundant input and redundant output NR = Non-redundant input and redundant output	16 = 16 ch	S = Single width	9 = 9 HP 1 = 12 HP	For modified standards	



DC-DC Converters

Emerson Network Power is widely acknowledged as an industry leader in distributed power applications and produces an exceptionally wide range of DC-DC conversion products.



Distributed Power Architecture

Emerson Network Power understands the needs and nuances of developing power systems using a Distributed Power Architecture. We know it is your job to create the most efficient, cost-effective, quality system, and deliver it in a timely fashion.

From full-system power to board-level components, high-power isolated front ends to a full line of isolated and non-isolated DC-DC modules, Emerson Network Power is the source for today's power systems.

Distributed Power Architecture DC-DC Conversion

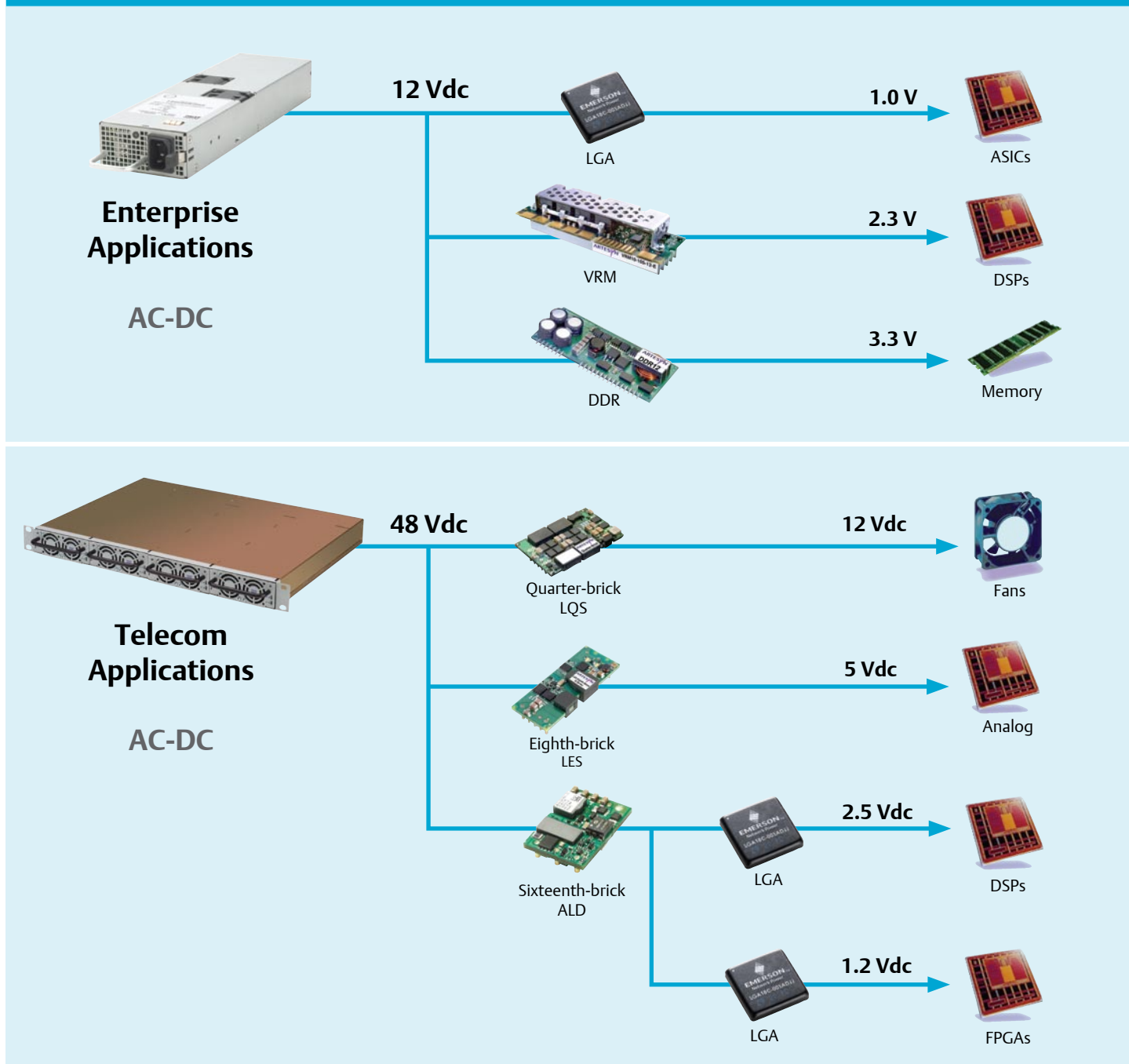

Advanced Telecommunications Computing Architecture (ATCA®)

210 Watt & 250 Watt Modules

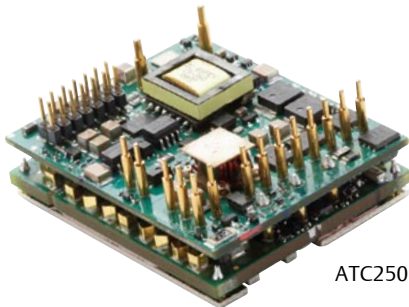

ATC250

Special Features

- Fully integrated input power module and intermediate bus converter solution for high density ATCA applications
- OR'ing for A/B dual 48 Vdc power feeds
- Hot swap capability with inrush protection
- EMI filtering
- Independent 50 V clamp output for charging external hold up capacitors (programmable to 80 V on ATC250)
- 12 V main output with 3.3 V power management supply
- Hardware alarms via opto-isolators for loss of A or B feeds
- I²C serial bus interface for monitoring and reporting
- Programmable alarm thresholds via I²C
- International safety standards approvals-UL, CSA, TÜV and CB report

Vout	Iout	Input Voltage	Package L x W x H (mm)	Efficiency	Model Number
12/3.3V	ATCA Open-frame				
	17.5/1.8 A	-48 V (-36 to -72 V)	2.32" x 1.81" x 0.83" (58.93 x 45.97 x 21.08)	89%	ATC210-48D12-03J
	20.83/4.5 A	-48 V (-36 to -72 V)	2.32" x 1.81" x 0.83" (58.93 x 45.97 x 21.08)	89%	ATC250-48D12-03J

ATCA Blades with Real Estate Constraints

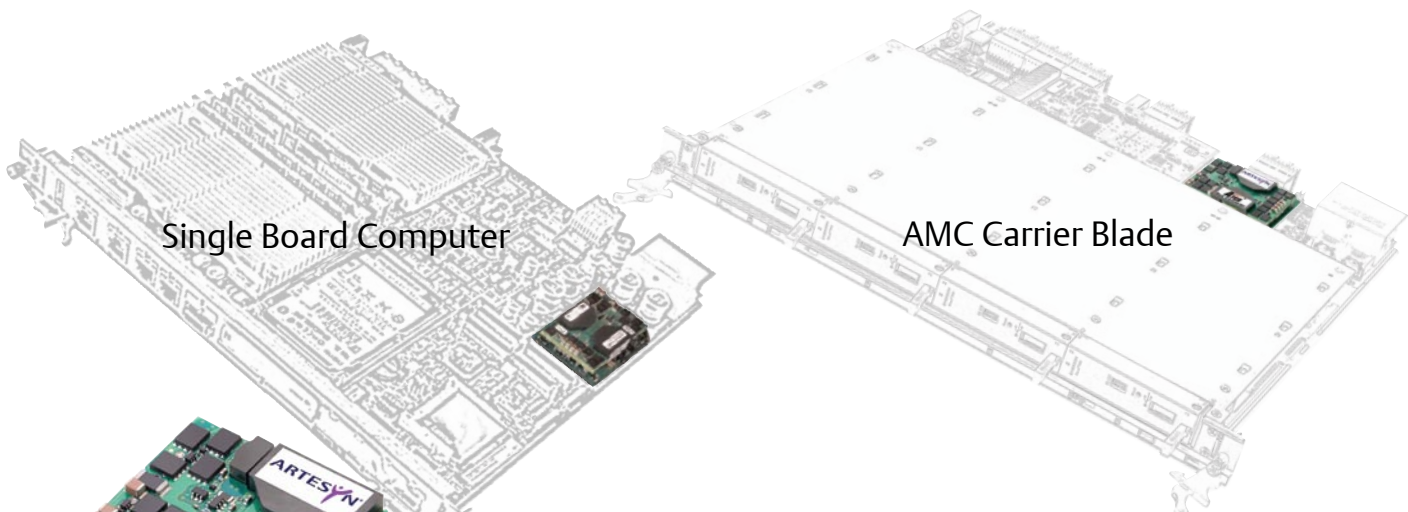

Single Board Computer

AMC Carrier Blade

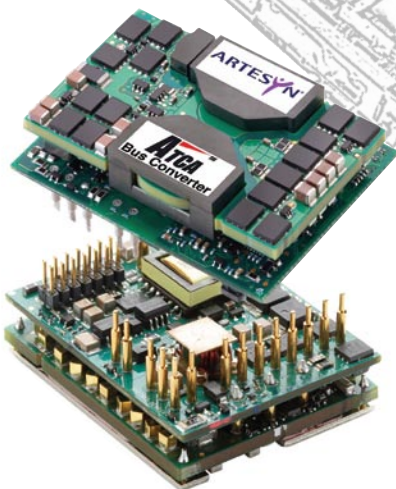

The ATC210 and ATC250 provides board designers with an easy to use fully-integrated power module for space-constrained blades and AMCs.

The ATC210 and ATC250 are fully-integrated modules that are more than just power converters. They also provide power interface and power management functionality. The power interface functions include OR'ing, filtering, inrush control and auxiliary 3.3 Vdc output, while power management

functionality is facilitated by both I²C serial bus and direct hardware alarms for loss of A or B -48 Vdc input feeds or open fuses. The ATC210 and ATC250 provide ATCA board designers with a compact and optimized solution for space-constrained blades and AMCs.

Sixteenth-Brick

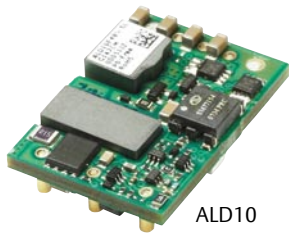

ALD10



ALD18F48

Special Features

- Industry leading: sixteenth-brick standard package and feature sets
- Scalable offering: 35 W and 60 W platforms
- Mechanical options for optimum mounting flexibility: Through-hole (default) or surface mount (suffix “-S”) termination; 5 mm (default) or 3.7 mm through-hole pin length option
- Meets basic insulation
- Power densities as high as 146.5 W per cubic inch
- International safety standards approvals – UL, CSA, TÜV

Vout	Iout	Input Voltage	Package L x W x H (mm)	Efficiency	Model Number
1.2 V	Open-frame				
	15 A	48 V (36-75 V)	1.3" x 0.9" x 0.35" (33 x 22.86 x 8.89)	84%	ALD15K48N-L
	25 A	48 V (36-75 V)	1.3" x 0.9" x 0.35" (33 x 22.86 x 8.89)	84%	ALD25K48N-L
1.5 V	Open-frame				
	15 A	48 V (36-75 V)	1.3" x 0.9" x 0.35" (33 x 22.86 x 8.89)	85%	ALD15M48N-L
	25 A	48 V (36-75 V)	1.3" x 0.9" x 0.35" (33 x 22.86 x 8.89)	85%	ALD25M48N-L
1.8 V	Open-frame				
	13 A	48 V (36-75 V)	1.3" x 0.9" x 0.35" (33 x 22.86 x 8.89)	87%	ALD13Y48N-L
	25 A	48 V (36-75 V)	1.3" x 0.9" x 0.35" (33 x 22.86 x 8.89)	88%	ALD25Y48N-L
2.5 V	Open-frame				
	11 A	48 V (36-75 V)	1.3" x 0.9" x 0.35" (33 x 22.86 x 8.89)	89%	ALD11G48N-L
	20 A	48 V (36-75 V)	1.3" x 0.9" x 0.35" (33 x 22.86 x 8.89)	89%	ALD20G48N-L
3.3 V	Open-frame				
	10 A	48 V (36-75 V)	1.3" x 0.9" x 0.35" (33 x 22.86 x 8.89)	90%	ALD10F48N-L
	18 A	48 V (36-75 V)	1.3" x 0.9" x 0.35" (33 x 22.86 x 8.89)	90%	ALD18F48N-L
5 V	Open-frame				
	7 A	48 V (36-75 V)	1.3" x 0.9" x 0.35" (33 x 22.86 x 8.89)	91%	ALD07A48N-L
	12 A	48 V (36-75 V)	1.3" x 0.9" x 0.35" (33 x 22.86 x 8.89)	91%	ALD12A48N-L
12 V	Open-frame				
	2.75 A	48 V (36-75 V)	1.3" x 0.9" x 0.35" (33 x 22.86 x 8.89)	92%	ALD03B48N-L

Footprint/Package Leverage

Common Features

- Open-frame or baseplate
- Through-hole or SMT
- 3.7 mm or 5 mm pin length
- Negative or Positive enable

Designing multiple footprints maximizes product availability (supply) and creates greatest cost/price leverage

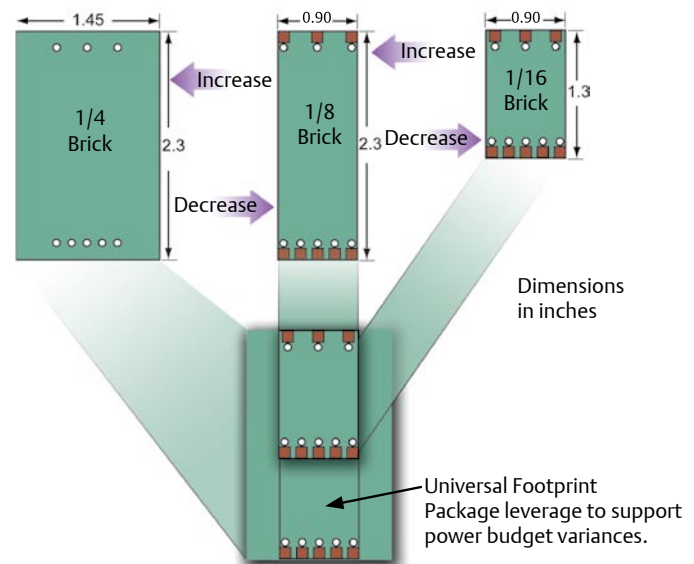

Eighth-Brick

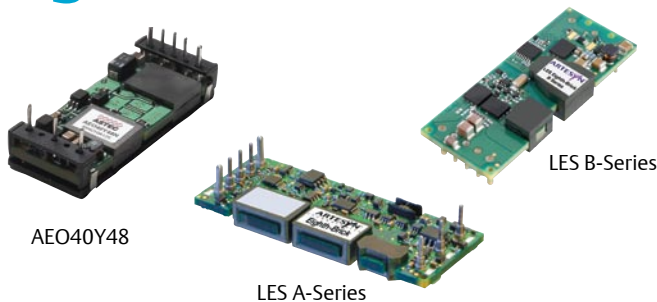

Special Features

- Industry leading: eighth-brick standard package and feature sets
- Scalable output power offering: Low power 80 W series or up to 120 W high power series
- Mechanical options for optimum mounting flexibility: Open-frame (ALO or LES) or baseplate (AEO) construction; Through-hole (default) or surface mount (suffix “-S”) termination; 5 mm (default) or 3.7 mm through-hole pin length option
- Meets basic insulation
- Power densities as high as 181 W per cubic inch
- Wide operating temperature range
- International safety standards approvals – UL, CSA, TÜV

Vout	Iout	Input Voltage	Package L x W x H (mm)	Efficiency	Model Number
1.0 V	Open-frame				
	25 A	48 V (36-75 V)	2.3" x 0.9" x 0.36" (58.42 x 22.86 x 9.14)	85%	LES25B48-1V0REJ
1.2 V	Open-frame				
	25 A	48 V (36-75 V)	2.3" x 0.9" x 0.36" (58.42 x 22.86 x 9.14)	86%	LES25B48-1V2REJ
	50 A	48 V (36-75 V)	2.3" x 0.9" x 0.34" (58.42 x 22.86 x 8.64)	86%	LES50A48-1V2REJ
	Baseplate				
	25 A	48 V (36-75 V)	2.3" x 0.9" x 0.4" (58.42 x 22.86 x 10.16)	85%	AEO25K48N-L
	40 A	48 V (36-75 V)	2.3" x 0.9" x 0.4" (58.42 x 22.86 x 10.16)	86%	AEO40K48N-L
1.5 V	Open-frame				
	25 A	48 V (36-75 V)	2.3" x 0.9" x 0.36" (58.42 x 22.86 x 9.14)	88%	LES25B48-1V5REJ
	40 A	48 V (36-75 V)	2.3" x 0.9" x 0.32" (58.42 x 22.86 x 8.13)	88%	ALO40M48N-L
	Baseplate				
	25 A	48 V (36-75 V)	2.3" x 0.9" x 0.4" (58.42 x 22.86 x 10.16)	86%	AEO25M48N-L
	40 A	48 V (36-75 V)	2.3" x 0.9" x 0.4" (58.42 x 22.86 x 10.16)	88%	AEO40M48N-L
1.8 V	Open-frame				
	20 A	24 V (18-36 V)	2.3" x 0.9" x 0.34" (58.42 x 22.86 x 8.64)	91%	LES20A24-1V8REJ
	25 A	48 V (36-75 V)	2.3" x 0.9" x 0.36" (58.42 x 22.86 x 9.14)	89%	LES25B48-1V8REJ
	40 A	48 V (36-75 V)	2.3" x 0.9" x 0.32" (58.42 x 22.86 x 8.13)	90%	ALO40Y48N-L
	Baseplate				
		25 A	48 V (36-75 V)	2.3" x 0.9" x 0.4" (58.42 x 22.86 x 10.16)	87%
	40 A	48 V (36-75 V)	2.3" x 0.9" x 0.4" (58.42 x 22.86 x 10.16)	90%	AEO40Y48N-L
2.5 V	Open-frame				
	22 A	48 V (36-75 V)	2.3" x 0.9" x 0.36" (58.42" x 22.86 x 9.14)	91%	LES22B48-2V5REJ
	40 A	48 V (36-75 V)	2.3" x 0.9" x 0.34" (58.42" x 22.86 x 8.64)	91%	LES40 A48-2V5REJ
	Baseplate				
		20 A	48 V (36-75 V)	2.3" x 0.9" x 0.4" (58.42 x 22.86 x 10.16)	90%
	35 A	48 V (36-75 V)	2.3" x 0.9" x 0.4" (58.42 x 22.86 x 10.16)	90%	AEO35G48N-L
3.3 V	Open-frame				
	20 A	24 V (18-36 V)	2.3" x 0.9" x 0.34" (58.42 x 22.86 x 8.64)	90%	LES20A24-3V3REJ
	20 A	24V/48 V (19-60 V)	2.3" x 0.9" x 0.32" (58.42 x 22.86 x 8.13)	91%	ALO20F36N-L
	20 A	48 V (36-75 V)	2.3" x 0.9" x 0.36" (58.42 x 22.86 x 9.14)	91%	LES20B48-3V3REJ
	30 A	48 V (36-75 V)	2.3" x 0.9" x 0.32" (58.42 x 22.86 x 8.13)	91%	ALO30F48N-L
	Baseplate				
		20 A	48 V (36-75 V)	2.3" x 0.9" x 0.4" (58.42 x 22.86 x 10.16)	91%
	30 A	48 V (36-75 V)	2.3" x 0.9" x 0.4" (58.42 x 22.86 x 10.16)	91%	AEO30F48N-L
5 V	Open-frame				
	13 A	48 V (36-75 V)	2.3" x 0.9" x 0.36" (58.42 x 22.86 x 9.14)	92%	LES13B48-5V0REJ
	20 A	48 V (36-75 V)	2.3" x 0.9" x 0.32" (58.42 x 22.86 x 8.13)	93%	ALO20A48N-L
	Baseplate				
	12 A	48 V (36-75 V)	2.3" x 0.9" x 0.4" (58.42 x 22.86 x 10.16)	93%	AEO12A48N-L
	20 A	48 V (36-75 V)	2.3" x 0.9" x 0.4" (58.42 x 22.86 x 10.16)	92%	AEO20A48N-L
12 V	Open-frame				
	6.7 A	48 V (36-75 V)	2.3" x 0.9" x 0.36" (58.42 x 22.86 x 9.14)	93%	LES06B48-12V0REJ
	10 A	48 V (36-75 V)	2.3" x 0.9" x 0.32" (58.42 x 22.86 x 8.13)	92%	ALO10B48N-L
	Baseplate				
	4 A	48 V (36-75 V)	2.3" x 0.9" x 0.4" (58.42 x 22.86 x 10.16)	93%	AEO04B48N-L
	10 A	48 V (36-75 V)	2.3" x 0.9" x 0.4" (58.42 x 22.86 x 10.16)	92%	AEO10B48N-L
15 V	Open-frame				
	5 A	24 V (18-36 V)	2.3" x 0.9" x 0.4" (58.42 x 22.86 x 10.16)	91%	LES05B24-15V0J

Quarter-Brick

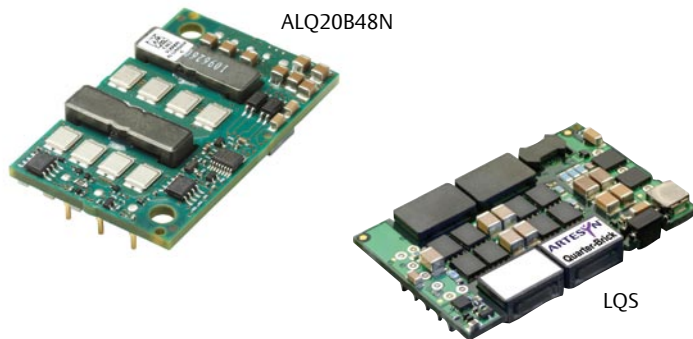

Special Features

- Industry leading: quarter-brick standard package and feature sets
- Up to 100 A offering
- Wide operating temperature range
- Meets basic insulation
- Exceptional dynamic response and reactive loading capability
- Monotonic start-up characteristic
- International safety standards approvals – UL, CSA, TÜV

Vout	Iout	Input Voltage	Package L x W x H (mm)	Efficiency	Model Number
1.2 V	Open-frame				
	50 A	48 V (36-75 V)	2.3" x 1.45" x 0.34" (58.42 x 36.83 x 8.64)	89%	LQS50A48-1V2REJ
	100 A	48 V (36-75 V)	2.3" x 1.45" x 0.34" (58.42 x 36.83 x 8.64)	86%	LQS100A48-1V2REJ
1.5 V	Open-frame				
	50 A	24 V (36-75 V)	2.3" x 1.45" x 0.34" (58.42 x 36.83 x 8.64)	89%	LQS50A48-1V5REJ
	80 A	48 V (36-75 V)	2.3" x 1.45" x 0.34" (58.42 x 36.83 x 8.64)	89%	LQS80A48-1V5REJ
1.8 V	Open-frame				
	30 A	24 V (18-36 V)	2.3" x 1.45" x 0.34" (57.42 x 36.83 x 8.64)	91%	LQS30A24-1V8REJ
	50 A	48 V (36-75 V)	2.3" x 1.45" x 0.34" (57.42 x 36.83 x 8.64)	90%	LQS50A48-1V8REJ
1.8 V	Open-frame				
	80 A	48 V (36-75 V)	2.3" x 1.45" x 0.34" (57.42 x 36.83 x 8.64)	90%	LQS80A48-1V8REJ
	100 A	48 V (36-75 V)	2.3" x 1.45" x 0.34" (57.42 x 36.83 x 8.64)	90%	LQS100A48-1V8REJ
1.8 V	Baseplate				
	75 A	48 V (36-75 V)	2.3" x 1.48" x 0.44" (58.42 x 37.59 x 11.18)	89%	AEQ75Y48N-3L
2.5 V	Open-frame				
	50 A	48 V (36-75 V)	2.3" x 1.45" x 0.34" (58.42 x 36.83 x 8.64)	90%	LQS50A48-2V5REJ
	80 A	48 V (36-75 V)	2.3" x 1.45" x 0.34" (58.42 x 36.83 x 8.64)	91%	LQS80A48-2V5REJ
3.3 V	Open-frame				
	30 A	24 V (18-36 V)	2.3" x 1.45" x 0.34" (58.42 x 36.83 x 8.64)	90%	LQS30A24-3V3REJ
	50 A	48 V (36-75 V)	2.3" x 1.45" x 0.34" (58.42 x 36.83 x 8.64)	91%	LQS50A48-3V3REJ
3.3 V	Open-frame				
	60 A	48 V (36-75 V)	2.3" x 1.45" x 0.34" (58.42 x 36.83 x 8.64)	91%	LQS60A48-3V3REJ
5 V	Open-frame				
	40 A	48 V (36-75 V)	2.3" x 1.45" x 0.34" (58.42 x 36.83 x 8.64)	92%	LQS40A48-5V0REJ
12 V	Open-frame				
	20 A	48 V (36-75 V)	2.3" x 1.45" x 0.36" (58.42 x 36.83 x 9.14)	93%	ALQ20B48N-L
	Baseplate				
20 A	48 V (36-75 V)	2.3" x 1.45" x 0.42" (58.42 x 36.83 x 10.67)	93%	AEQ20B48N-L	

Quarter-Brick Dual

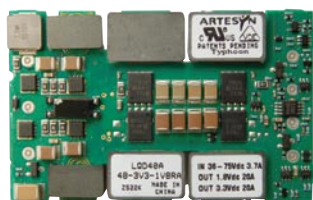

LQD40

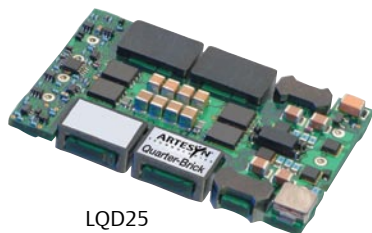

LQD25

Special Features

- Industry leading: quarter-brick standard package and feature sets
- Wide operating temperature range
- Independent control loop eliminates cross regulation
- Tightly regulated individual output channels
- Clean, fast transient load response
- International safety standards approvals – UL, CSA, TÜV

Vout	Iout	Input Voltage	Package L x W x H (mm)	Efficiency	Model Number
3.3 V/1.2 V	Open-frame				
	15/15 A	48 V (36-75 V)	2.3" x 1.45" x 0.34" (58.42 x 36.83 x 8.64)	90%	LQD30A48-3V31V2REJ
	20/20 A	48 V (36-75 V)	2.3" x 1.45" x 0.34" (58.42 x 36.83 x 8.64)	90%	LQD40A48-3V31V2REJ
3.3 V/1.5 V	Open-frame				
	15/15 A	48 V (36-75 V)	2.3" x 1.45" x 0.34" (58.42 x 36.83 x 8.64)	91%	LQD30A48-3V31V5REJ
	20/20 A	48 V (36-75 V)	2.3" x 1.45" x 0.34" (58.42 x 36.83 x 8.64)	91%	LQD40A48-3V31V5REJ
3.3 V/1.8 V	Open-frame				
	15/15 A	48 V (36-75 V)	2.3" x 1.45" x 0.34" (58.42 x 36.83 x 8.64)	91%	LQD30A48-3V31V8REJ
	20/20 A	48 V (36-75 V)	2.3" x 1.45" x 0.34" (58.42 x 36.83 x 8.64)	91%	LQD40A48-3V31V8REJ
3.3 V/2.5 V	Open-frame				
	15/15 A	48 V (36-75 V)	2.3" x 1.45" x 0.34" (58.42 x 36.83 x 8.64)	91%	LQD30A48-3V32V5REJ
	20/20 A	48 V (36-75 V)	2.3" x 1.45" x 0.34" (58.42 x 36.83 x 8.64)	91%	LQD40A48-3V32V5REJ
	Baseplate				
	12/16 A	48 V (36-75 V)	2.3" x 1.5" x 0.5" (58.42 x 38.10 x 12.7)	91%	EXQ60-48D3V3-2V5RJ
5 V/3.3 V	Open-frame				
	10/15 A	48 V (36-75 V)	2.3" x 1.45" x 0.34" (58.42 x 36.83 x 8.64)	91%	LQD25A48-5V03V3REJ



Half-Brick



EXB250



AEH80

Special Features

- Industry standard half-brick available up to 80 A
- Open-frame and baseplate construction
- Open-frame has heat sink adapter for conductive cooling applications
- Highest efficiencies available
- Optimum transient load performance and reactive loading capacity
- Wide operating temperature range
- International safety standards approvals – UL, CSA, TÜV

Vout	Iout	Input Voltage	Package L x W x H (mm)	Efficiency	Model Number
1.2 V	Open-frame				
	60 A	48 V (36-75 V)	2.4" x 2.3" x 0.42" (60.96 x 58.42 x 10.67)	86%	ALH60K48N-L
	80 A	48 V (36-75 V)	2.4" x 2.3" x 0.42" (60.96 x 58.42 x 10.67)	83%	ALH80K48N-3L
	Baseplate				
	60 A	48 V (33-75 V)	2.4" x 2.28" x 0.5" (60.96 x 57.91 x 12.7)	85%	EXB250-48S1V2-RJ
	80 A	48 V (36-75 V)	2.4" x 2.3" x 0.5" (60.96 x 58.42 x 12.7)	83%	AEH80K48N-3L
1.5 V	Open-frame				
	80 A	48 V (36-75 V)	2.3" x 2.4" x 0.4" (58.42 x 60.96 x 10.16)	86%	ALH80M48N-3L
	Baseplate				
	60 A	48 V (33-75 V)	2.4" x 2.28" x 0.5" (60.89 x 57.91 x 12.7)	86%	EXB250-48S1V5-RJ
	80 A	48 V (36-75 V)	2.3" x 2.4" x 0.5" (58.42 x 60.96 x 12.7)	86%	AEH80M48N-3L
	1.8 V	Open-frame			
60 A		48 V (36-75 V)	2.4" x 2.3" x 0.42" (60.96 x 58.42 x 10.67)	89%	ALH60Y48N-L
60 A		48 V (36-75 V)	2.4" x 2.3" x 0.42" (60.96 x 58.42 x 10.67)	87%	ALH80Y48N-3L
Baseplate					
60 A		48 V (33-75 V)	2.4" x 2.28" x 0.5" (60.96 x 57.91 x 12.7)	87%	EXB250-48S1V8-R
80 A		48 V (36-75 V)	2.4" x 2.3" x 0.5" (60.96 x 58.42 x 12.7)	87%	AEH80Y48N-3L
2.5 V	Open-frame				
	60 A	48 V (36-75 V)	2.4" x 2.3" x 0.42" (60.96 x 58.42 x 10.67)	90%	ALH60G48N-L
	Baseplate				
	60 A	48 V (33-75 V)	2.4" x 2.28" x 0.5" (60.96 x 57.91 x 12.7)	88%	EXB250-48S2V5-RJ
3.3 V	Open-frame				
	8 A	48 V (36-75 V)	2.4" x 2.28" x 0.43" (60.96 x 57.91 x 10.92)	90%	EXB30-48S3V3J
	10 A	48 V (36-75 V)	2.4" x 2.28" x 0.43" (60.96 x 57.91 x 10.92)	90%	EXB50-48S3V3J
	30 A	48 V (36-75 V)	2.4" x 2.28" x 0.39" (60.96 x 57.91 x 9.91)	91%	EXB100-48S3V3-RJ
	60 A	48 V (36-75 V)	2.4" x 2.3" x 0.42" (60.96 x 58.42 x 10.67)	91%	ALH60F48N-L
	Baseplate				
	30 A	24 V (18-36 V)	2.4" x 2.3" x 0.5" (60.96 x 57.91 x 12.7)	77%	BXB150-24S3V3FLTJ
	50 A	48 V (33-75 V)	2.4" x 2.3" x 0.5" (60.96 x 57.91 x 12.7)	90%	EXB250-48S3V3-RJ
	60 A	48 V (36-75 V)	2.4" x 2.3" x 0.5" (60.96 x 58.42 x 12.7)	91%	AEH60F48N-L
	5 V	Open-frame			
10 A		48 V (36-75 V)	2.4" x 2.28" x 0.43" (60.96 x 57.91 x 10.92)	91%	EXB50-48S05-RJ
20 A		48 V (36-75 V)	2.4" x 2.28" x 0.39" (60.96 x 57.91 x 9.91)	92%	EXB100-48S05-RJ
Baseplate					
33 A	48 V (33-75 V)	2.4" x 2.28" x 0.5" (60.96 x 57.91 x 12.7)	92%	EXB250-48S05-RJ	
12 V	Open-frame				
	2.5 A	48 V (36-75 V)	2.4" x 2.28" x 0.43" (60.96 x 57.91 x 10.92)	90%	EXB30-48S12J
	4.2 A	48 V (36-75 V)	2.4" x 2.28" x 0.43" (60.96 x 57.91 x 10.92)	90%	EXB50-48S12J
	Baseplate				
	8.33 A	24 V (18-36 V)	2.4" x 2.28" x 0.5" (60.96 x 57.91 x 12.7)	85%	BXB100-24S12FLTJ
	13.75 A	48 V (33-75 V)	2.4" x 2.28" x 0.5" (60.96 x 57.91 x 12.7)	92%	EXB250-48S12-RJ
	25 A	48 V (36-75 V)	2.4" x 2.30" x 0.5" (60.96 x 58.42 x 12.7)	94%	AEH25B48N-CL
29.17 A	48 V (36-75 V)	2.4" x 2.30" x 0.5" (60.96 x 58.42 x 12.7)	94%	AEH30B48N-L	
15 V	Baseplate				
	8.33 A	24 V (18-36 V)	2.4" x 2.28" x 0.5" (60.96 x 57.91 x 12.7)	83%	BXB50-24S15FLTJ
52 V	Baseplate				
	7.55 A	48 V (38-60 V)	2.4" x 2.28" x 0.5" (60.96 x 57.91 x 12.7)	93%	AEH08U48N-L

Half-Brick Dual

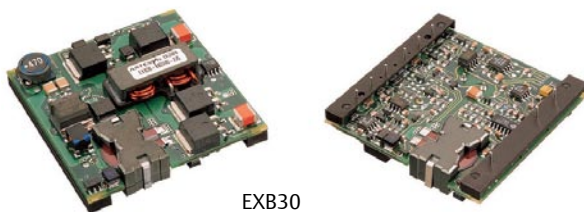

EXB30

	Current	Input Voltage	Package L x W x H (mm)	Efficiency	Model Number
1.8/3.3 V	Open-frame				
	8.5/8.5 A	48 V (36-75 V)	2.4" x 2.28" x 0.39" (60.96 x 57.91 x 9.91)	86%	EXB50-48D3V3-1V8J
3.3/5 V	Open-frame				
	6/6 A	24 V (18-36 V)	2.4" x 2.28" x 0.5" (60.96 x 57.91 x 12.7)	87%	EXB30-24D05-3V3J
	6/6 A	48 V (36-75 V)	2.4" x 2.28" x 0.5" (60.96 x 57.91 x 12.)	88%	EXB30-48D05-3V3J
	7.5/7.5 A	48 V (36-75 V)	2.4" x 2.28" x 0.39" (60.96 x 57.91 x 9.91)	89%	EXB50-48D05-3V3-RJ

RF Power Bricks



RFF700



RFB300

Special Features

- Specialized high power bricks for RF applications such as base station power amplifiers
- Offered in 24 V and 48 V input voltages
- Wide output voltage adjustability
- -40 °C to 100 °C baseplate temperature with no derating at rated power
- International safety standard approvals – UL, CSA, VDE, CB Report

Half-Brick

Vout	Iout	Input Voltage	Package L x W x H (mm)	Efficiency	Model Number
7.2-13.2 V	Baseplate				
	25 A	24 V (18-36 V)	2.4" x 2.27" x 0.5" (60.96 x 57.66 x 12.7)	86%	RFB300-24S12-R5Y
	29.2 A	48 V (36-75 V)	2.4" x 2.27" x 0.5" (60.96 x 57.66 x 12.7)	86%	RFB350-48S12-R5J
16.8-29.4 V	Baseplate				
	11 A	24 V (18-36 V)	2.4" x 2.27" x 0.5" (60.96 x 57.66 x 12.7)	90%	RFB300-24S28-R5Y
	11 A	48 V (36-75 V)	2.4" x 2.27" x 0.5" (60.96 x 57.66 x 12.7)	91%	RFB300-48S28-R5J
	12.5 A	48 V (36-75 V)	2.4" x 2.27" x 0.5" (60.96 x 57.66 x 12.7)	91%	RFB350-48S28-R5Y

Full-Brick

Vout	Iout	Input Voltage	Package L x W x H (mm)	Efficiency	Model Number
16.8-29.4 V	Baseplate				
	17.9 A	24 V (18-36 V)	4.6" x 2.4" x 0.5" (116.84 x 60.96 x 12.7)	90%	RFF500-24S28-5Y
	17.9 A	48 V (36-75 V)	4.6" x 2.4" x 0.5" (116.84 x 60.96 x 12.7)	91%	RFF500-48S28-5Y
	21.4 A	24 V (18-36 V)	4.6" x 2.4" x 0.5" (116.84 x 60.96 x 12.7)	90%	RFF600-24S28-5Y
	21.4 A	48 V (36-75 V)	4.6" x 2.4" x 0.5" (116.84 x 60.96 x 12.7)	91%	RFF600-48S28-5Y
	25 A	48 V (36-75 V)	4.6" x 2.4" x 0.5" (116.84 x 60.96 x 12.7)	91%	RFF700-48S28-5Y

Bus Converters

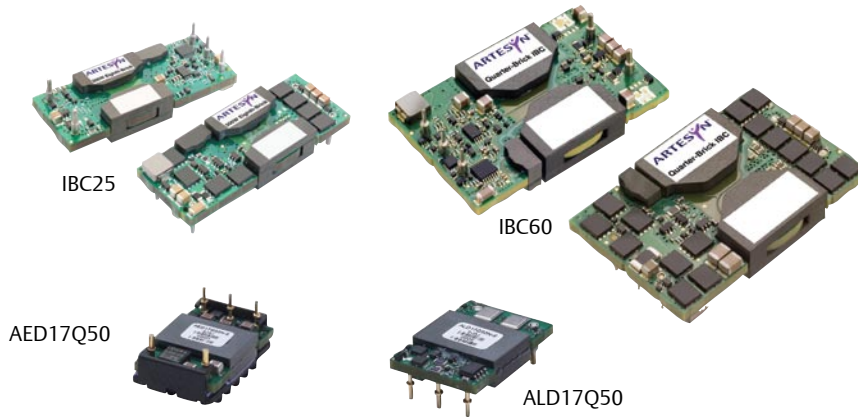

Special Features

- Industry standard footprints
- Wide operating temperature range
-40 °C to 100 °C case (baseplate)
-40 °C to 85 °C ambient (open-frame)
- Rich feature sets: overvoltage, over temperature protection, on/off enable
- Meets basic insulation
- Wide or narrow input voltage range, open loop or semi-regulated output for telecom and enterprise applications
- International safety standard approvals – UL, CSA, VDE, CB Report

Sixteenth-Brick

Vout	Iout	Input Voltage	Package L x W x H (mm)	Efficiency	Model Number
9.6 V	Open-frame				
	17 A	48 V (38-55 V)	1.3" x 0.9" x 0.35" (33.02 x 22.86 x 8.89)	96%	ALD17Q50N-L
	17 A	48 V (38-60 V)	1.3" x 0.9" x 0.35" (33.02 x 22.86 x 8.89)	95%	ALD17Q60N-L
	Baseplate				
	17 A	48 V (38-55 V)	1.4" x 0.9" x 0.35" (35.56 x 22.86 x 8.89)	96%	AED17Q50N-L
12 V	Open-frame				
	13 A	48 V (38-60 V)	1.3" x 0.9" x 0.35" (33.02 x 22.86 x 8.89)	96%	ALD13B50N-L
	Baseplate				
	13 A	48 V (38-60 V)	1.4" x 0.9" x 0.35" (35.56 x 22.86 x 8.89)	96%	AED13B50N-L

Eighth-Brick

Vout	Iout	Input Voltage	Package L x W x H (mm)	Efficiency	Model Number
9.6 V	Open-frame				
	32 A	48 V (38-55 V)	2.3" x 0.9" x 0.48" (58.42 x 22.86 x 12.19)	97%	IBC32AEN4896-REJ
12 V	Open-frame				
	17 A	48 V (36-75 V)	2.3" x 0.9" x 0.45" (58.42 x 22.86 x 11.43)	94%	IBC17AEW4812-REJ
	20 A	48 V (42-53 V)	2.3" x 0.9" x 0.45" (58.42 x 22.86 x 11.43)	95%	IBC20AES4812-REJ
	25 A	48 V (42-53 V)	2.3" x 0.9" x 0.45" (58.42 x 22.86 x 11.43)	96%	IBC25AET4812-REJ

Quarter-Brick

Vout	Iout	Input Voltage	Package L x W x H (mm)	Efficiency	Model Number
9.6 V	Open-frame				
	60 A	48 V (38-55 V)	2.3" x 1.45" x 0.48" (58.42 x 36.83 x 12.19)	97%	IBC60AQN4896-REJ
12 V	Open-frame				
	28 A	48 V (36-75 V)	2.3" x 1.45" x 0.45" (58.42 x 36.83 x 11.43)	95%	IBC28AQW4812-REJ
	30 A	48 V (42-53 V)	2.3" x 1.45" x 0.45" (58.42 x 36.83 x 11.43)	95%	IBC30AQS4812-REJ
	37.5 A	48 V (42-53 V)	2.3" x 1.45" x 0.45" (58.42 x 36.83 x 11.43)	96%	IBC38AQT4812-REJ
	42 A	48 V (36-55 V)	2.3" x 1.48" x 0.45" (58.42 x 36.59 x 11.43)	97%	ALQ42B50N-L
	Baseplate				
	42 A	48 V (36-55 V)	2.3" x 1.48" x 0.52" (58.42 x 36.59 x 13.21)	97%	AEQ42B50N-L

C-Class – Economy

The 1st generation C-Class non-isolated DC–DC converters are designed to provide good efficiency and performance.



SIL20C

SMT30C

SMT40C

SMT06C

Special Features

- Input voltage ranges: 4.5-5.5 V or 10.2-13.8 V
- Wide output voltage trim/adjustability: 0.9 to 5 Vdc
- Output current: 6-40 A
- High efficiency up to 92%
- Remote on/off
- Power good
- Parallel operation/current share (SIL30C and SIL40C)
- Remote sense (SIL30C and SIL40C)
- Excellent transient response
- Operating temperature range for SIL20C2 and SIL40C2: 0 °C to 70 °C
- Protection: overcurrent/short-circuit
- Cost-optimized design – industry leading value
- Compact footprint, vertical, horizontal and horizontal SMT options
- International safety standard approvals – UL, CSA, TÜV & CB Report

General-Purpose C-Class Non-Isolated DC–DC Converters

Output Current	Input Voltage	Output Voltage	Efficiency	Package L x W x H (mm)	Model Number
Single-In-Line, Through-hole Mounting					
6 A	4.5-5.5 Vdc	0.9-3.3 V	89%	1.2" x 0.45" x 0.61" (30.48 x 11.43 x 15.49)	SIL06C-05SADJ-VJ
6 A	10.2-13.8 Vdc	0.9-5.0 V	91%	1.2" x 0.45" x 0.61" (30.48 x 11.43 x 15.49)	SIL06C-12SADJ-VJ
15 A	4.5-5.5 Vdc	0.9-3.3 V	89%	1.2" x 0.4" x 1.1" (30.48 x 10.16 x 27.94)	SIL15C-05SADJ-VJ
15 A	10.2-13.8 Vdc	0.9-5.0 V	91%	1.2" x 0.4" x 1.1" (30.48 x 10.16 x 27.94)	SIL15C-12SADJ-VJ
20 A	4.5-5.5 Vdc	0.9-3.3 V	87%	1.2" x 0.45" x 1.1" (30.48 x 10.16 x 27.94)	SIL20C-05SADJ-VJ
20 A	10.2-13.8 Vdc	0.9-5.0 V	91%	1.2" x 0.45" x 1.1" (30.48 x 10.16 x 27.94)	SIL20C-12SADJ-VJ
25 A	10.2-13.8 Vdc	-4.5-(-5.5 V)	90%	2.4" x 0.52" x 1.25" (60.96 x 13.21 x 31.75)	SIL25C-12SNEG-VJ
30 A	10.2-13.8 Vdc	0.9-5.0 V	91%	2.4" x 0.52" x 1.25" (60.96 x 13.21 x 31.75)	SIL30C-12SADJ-VJ
40 A	10.2-13.8 Vdc	0.9-5.0 V	92%	2.4" x 0.52" x 1.25" (60.96 x 13.21 x 31.75)	SIL40C-12SADJ-VJ
Surface-Mounting					
6 A	4.5-5.5 Vdc	0.9-3.3 V	89%	1.2" x 0.53" x 0.47" (30.48 x 13.46 x 11.94)	SMT06C-05SADJJ
6 A	10.2-13.8 Vdc	0.9-5.0 V	91%	1.2" x 0.53" x 0.47" (30.48 x 13.46 x 11.94)	SMT06C-12SADJJ
15 A	4.5-5.5 Vdc	0.9-3.3 V	89%	1.2" x 1.1" x 0.46" (30.48 x 27.94 x 11.68)	SMT15C-05SADJJ
15 A	10.2-13.8 Vdc	0.9-5.0 V	91%	1.2" x 1.1" x 0.46" (30.48 x 27.94 x 11.68)	SMT15C-12SADJJ
20 A	4.5-5.5 Vdc	0.9-3.3 V	87%	1.2" x 1.14" x 0.46" (30.48 x 28.96 x 11.68)	SMT20C-05SADJJ
20 A	10.2-13.8 Vdc	0.9-5.0 V	91%	1.2" x 1.14" x 0.46" (30.48 x 28.96 x 11.68)	SMT20C-12SADJJ
30 A	10.2-13.8 Vdc	0.9-5.0 V	91%	2.28" x 1.45" x 0.43" (57.91 x 36.83 x 10.92)	SMT30C-12SADJJ
40 A	10.2-13.8 Vdc	0.9-5.0 V	92%	2.28" x 1.45" x 0.43" (57.91 x 36.83 x 10.92)	SMT40C-12SADJJ

C-Class – High Density

The 2nd generation C-Class non-isolated DC–DC converters are designed to provide good efficiency and performance, a smaller footprint, and integrated input and output capacitors.



LDO03C

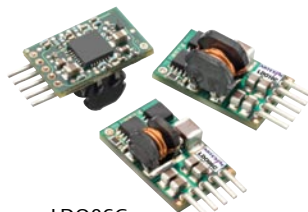

LDO06C

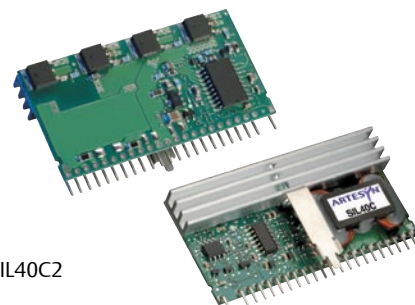

SIL40C2

Special Features

- Wide input voltage ranges: 3-13.8 V or 4.5-13.8 V
- Wide output voltage trim/adjustability: 0.59-5.1 V
- Output current: 3-40 A
- High efficiency up to 94%
- Remote on/off
- Power good
- Remote sense (Sxx20C2 and Sxx40C2)
- Excellent transient response
- Current sink capability for termination applications
- Operating temperature range for LDO03, LDO06 and LDO10: -40 °C to 70 °C
- Operating temperature range: 0 °C to 70 °C
- Protection: over current/short-circuit
- No added input or output capacitors needed for ripple current capability or stability
- Cost-optimized design – industry leading value
- Compact footprint, vertical, horizontal and horizontal SMT options
- International safety standard approvals – UL, CSA, TÜV & CB Report

General-Purpose C-Class Non-Isolated DC–DC Converters

Output Current	Input Voltage	Output Voltage	Efficiency	Package L x W x H (mm)	Model Number
Single-In-Line, Through-hole Mounting					
3 A	3.0-13.8 Vdc	0.59-5.1 V	90%	0.37" x 0.21" x 0.61" (9.4 x 5.33 x 15.49)	LDO03C-005W05-VJ
6 A	3.0-13.8 Vdc	0.59-5.1 V	92%	0.41" x 0.37" x 0.65" (10.41 x 9.4 x 16.51)	LDO06C-005W05-VJ
10 A	3.0-13.8 Vdc	0.59-5.1 V	94%	0.41" x 0.45" x 0.65" (10.41 x 11.43 x 16.51)	LDO10C-005W05-VJ
20 A	4.5-13.8 Vdc	0.59-5.1 V	93%	1.2" x 0.46" x 0.61" (30.48 x 11.68 x 15.49)	SIL20C2-00SADJ-VJ
40 A	4.5-13.8 Vdc	0.6-5.0 V	94%	1.2" x 0.43" x 1.1" (30.48 x 10.92 x 27.94)	SIL40C2-00SADJ-VJ
Surface-Mounting					
3 A	3.0-13.8 Vdc	0.59-5.1 V	90%	0.61" x 0.37" x 0.29" (15.49 x 9.4 x 7.37)	LDO03C-005W05-SJ
6 A	3.0-13.8 Vdc	0.59-5.1 V	92%	0.65" x 0.41" x 0.44" (16.51 x 10.41 x 11.18)	LDO06C-005W05-SJ
10 A	3.0-13.8 Vdc	0.59-5.1 V	94%	0.65" x 0.41" x 0.52" (16.51 x 10.41 x 13.21)	LDO10C-005W05-SJ
20 A	4.5-13.8 Vdc	0.59-5.1 V	93%	1.2" x 0.61" x 0.48" (30.48 x 15.49 x 12.19)	SMT20C2-00SADJJ
40 A	4.5-13.8 Vdc	0.6-5.0 V	94%	1.2" x 1.1" x 0.44" (30.48 x 27.94 x 11.18)	SMT40C2-00SADJJ

C-Class – High Density LGA C Series

The latest addition to the C-Class non-isolated DC-DC converter offering packaged in an ultra-compact, low-profile Land Grid Array with current densities up to 225 A/in³.

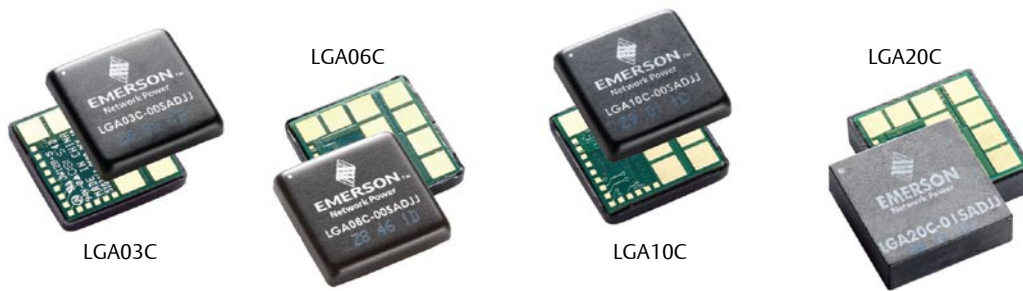

Special Features

- High density, ultra low profile surface mount module in Land Grid Array (LGA) package
- Available in 4 different output current levels: 3, 6, 10 and 20 Amps
- Wide input voltage range: 3.0-14.0 V
- Adjustable output voltage: 0.59-5.1 V via external resistor
- High efficiency ~92% typical
- Wide ambient operating temperature range: -40 °C to 85 °C
- Input UVLO; Remote On/Off; Output Adjust; Margin; PGood signal, Differential sense
- Current sink capability for voltage termination applications
- Integrated input and output capacitors resulting to minimal external capacitance required for stable operation

LGA C Series Non-Isolated DC-DC Converters

Output Current	Input Voltage	Output Voltage	Efficiency	Package L x W x H (mm)	Model Number
Surface-Mounting					
3 A	3.0-14 Vdc	0.59-5.1 V	92%	0.65" x 0.65" x 0.129" (16.51 x 16.51 x 3.27)	LGA03C-00SADJJ
6 A	3.0-14 Vdc	0.59-5.1 V	92%	0.65" x 0.65" x 0.129" (16.51 x 16.51 x 3.27)	LGA06C-00SADJJ
10 A	3.0-14 Vdc	0.59-5.1 V	92%	0.65" x 0.65" x 0.129" (16.51 x 16.51 x 3.27)	LGA10C-00SADJJ
20 A	4.5-14 Vdc	0.59-5.1 V	91%	0.65" x 0.65" x 0.210" (16.51 x 16.51 x 5.33)	LGA20C-01SADJJ

Note: Optional heatsink kits are available. Ordering part number is LGA-HTSK-KIT-XXX
 XXX = Total height of the LGA20C-01SADJJ with heatsink attached: 045 = 0.45"; 048 = 0.48"; 050 = 0.50"

A Paradigm Shift in Converter Packaging

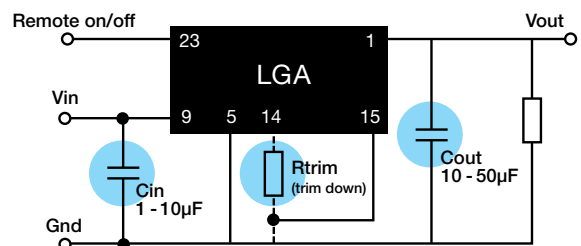
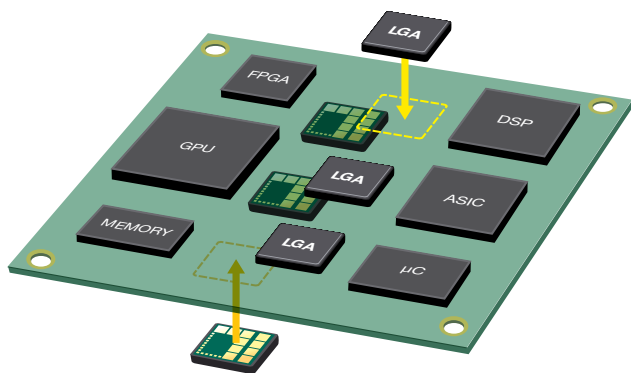

- Compact LGA package - significant improvement in current density, saves board space
- Allows for bilateral thermal management not easily provided by "down" solutions or typical modules (e.g., uniform height for coldplate cooling)
- Scalable solution, one footprint design for 3, 6, 10 and 20 A offering

- Fully operational DC-DC solution with 3 external components

E-Class – Performance

Efficiencies as high as 96% and current densities up to 140 A/in³.

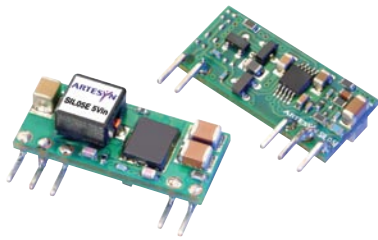

SILO5E



APA18

Special Features

Efficiencies as high as 96% and current densities up to 140 A/in³.

- Input voltage ranges: 3-5.5 V, 4.5-5.5 V, 8-14 V, 10-14 V
- Wide output voltage trim ranges: 0.8-3.63 V and 0.75-5.5 V
- Output current: 5-30 A
- Remote on/off
- Remote sense
- Industry standard footprint—vertical and horizontal mounting (low profile SMT/SIP—through-hole)
- Operating temperature range: -40 °C to 85 °C
- Built-in I²C bus interface feature for precision setting of both output voltage and voltage margining product series (SIL15E-12M)
- Protection: overcurrent/short-circuit
- International safety standard approvals –UL, CSA, TÜV & CB Report

General-Purpose E-Class Non-Isolated DC–DC Converters

Output Current	Input Voltage	Output Voltage	Efficiency	Package L x W x H (mm)	Model Number
Single-In-Line, Through-hole Mounting					
5 A	3.0-5.5 Vdc	0.75-3.63 V	94%	0.9" x 0.28" x 0.4" (22.86 x 7.11 x 10.16)	SIL05E-05W3V3-VJ
10 A	4.5-5.5 Vdc	0.8-3.63 V	95%	2" x 0.31" x 0.5" (50.8 x 7.87 x 12.7)	SIL10E-05W3V3-VJ
10 A	10-14 Vdc	0.8-3.63 V	94%	2" x 0.31" x 0.5" (50.8 x 7.87 x 12.7)	SIL10E-12W3V3-VJ
15 A	3.0-5.5 Vdc	0.8-3.63 V	94%	2" x 0.31" x 0.5" (50.8 x 7.87 x 12.7)	SIL15E-05W3V3-VJ
15 A	10-14 Vdc	0.8-3.63 V	94%	2" x 0.31" x 0.5" (50.8 x 7.87 x 12.7)	SIL15E-12W3V3-VJ
18 A	3.0-5.5 Vdc	0.75-3.6 V	92%	2" x 0.39" x 0.5" (50.8 x 9.91 x 12.7)	APA18T04-9L
18 A	10-14 Vdc	0.75-3.6 V	92%	2" x 0.39" x 0.5" (50.8 x 9.91 x 12.7)	APA18T12-9L
30 A	8.0-14 Vdc	0.8-3.63 V	93%	2" x 0.31" x 0.5" (50.8 x 7.87 x 12.7)	SIL30E-12W3V3-VJ
Surface-Mounting					
5 A	3.0-5.5 Vdc	0.75-3.63 V	94%	0.8" x 0.45" x 0.26" (20.32 x 11.43 x 6.6)	SMT05E-05W3V3J
5 A	10-14 Vdc	0.8-3.63 V	91%	0.8" x 0.45" x 0.24" (20.32 x 11.43 x 6.1)	SMT05E-12W3V3J
10 A	3.0-5.5 Vdc	0.8-3.63 V	96%	1.3" x 0.53" x 0.32" (33.02 x 13.46 x 8.13)	SMT10E-05W3V3J
10 A	10-14 Vdc	0.8-3.63 V	94%	1.3" x 0.53" x 0.32" (33.02 x 13.46 x 8.13)	SMT10E-12W3V3J
15 A	3.0-5.5 Vdc	0.8-3.63 V	95%	1.3" x 0.53" x 0.32" (33.02 x 13.46 x 8.13)	SMT15E-05W3V3J
15 A	10-14 Vdc	0.8-3.63 V	94%	1.3" x 0.53" x 0.32" (33.02 x 13.46 x 8.13)	SMT15E-12W3V3J
18 A	3.0-5.5 Vdc	0.75-3.63 V	92%	1.3" x 0.53" x 0.34 (33.02 x 13.46 x 8.64)	APC18T04-9L
18 A	10-14 Vdc	0.75-5.5 V	92%	1.3" x 0.53" x 0.34 (33.02 x 13.46 x 8.64)	APC18T12-9L
30 A	8.0-14 Vdc	0.8-3.63 V	91%	1.3" x 0.53" x 0.32" (33.02 x 13.46 x 8.13)	SMT30E-12W3V3J

F-Class – Fast Transient Response

Highly integrated non-isolated DC–DC modules, combining transient response up to 300 A/ μ s. Expressly designed to minimize the number of external capacitors needed.

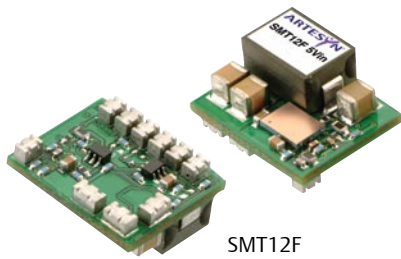

SMT12F

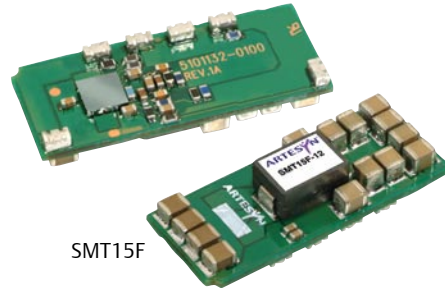

SMT15F

Special Features

- Input voltage ranges: 3-5.5 Vdc, 10.8-13.2 Vdc
- Wide output voltage trim range: 0.9-3.3 V (SMT12F)
- Output current: 12-15 A
- High efficiency: 95% @ 5 V in 3.3 Vdc output/full load
- Remote on/off
- Differential remote sense
- Power good
- Separate digital inputs for +5% and -5% output voltage margining
- Industry standard surface-mount footprint (SMT15F)
- Current densities in excess of 72 A/in³
- Operating temperature range: -40 °C to 85 °C
- Protection: overcurrent/short-circuit (non-latching) and overtemperature
- International safety standard approvals – UL, CSA, TÜV & CB Report

General-Purpose F-Class Non-Isolated DC–DC Converters

Output Current	Input Voltage	Output Voltage	Efficiency	Package L x W x H (mm)	Model Number
Surface-Mounting					
12 A	3-5.5 Vdc	0.9-3.3 V	95%	0.63" x 0.52" x 0.31" (16 x 13.21 x 7.87)	SMT12F-05W3V3J
15 A	10.8-13.2 Vdc	1.0 V	85%	1.3" x 0.53" x 0.3" (33.02 x 13.46 x 7.62)	SMT15F-12S1V0J
15 A	10.8-13.2 Vdc	1.2 V	86%	1.3" x 0.53" x 0.3" (33.02 x 13.46 x 7.62)	SMT15F-12S1V2J
15 A	10.8-13.2 Vdc	1.5 V	87%	1.3" x 0.53" x 0.3" (33.02 x 13.46 x 7.62)	SMT15F-12S1V5J
15 A	10.8-13.2 Vdc	1.8 V	88%	1.3" x 0.53" x 0.3" (33.02 x 13.46 x 7.62)	SMT15F-12S1V8J



POLA-DDR/Memory

Choose POLA modules for multi-sourced and interoperable parts.



PTH12060Y



PTH12010Y



PTH05050Y

Special Features

- Input voltage ranges: 2.95-3.65 V , 4.5-5.5 V, 10.8-13.2 V
- Wide VTT output voltage trim/adjustability: 0.55-1.8 V
- Output current: 6-15 A
- High efficiency up to 88%
- VTT bus termination output (output the system VREF)
- Current sink capability for termination applications
- DDR and QDR compatible
- Pre-bias start-up capability
- Remote on/off
- Remote sense
- Undervoltage lockout
- POLA compatible
- True multi-sourcing flexibility (form, fit and function)
- Operating temperature range: -40 °C to 85 °C
- Protection: overcurrent/short-circuit
- Through-hole or surface-mount
- International safety standard approvals – UL, CSA, TÜV & CB Report

POLA Non-Isolated DDR/QDR Memory Bus Termination Modules

Output Current	Input Voltage	Output Voltage	Efficiency	Package L x W x H (mm)	Model Number *
6 A	2.95-3.65 Vdc	0.55-1.8 V	88%	0.87" x 0.495" x 0.335" (22.01 x 12.57 x 8.51)	PTH03050YAD
6 A	4.5-5.5 Vdc	0.55-1.8 V	87%	0.87" x 0.495" x 0.335" (22.01 x 12.57 x 8.51)	PTH05050YAD
6 A	10.8-13.2 Vdc	0.55-1.8 V	84%	0.87" x 0.495" x 0.335" (22.01 x 12.57 x 8.51)	PTH12050YAD
10 A	2.95-3.65 Vdc	0.55-1.8 V	86%	0.995" x 0.620" x 0.354" (25.27 x 15.75 x 8.99)	PTH03060YAD
10 A	4.5-5.5 Vdc	0.55-1.8 V	86%	0.995" x 0.620" x 0.354" (25.27 x 15.75 x 8.99)	PTH05060YAD
10 A	10.8-13.2 Vdc	0.55-1.8 V	83%	0.995" x 0.620" x 0.354" (25.27 x 15.75 x 8.99)	PTH12060YAD
15 A	10.8-13.2 Vdc	0.55-1.8 V	85%	1.37" x 0.620" x 0.354" (34.80 x 15.75 x 8.99)	PTH12010YAD
15 A	2.95-3.65 Vdc	0.55-1.8 V	88%	1.37" x 0.620" x 0.354" (34.80 x 15.75 x 8.99)	PTH03010YAD
15 A	4.5-5.5 Vdc	0.55-1.8 V	88%	1.37" x 0.620" x 0.354" (34.80 x 15.75 x 8.99)	PTH05010YAD

*Mounting Option Suffix:

D Horizontal through-hole (RoHS 6/6)

H Horizontal through-hole (RoHS 5/6)

S Surface-mount solder ball (RoHS 5/6)

Z Surface-mount solder ball (RoHS 6/6)

POLA – General Purpose

Choose POLA modules for multi-sourced and interoperable parts.

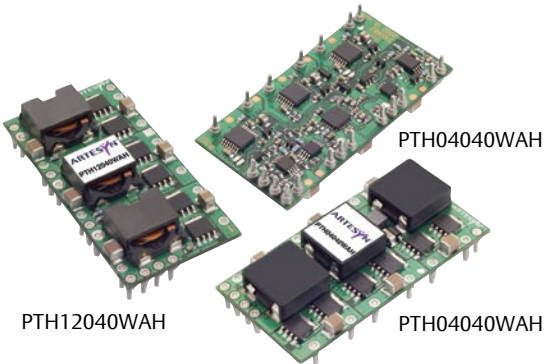

Special Features

- Input voltage ranges: 2.95-3.65 V, 4.5-5.5 V, 10.8-13.2 V
- Wide output voltage trim and adjustability: 0.8-5.5 V
- Output current: 6-60 A
- High efficiency up to 96%
- Auto-Track™ Sequencing
- Margin up/down controls
- Pre-bias start up capability
- Remote on/off
- Remote sense
- POLA compatible
- True multi-sourcing flexibility (form, fit and function)
- Operating temperature range: -40 °C to 85 °C
- Protection: overcurrent/short-circuit
- Through-hole or surface-mount
- International safety standard approvals – UL, CSA, TÜV & CB Report

General Purpose POLA Non-Isolated DC-DC Converters

Output Current	Input Voltage	Output Voltage	Efficiency	Package L x W x H (mm)	Model Number*
6 A	2.95-3.65 Vdc	0.8-2.5 V	94%	0.87" x 0.495" x 0.335" (22.01 x 12.57 x 8.51)	PTH03050WAD
6 A	4.5-5.5 Vdc	0.8-3.6 V	95%	0.87" x 0.495" x 0.335" (22.01 x 12.57 x 8.51)	PTH05050WAD
6 A	10.8-13.2 Vdc	0.8-1.8 V	88%	0.87" x 0.495" x 0.335" (22.01 x 12.57 x 8.51)	PTH12050LAD
6 A	10.8-13.2 Vdc	1.2-5.5 V	93%	0.87" x 0.495" x 0.335" (22.01 x 12.57 x 8.51)	PTH12050WAD
8 A	2.95-3.65 Vdc	0.8-2.5 V	93%	0.9" x 0.33" x 0.4" (22.86 x 8.38 x 10.16)	PTV03010WAD
8 A	4.5-5.5 Vdc	0.8-3.6 V	95%	0.9" x 0.33" x 0.4" (22.86 x 8.38 x 10.16)	PTV05010WAD
8 A	10.8-13.2 Vdc	0.8-1.8 V	87%	0.9" x 0.33" x 0.4" (22.86 x 8.38 x 10.16)	PTV12010LAD
8 A	10.8-3.2 Vdc	1.2-5.5 V	92%	0.9" x 0.33" x 0.4" (22.86 x 8.38 x 10.16)	PTV12010WAD
10 A	2.95-3.65 Vdc	0.8-2.5 V	93%	0.995" x 0.62" x 0.354" (25.27 x 15.75 x 8.99)	PTH03060WAD
10 A	4.5-5.5 Vdc	0.8-3.6 V	94%	0.995" x 0.62" x 0.354" (25.27 x 15.75 x 8.99)	PTH05060WAD
10 A	10.8-13.2 Vdc	0.8-1.8 V	88%	0.995" x 0.62" x 0.354" (25.27 x 15.75 x 8.99)	PTH12060LAD
10 A	10.8-3.2 Vdc	1.2-5.5 V	94%	0.995" x 0.62" x 0.354" (25.27 x 15.75 x 8.99)	PTH12060WAD
12 A	10.8-13.2 Vdc	0.8-1.8 V	89%	1.370" x 0.62" x 0.354" (34.80 x 15.75 x 8.99)	PTH12010LAD
12 A	10.8-13.2 Vdc	1.2-5.5 V	94%	1.370" x 0.62" x 0.354" (34.80 x 15.75 x 8.99)	PTH12010WAD
15 A	2.95-3.65 Vdc	0.8-2.5 V	93%	1.370" x 0.62" x 0.354" (34.80 x 15.75 x 8.99)	PTH03010WAD
15 A	4.5-5.5 Vdc	0.8-3.6 V	95%	1.370" x 0.62" x 0.354" (34.80 x 15.75 x 8.99)	PTH05010WAD
16 A	10.8-13.2 Vdc	0.8-1.8 V	87%	1.750" x 0.37" x 0.500" (44.45 x 9.4 x 12.7)	PTV12020LAD
16 A	10.8-13.2 Vdc	1.2-5.5 V	93%	1.750" x 0.37" x 0.500" (44.45 x 9.4 x 12.7)	PTV12020WAD
18 A	2.95-3.6 Vdc	0.8-2.5 V	95%	1.750" x 0.37" x 0.500" (44.45 x 9.4 x 12.7)	PTV03020WAD
18 A	4.5-5.5 Vdc	0.8-3.6 V	94%	1.750" x 0.37" x 0.500" (44.45 x 9.4 x 12.7)	PTV05020WAD
18 A	10.8-13.2 Vdc	0.8-1.8 V	89%	1.495" x 0.87" x 0.354" (37.97 x 22.01 x 8.99)	PTH12020LAD
18 A	10.8-13.2 Vdc	1.2-5.5 V	95%	1.495" x 0.87" x 0.354" (37.97 x 22.01 x 8.99)	PTH12020WAD
22 A	2.95-3.65 Vdc	0.8-2.5 V	95%	1.495" x 0.87" x 0.354" (37.97 x 22.01 x 8.99)	PTH03020WAD
22 A	4.5-5.5 Vdc	0.8-3.6 V	96%	1.495" x 0.87" x 0.354" (37.97 x 22.01 x 8.99)	PTH05020WAD
26 A	10.2-13.8 Vdc	0.8-1.8 V	89%	1.37" x 1.12" x 0.354" (34.80 x 28.45 x 8.99)	PTH12030LAD
26 A	10.2-13.8 Vdc	1.2-5.5 V	95%	1.37" x 1.12" x 0.354" (34.80 x 28.45 x 8.99)	PTH12030WAD
30 A	2.95-3.65 Vdc	0.8-2.5 V	93%	1.37" x 1.12" x 0.354" (34.80 x 28.45 x 8.99)	PTH03030WAD
30 A	4.5-5.5 Vdc	0.8-3.6 V	94%	1.37" x 1.12" x 0.354" (34.80 x 28.45 x 8.99)	PTH05030WAD
50 A	8.0-14 Vdc	0.8-5.5 V	96%	2.045" x 1.045" x 0.357" (51.94 x 26.54 x 9.07)	PTH12040WAD
60 A	2.95-2.5 Vdc	0.8-2.5 V	96%	2.045" x 1.045" x 0.357" (51.94 x 26.54 x 9.07)	PTH04040WAD

*Mounting Option Suffix:

D Horizontal through-hole (RoHS 6/6)
H Horizontal through-hole (RoHS 5/6)

S Surface-mount solder ball (RoHS 5/6)
Z Surface-mount solder ball (RoHS 6/6)

DDR Memory Power Module

Designers' tip: Check out the POLA memory bus termination models on page 57.

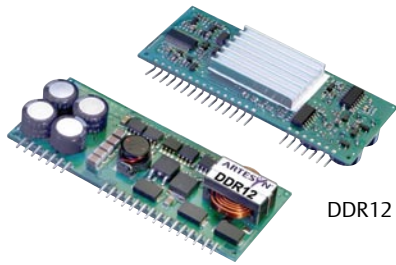

DDR12

Special Features

- High current dual-output power module for DDR memory
- Input voltage range: 10.8-13.2 V
- Output voltage adjustability: 2.32-2.75 V_{ddq}
- Single compact module provides 25 A @ 2.5 V for V_{ddq} supply and 8 A @ 1.25 V for V_{tt} termination
- V_{tt} output has sink capability for logic terminations
- Remote sense (V_{ddq} output only)
- Tracking dual output voltages
- Remote on/off
- Power good (open collector)
- Under voltage lockout
- Protection: overcurrent/short-circuit/overvoltage
- Operating temperature range: 0° C to 80° C
- International safety standard approvals – UL, CSA, TÜV and CB Report

Memory Power Non-Isolated DC–DC Converters

Output Current	Input Voltage	Output Voltage	Efficiency	Package L x W x H (mm)	Model Number
25 A & 8 A	10.8-13.2 Vdc	2.5 V & 1.25 V	84%	3.0" x 0.5" x 1.2" (76.20 x 12.7 x 30.48)	DDR12-25D08-AJ

Voltage Regulator Modules (VRM)

Emerson Network Power closely tracks leading semiconductor manufacturers' (Intel® and AMD) roadmaps and offer processor power converters designed specifically to match demands.

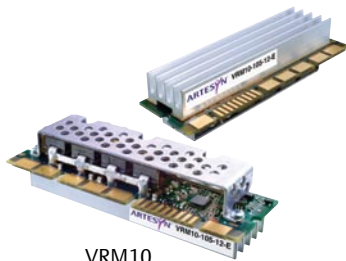

VRM10

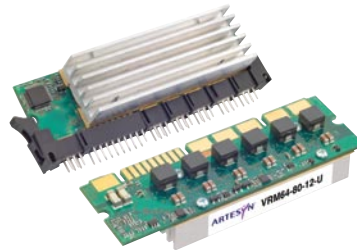

VRM64

Special Features

- Voltage regulator modules (VRMs) for both Intel and AMD64 microprocessors
- Input voltage ranges: 10.8-13.2 V , 11-12.6 V and 11-13.2 V
- Output currents up to 105 A
- Output voltage adjustability
- 5-bit and 6-bit VID inputs
- Allows dynamic VID code changes
- High efficiency up to 87%
- Exceptionally fast transient response in excess of 900 A/μs
- Remote on/off
- Differential remote sense
- Low profile to meet 1U applications
- Current sharing – no need for master/slave configurations
- Protection: overcurrent/short-circuit/overvoltage (with on-board fuse)
- International safety standard approvals – VDE

VRM Processor Non-Isolated DC–DC Converters

VRM Specifications	Output Current	Input Voltage	Output Voltage	Efficiency	Package L x W x H (mm)	Model Number
AMD64	80 A	10.8-13.2 Vdc	0.8-1.55 V	84%	3.68" x 0.75" x 1.25" (93.47 x 19.05 x 31.75)	VRM64-80-12-UY
VRM10.0, VRM10.1	105 A	11-12.6 Vdc	0.8375-1.60 V	84%	3.68" x 1.00" x 1.25" (93.35 x 25.4 x 31.75)	VRM10-105-12-EY
VRM10.0, VRM10.1	80 A	11-12.6 Vdc	0.8375-1.60 V	85%	3.19" x 0.77" x 1.24" (81.03 x 19.78 x 31.75)	VRM10-80-12-PY
VRM10.0, VRM10.1	85 A	11-12.6 Vdc	0.8375-1.60 V	85%	3.19" x 0.77" x 1.24" (81.03 x 19.78 x 31.75)	VRM10-85-12-UY

Power Factor Correction (PFC)



Special Features

- 1600 W/720 W
- Unity power factor
- Universal input and frequency range
- Positive and negative enable
- Paralleling with current share
- IEC 1000-3.2 compliance
- 100 °C baseplate
- Clock synch (in/out)
- Current monitoring
- Vout adjust
- On/off enable
- Remote sense
- 95% efficiency
- Fast transient response

Vout	Iout	Input Voltage	Package L x W x H (mm)	Efficiency	Model Number
PFC Module - Baseplate					
380 V	4.2 A	85-264 Vac	4.6" x 2.4" x 0.5" (116.84 x 60.96 x 12.7)	95%	AIF04ZPFC-01L
380 V	4.2 A	85-264 Vac	4.6" x 2.4" x 0.5" (116.84 x 60.96 x 12.7)	95%	AIF04ZPFC-02L
393 V	0.25 A	100-122 Vac	2.3" x 1.45" x 0.5" (57.91 x 36.83 x 12.7)	90%	AIQ00ZPFC-01NL
393 V	2.08 A	85-264 Vac	3.5" x 2.4" x 0.5" (88.9 x 60.96 x 12.7)	93%	AIT02ZPFC-01NL

High Power 300 Vin

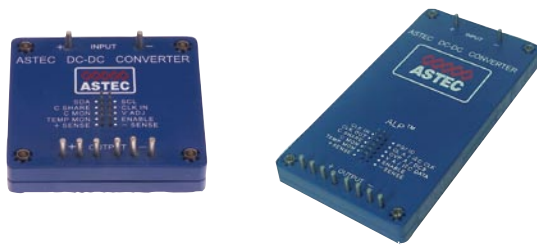

300 V input 65-600 W output

Special Features

- 300 V input (250-420 V PFC-ready)
- 2nd generation product
- Standard through-hole termination
- Power density >100 W/in³
- 100 °C max baseplate operating temperature
- Embedded controls on secondary side (Full- and Half-brick):
 - Temp monitor
 - Current sharing
 - Power good signal
 - Current limit & OVP adjust

	Vout	Iout	Input Voltage	Package L x W x H (mm)	Efficiency	Model Number
AIF 300 Vin	Full-Brick – Baseplate					
	1.8 V	120 A	300 V (250-420 V)	4.6" x 2.4" x 0.5" (116.84 x 60.96 x 12.7)	80%	AIF120Y300-L
	3.3 V	120 A	300 V (250-420 V)	4.6" x 2.4" x 0.5" (116.84 x 60.96 x 12.7)	87%	AIF120F300-L
	5 V	80 A	300 V (250-420 V)	4.6" x 2.4" x 0.5" (116.84 x 60.96 x 12.7)	90%	AIF80 A300-L
	12 V	50 A	300 V (250-420 V)	4.6" x 2.4" x 0.5" (116.84 x 60.96 x 12.7)	90%	AIF50B300-L
	15 V	40 A	300 V (250-420 V)	4.6" x 2.4" x 0.5" (116.84 x 60.96 x 12.7)	90%	AIF40C300-L
	24 V	25 A	300 V (250-420 V)	4.6" x 2.4" x 0.5" (116.84 x 60.96 x 12.7)	90%	AIF25H300-L
	48 V	12 A	300 V (250-420 V)	4.6" x 2.4" x 0.5" (116.84 x 60.96 x 12.7)	91%	AIF12W300-L
AIH 300 Vin	Half-Brick – Baseplate					
	1.8 V	50 A	300 V (250-420 V)	2.3" x 2.4" x 0.5" (58.42 x 60.96 x 12.7)	80%	AIH50Y300-L
	3.3 V	50 A	300 V (250-420 V)	2.3" x 2.4" x 0.5" (58.42 x 60.96 x 12.7)	85%	AIH50F300-L
	5 V	40 A	300 V (250-420 V)	2.3" x 2.4" x 0.5" (58.42 x 60.96 x 12.7)	88%	AIH40 A300-L
	12 V	20 A	300 V (250-420 V)	2.3" x 2.4" x 0.5" (58.42 x 60.96 x 12.7)	90%	AIH20B300-L
	15 V	16 A	300 V (250-420 V)	2.3" x 2.4" x 0.5" (58.42 x 60.96 x 12.7)	90%	AIH16C300-L
	24 V	10 A	300 V (250-420 V)	2.3" x 2.4" x 0.5" (58.42 x 60.96 x 12.7)	90%	AIH10H300-L
AIQ 300 Vin	Quarter-Brick – Baseplate					
	28 V	2.32 A	300 V (250-420 V)	2.3" x 1.45" x 0.5" (57.91 x 36.83 x 12.7)	89%	AIQ02R300L

On-board AC–DC Distributed Architecture

- High power and high density AC–DC building blocks for quick-turn and modular power solutions
- Alternative power solutions vs. custom development approach
- No fans and high reliability (1M hours MTBF)
- Suitable for harsh temperature conditions (-40 °C startup/-20 °C to 100 °C operating temperature)

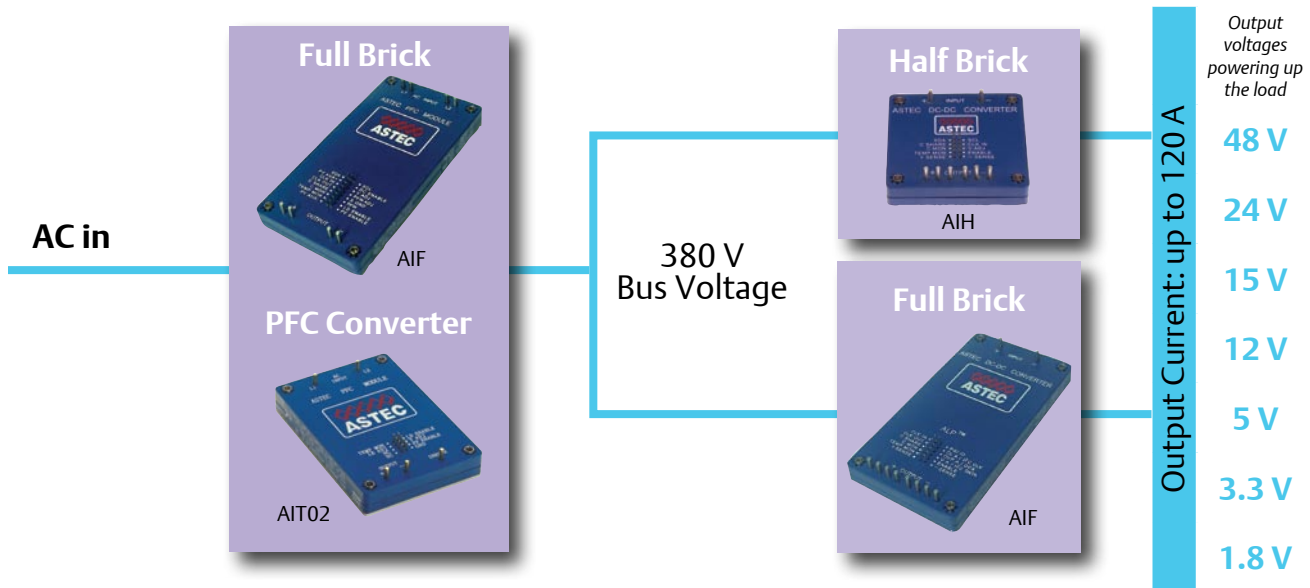

BXA Low Power



BXA30

Special Features

- Input voltages, 18-36 V, 36-75 V
- Single and dual outputs
- Power 3-40 W
- Regulated outputs
- Operating temperature -40 °C to 105 °C (ambient with derating)
- Protection: overcurrent/short-circuit
- 500-1500 Vdc isolation
- Enclosed and baseplate models
- UL, CSA and VDE safety approvals

	Input Voltage	Output Voltage	Package L x W x H (mm)	I/O Isolation	Efficiency	Model Number
3 W	Enclosed					
	18-36 V	5 V @ 0.5 A	1.25" x 0.8" x 0.5" (31.75 x 20.32 x 12.70)	500 V	76%	BXA3-24S05J
	36-75 V	5 V @ 0.5 A	1.25" x 0.8" x 0.5" (31.75 x 20.32 x 12.70)	500 V	76%	BXA3-48S05J
	36-75 V	15 V @ 0.2 A	1.25" x 0.8" x 0.5" (31.75 x 20.32 x 12.70)	500 V	76%	BXA3-48S15J
25 W	Baseplate					
36-75 V	5 V @ 5 A	3.02" x 2.41" x 0.52" (76.71 x 61.21 x 13.21)	1500 V	80%	BXA30-48S05J	
30 W	Baseplate					
	36-75 V	15 V @ 2 A	3.02" x 2.41" x 0.52" (76.71 x 61.21 x 13.21)	1500 V	87%	BXA30-48S15J
	36-75 V	5 V @ ±2.5 A	3.02" x 2.41" x 0.52" (76.71 x 61.21 x 13.21)	1500 V	80%	BXA30-48D05-FJ
	36-75 V	12 V @ ±1.25 A	3.02" x 2.41" x 0.52" (76.71 x 61.21 x 13.21)	1500 V	84%	BXA30-48D12J
	36-75 V	15 V @ ±1.0 A	3.02" x 2.41" x 0.52" (76.71 x 61.21 x 13.21)	1500 V	86%	BXA30-48D15J
40 W	Baseplate					
	18-36 V	3.3 V @ 7 A	2.20" x 2.2" x 0.5" (55.88 x 55.88 x 12.70)	1500 V	75%	BXA40-2453 V3-MJ
	36-75 V	12 V @ 3.3 A	2.20" x 2.2" x 0.5" (55.88 x 55.88 x 12.70)	1500 V	87%	BXA40-48S12-MJ

SXE & SXN Low Power

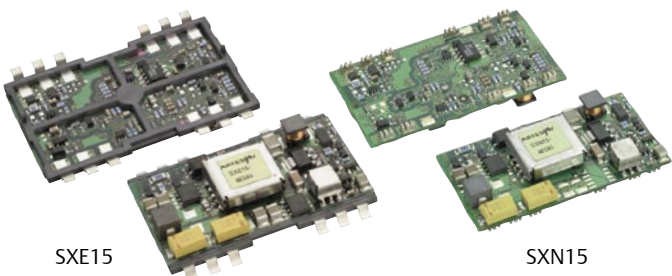

SXE15

SXN15

Special Features

- Input voltages 33-75 Vdc
- Single and dual outputs
- Power 10.8-15 W
- Regulated outputs
- High efficiency topology – 87% @ 5 Vdc
- Remote on/off
- ±10% output voltage trim
- Operating temperature -40 °C to 70 °C (ambient)
- Protection: overcurrent/short-circuit/overvoltage
- 1500 Vdc isolation
- UL, CSA & VDE safety approvals
- Surface-mount

	Input Voltage	Output Voltage	Package L x W x H (mm)	I/O Isolation	Efficiency	Model Number
15 W	Open-frame Surface-mounting					
	33-75 V	5 V @ 3 A	1.9" x 1.39" x 0.34" (48.26 x 35.31 x 8.64)	1500 V	87%	SXE15-48S05-RJ
	33-75 V	12 V @ 1.25 A	1.9" x 1.39" x 0.34" (48.26 x 35.31 x 8.64)	1500 V	85%	SXE15-48S12-RJ
	33-75 V	1.8 V @ 6 A	1.9" x 1.39" x 0.34" (48.26 x 35.31 x 8.64)	1500 V	83%	SXE15-48S1 V8-RJ
	33-75 V	2.5 V @ 6 A	1.9" x 1.39" x 0.34" (48.26 x 35.31 x 8.64)	1500 V	85%	SXE15-48S2 V5-RJ
	33-75 V	3.3 V @ 4.5 A	1.9" x 1.01" x 0.34" (48.26 x 25.65 x 8.64)	1500 V	86%	SXE15-48S3 V3-RJ
	33-75 V	5 V @ 3 A	1.9" x 1.01" x 0.34" (48.26 x 25.65 x 8.64)	1500 V	87%	SXN15-48S05-RJ
	33-75 V	1.8 V @ 6 A	1.9" x 1.01" x 0.34" (48.26 x 25.65 x 8.64)	1500 V	85%	SXN15-48S1 V8-RJ
	33-75 V	2.5 V @ 6 A	1.9" x 1.01" x 0.34" (48.26 x 25.65 x 8.64)	1500 V	85%	SXN15-48S2 V5-RJ
	33-75 V	3.3 V @ 4.5 A	1.9" x 1.01" x 0.34" (48.26 x 25.65 x 8.64)	1500 V	86%	SXN15-48S3 V3-RJ
	33-75 V	5 V @ 3 A & 3.3 V @ 4.5 A	1.9" x 1.39" x 0.34" (48.26 x 35.31 x 8.64)	1500 V	86%	SXE15-48D05-3 V3-RJ
	33-75 V	3.3 V @ 3.5 A & 2.5 V @ 4.5 A	1.9" x 1.01" x 0.34" (48.26 x 25.65 x 8.64)	1500 V	85%	SXN15-48D3 V3-2 V5RJ
	33-75 V	5 V @ 3 A & 3.3 V @ 4.5 A	1.9" x 1.01" x 0.34" (48.26 x 25.65 x 8.64)	1500 V	86%	SXN15-48D05-3 V3-RJ
	33-75 V	3.3 V @ 3.5 A & 2.5 V @ 4.5 A	1.9" x 1.01" x 0.34" (48.26 x 25.65 x 8.64)	1500 V	85%	SXN15-48D3 V3-2 V5RJ

CXA Low Power

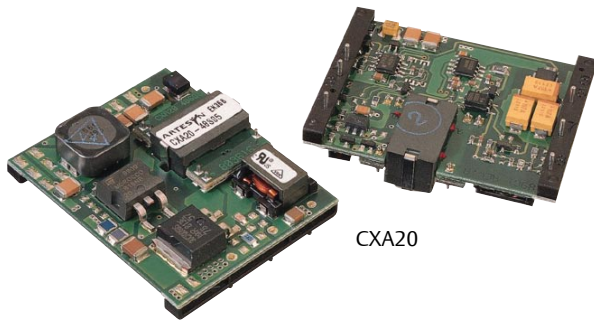

CXA20

Special Features

- 4:1 input voltage range, 18-75 V
- Single and dual outputs
- Power 20 W
- Regulated outputs
- Remote on/off
- ± 10% output voltage trim
- Operating temperature -40 °C to 70 °C (ambient)
- Protection: overcurrent/short-circuit/overvoltage
- Basic insulation, 1500 Vdc
- UL, CSA & VDE safety approvals

	Input Voltage	Output Voltage	Package L x W x H (mm)	I/O Isolation	Efficiency	Model Number
10 W	Open-frame					
	18-75 V	5 V @ 2 A	2" x 1" x 0.39" (50.80 x 25.40 x 10.00)	1500 V	81%	CXA10-48S05J
	18-75 V	12 V @ 0.83 A	2" x 1" x 0.39" (50.80 x 25.40 x 10.00)	1500 V	83%	CXA10-48S12J
	18-75 V	3.3 V @ 2.4 A	2" x 1" x 0.39" (50.80 x 25.40 x 10.00)	1500 V	78%	CXA10-48S3V3J
	18-75 V	5 V @ ±1.0 A	2" x 1" x 0.39" (50.80 x 25.40 x 10.00)	1500 V	81%	CXA10-48D05J
	18-75 V	12 V @ ±0.41 A	2" x 1" x 0.39" (50.80 x 25.40 x 10.00)	1500 V	83%	CXA10-48D12J
20 W	Open-frame					
	18-75 V	5 V @ 4 A	2" x 1.6" x 0.41" (50.80 x 40.64 x 10.41)	1500 V	83%	CXA20-48S05J
	18-75 V	12 V @ 1.66 A	2" x 1.6" x 0.41" (50.80 x 40.64 x 10.41)	1500 V	83%	CXA20-48S12J
	18-75 V	3.3 V @ 6 A	2" x 1.6" x 0.41" (50.80 x 40.64 x 10.41)	1500 V	80%	CXA20-48S3V3J
	18-75 V	5 V @ ±2.0 A	2" x 1.6" x 0.41" (50.80 x 40.64 x 10.41)	1500 V	84%	CXA20-48D05J
	18-75 V	12 V @ ±0.83 A	2" x 1.6" x 0.41" (50.80 x 40.64 x 10.41)	1500 V	84%	CXA20-48D12J



Terms and Conditions

Terms and Conditions of Sale

The Emerson Network Power company that accepts Buyer's order for Goods is herein referred to as the "Seller" and the person or entity purchasing goods or services ("Goods") and/or licensing software and/or firmware which are preloaded, or to be loaded into Goods ("Software") from Seller is referred to as the "Buyer." These Terms and Conditions, any price list or schedule, quotation, acknowledgment or invoice from Seller relevant to the sale of the Goods and licensing of Software and all documents incorporated by specific reference herein or therein constitute the complete and exclusive statement of the terms of the agreement governing the sale of Goods and license of Software by Seller to Buyer. Seller's acceptance of Buyer's purchase order is expressly conditional on Buyer's assent to all of Seller's terms and conditions of sale, including terms and conditions that are different from or additional to the terms and conditions of Buyer's purchase order. Buyer's acceptance of the Goods and/or Software will manifest Buyer's assent to these Terms and Conditions. Seller reserves the right in its sole discretion to refuse orders. Notwithstanding anything to the contrary, in the event that the provisions of these Terms and Conditions conflict with the provisions of an effective agreement signed by a duly authorized representative of both parties ("Effective Agreement") that applies to the transaction(s) contemplated herein, the Effective Agreement shall control.

1. PRICES: Unless otherwise specified in writing by Seller, the price quoted or specified by Seller for the Goods and/or Software shall remain in effect for thirty (30) days after the date of Seller's quotation or acknowledgment of Buyer's order for the Goods and/or Software, whichever occurs first, provided an unconditional authorization from Buyer for the shipment of the Goods and/or Software is received and accepted by Seller within such time period. If such authorization is not received by Seller within such thirty (30) day period, Seller shall have the right to change the price for the Goods and/or Software to Seller's price for the Goods and/or Software at the time of shipment. All prices and licensee fees are exclusive of taxes, transportation and insurance, which are to be borne by Buyer.

2. TAXES: Any current or future tax or governmental charge (or increase in same) affecting Seller's costs of production, sale, or shipment, or which Seller is otherwise required to pay or collect in connection with the sale, purchase, delivery, storage, processing, use or consumption of Goods, shall be for Buyer's account and shall be added to the price or billed to Buyer separately, at Seller's election.

3. TERMS OF PAYMENT: Unless otherwise specified by Seller, terms are net thirty (30) days from date of Seller's invoice in U.S. currency. Seller shall have the right, among other remedies, either to terminate this agreement or to suspend further performance under this and/or other agreements with Buyer in the event Buyer fails to make any payment when due, which other agreements Buyer and Seller hereby amend accordingly. Buyer shall be liable for all expenses, including attorneys' fees, relating to the collection of past due amounts. If any payment owed to Seller is not paid when due, it shall bear interest, at a rate to be determined by Seller, which shall not exceed the maximum rate permitted by law, from the date on which it is due until it is paid. Any payment due to either party under this agreement shall be made in full without any set-off, restriction, condition deduction or withholding for or on account of any counterclaim. Should Buyer's financial responsibility become unsatisfactory to Seller, cash payments or security satisfactory to Seller may be required by Seller for future deliveries of the Goods and/or Software. If such cash payment or security is not provided, in addition to Seller's other rights and remedies, Seller may discontinue deliveries.

4. SHIPMENT AND DELIVERY: While Seller will use all reasonable commercial efforts to maintain the delivery date(s) acknowledged or quoted by Seller, all shipping dates are approximate and not guaranteed. Seller reserves the right to make partial shipments. Seller, at its option, shall not be bound to tender delivery of any Goods and/or Software for which Buyer has not provided shipping instructions and other required information. If the shipment of the Goods and/or Software is postponed or delayed by Buyer for any reason, Buyer agrees to reimburse Seller for any and all storage costs and other additional expenses resulting therefrom. Risk of loss and legal title to the Goods shall transfer from Seller to Buyer upon delivery to and receipt by carrier at Seller's shipping point. Unless otherwise specified by Seller, all shipments are F.C.A. Seller's shipping point (Incoterms 2000). Any claims for shortages or damages suffered in transit are the responsibility of Buyer and shall be submitted by Buyer directly to the carrier. Shortages or damages must be identified and signed for at the time of delivery.

Buyer shall inspect Goods delivered to it by Seller immediately upon receipt, and, any course of dealing to the contrary notwithstanding, failure of Buyer to give Seller notice of any claim within 10 days after receipt of such Goods shall be an unqualified acceptance of such Goods.

5. LIMITED WARRANTY: Subject to the limitations of Section 6 and unless otherwise specified by Seller in writing, Seller warrants that the Goods manufactured by Seller will be free from defects in material and workmanship and substantially meet Seller's published specifications at the time of shipment under normal use and regular service and maintenance for (a) the period specified in Seller's then current product datasheets from the date of manufacture by Seller for standard Embedded Power Goods, (b) two (2) years from initial shipment for standard Embedded Computing Goods, and (c) the period specified by Seller in writing for custom Embedded Power Goods and custom Embedded Computing Goods. Unless otherwise stated in a separate Software license agreement, Seller makes no warranty as to any Software. **THE WARRANTIES SET**

FORTH IN SECTIONS 5 AND 7 ARE THE SOLE AND EXCLUSIVE WARRANTIES GIVEN BY SELLER WITH RESPECT TO THE GOODS AND SOFTWARE AND ARE IN LIEU OF AND EXCLUDE ALL OTHER WARRANTIES, EXPRESS OR IMPLIED, ARISING BY OPERATION OF LAW OR OTHERWISE, INCLUDING WITHOUT LIMITATION, MERCHANTABILITY AND FITNESS FOR A PARTICULAR PURPOSE WHETHER OR NOT THE PURPOSE OR USE HAS BEEN DISCLOSED TO SELLER IN SPECIFICATIONS, DRAWINGS OR OTHERWISE, AND WHETHER OR NOT SELLER'S PRODUCTS ARE SPECIFICALLY DESIGNED AND/OR MANUFACTURED BY SELLER FOR BUYER'S USE OR PURPOSE.

These warranties do not extend to any losses or damages due to misuse, accident, abuse, neglect, negligence (other than Seller's), unauthorized modification or alteration, use beyond rated capacity, unsuitable power sources or environmental conditions, improper installation, repair, handling, maintenance or application or any other cause not the fault of Seller. To the extent that Buyer or its agents have supplied specifications, information, representation of operating conditions or other data to Seller in the selection or design of the Goods and the preparation of Seller's quotation, and in the event that actual operating conditions or other conditions differ from those represented by Buyer, any warranties or other provisions contained herein that are affected by such conditions shall be null and void.

If within thirty (30) days after Buyer's discovery of any warranty defects within the warranty period, Buyer notifies Seller thereof in writing, Seller shall, at its option and as Buyer's exclusive remedy, repair, correct or replace per its return policy, or refund the purchase price for, that portion of the Goods found by Seller to be defective. Failure by Buyer to give such written notice within the applicable time period shall be deemed an absolute and unconditional waiver of Buyer's claim for such defects. Advance written permission to return Goods must be obtained from Seller. Such Goods must be shipped transportation prepaid to Seller. Returns made without proper written permission will not be accepted by Seller. Seller reserves the right to inspect Goods prior to authorizing return. Goods repaired or replaced during the warranty period shall be covered by the foregoing warranties for the remainder of the original warranty period or ninety (90) days from the date of shipment, whichever is longer.

Buyer assumes all other responsibility for any loss, damage, or injury to persons or property arising out of, connected with, or resulting from the use of Goods and/or Software, either alone or in combination with other products/components.

PRE-PRODUCTION (Prototype, Engineering Verification Test, or Design Verification Test) UNITS ARE SOLD "WHERE IS, AS IS, WITH ALL FAULTS" WITHOUT WARRANTY OF ANY KIND, EXPRESS OR IMPLIED, INCLUDING, WITHOUT LIMITATION, IMPLIED WARRANTIES OF MERCHANTABILITY OR FITNESS FOR INTENDED PURPOSE.

6. LIMITATION OF REMEDY AND LIABILITY: THE SOLE AND EXCLUSIVE REMEDY FOR BREACH OF ANY WARRANTY HEREUNDER (OTHER THAN THE WARRANTY PROVIDED UNDER SECTION 7) SHALL BE LIMITED TO REPAIR, CORRECTION OR REPLACEMENT, OR REFUND OF THE PURCHASE PRICE UNDER SECTION 5.

SELLER SHALL NOT BE LIABLE FOR DAMAGES CAUSED BY DELAY IN PERFORMANCE AND THE REMEDIES OF BUYER SET FORTH IN THIS AGREEMENT ARE EXCLUSIVE. IN NO EVENT, REGARDLESS OF THE FORM OF THE CLAIM OR CAUSE OF ACTION (WHETHER BASED IN CONTRACT, INFRINGEMENT, NEGLIGENCE, STRICT LIABILITY, OTHER TORT OR OTHERWISE), SHALL SELLER'S LIABILITY TO BUYER AND/OR ITS CUSTOMERS EXCEED THE PRICE PAID BY BUYER FOR THE SPECIFIC GOODS OR SOFTWARE PROVIDED BY SELLER GIVING RISE TO THE CLAIM OR CAUSE OF ACTION. BUYER AGREES THAT IN NO EVENT SHALL SELLER'S LIABILITY TO BUYER AND/OR ITS CUSTOMERS EXTEND TO INCLUDE INCIDENTAL, CONSEQUENTIAL OR PUNITIVE DAMAGES. The term "consequential damages" shall include, but not be limited to, loss of anticipated profits, business interruption, loss of use, revenue, reputation and data, costs incurred, including without limitation, for capital, fuel, power and loss or damage to property or equipment. It is expressly understood that any technical advice furnished by Seller with respect to the use of the Goods and/or Software is given without charge, and Seller assumes no obligation or liability for the advice given, or results obtained, all such advice being given and accepted at Buyer's risk.

7. PATENTS AND COPYRIGHTS: Subject to the limitations of the second paragraph of Section 6, Seller warrants that the Goods sold, except as are made specifically for Buyer according to Buyer's specifications, do not infringe any valid U.S. patent or copyright in existence as of the date of shipment. This warranty is given upon the condition that Buyer promptly notify Seller of any claim or suit involving Buyer in which such infringement is alleged and cooperate fully with Seller and permit Seller to control completely the defense, settlement or compromise of any such allegation of infringement. Seller's warranty as to utility patents only applies to infringement arising solely out of the inherent operation according to Seller's specifications and instructions of such Goods. In the event such Goods are held to infringe such a U.S. patent or copyright in such suit, and the use of such Goods is enjoined, or in the case of a compromise or settlement by Seller, Seller shall have the right, at its option and expense, to procure for Buyer the right to continue using such Goods, or replace them with non-infringing Goods, or modify same to become non-infringing, or grant

Buyer a credit for the depreciated value of such Goods and accept return of them. In the event of the foregoing, Seller may also, at its option, cancel the agreement as to future deliveries of such Goods, without liability.

8. EXCUSE OF PERFORMANCE: Seller shall not be liable for delays in performance or for non-performance due to acts of God; acts of Buyer; war; fire; flood; weather; sabotage; epidemics; strikes or labor disputes; civil disturbances or riots; governmental requests, restrictions, allocations, laws, regulations, orders or actions; unavailability of or delays in transportation; default of suppliers; or unforeseen circumstances or any events or causes beyond Seller's reasonable control. Deliveries or other performance may be suspended for an appropriate period of time or canceled by Seller upon notice to Buyer in the event of any of the foregoing, but the balance of the agreement shall otherwise remain unaffected as a result of the foregoing.

If Seller determines that its ability to supply the total demand for the Goods, or to obtain material used directly or indirectly in the manufacture of the Goods, is hindered, limited or made impracticable due to causes set forth in the preceding paragraph, Seller may allocate its available supply of the Goods or such material (without obligation to acquire other supplies of any such Goods or material) among its purchasers on such basis as Seller determines to be equitable without liability for any failure of performance which may result therefrom.

9. RESCHEDULE/CANCELLATION: Unless otherwise agreed in writing by Seller, orders under this agreement may not be rescheduled or canceled by Buyer for any reason.

10. CHANGES: Buyer may request changes or additions to the Goods and/or Software consistent with Seller's specifications and criteria. In the event such changes or additions are accepted by Seller, Seller may revise the price, license fees and dates of delivery. Seller reserves the right to change designs and specifications for the Goods and/or Software without prior notice to Buyer, except with respect to Goods and/or Software being made-to-order for Buyer. Seller shall have no obligation to install or make such change in any Goods and/or Software manufactured prior to the date of such change.

11. NUCLEAR/MEDICAL: GOODS AND SOFTWARE SOLD HEREUNDER ARE NOT FOR USE IN CONNECTION WITH ANY NUCLEAR, MEDICAL, LIFESUPPORT AND OTHER HIGH RISK APPLICATIONS WHERE GOODS OR SOFTWARE FAILURE COULD LEAD TO LOSS OF LIFE OR CATASTROPHIC PROPERTY DAMAGE. Buyer accepts Goods and Software with the foregoing understanding, agrees to communicate the same in writing to any subsequent purchasers or users and to defend, indemnify and hold harmless Seller from any claims, losses, suits, judgments and damages, including incidental and consequential damages, arising from such use, whether the cause of action be based in tort, contract or otherwise, including allegations that the Seller's liability is based on negligence or strict liability.

12. ASSIGNMENT: Buyer shall not assign its rights or delegate its duties hereunder or any interest herein without the prior written consent of Seller, and any such assignment, without such consent, shall be void.

13. SOFTWARE: Notwithstanding any other provision herein to the contrary, Seller or applicable third party licensor to Seller shall retain all rights of ownership and title in its respective Software, including without limitation all rights of ownership and title in its respective copies of such Software. Except as otherwise provided herein, Buyer is hereby granted a nonexclusive, non-transferable royalty free license to use the Software incorporated into the Goods solely for purposes of Buyer properly utilizing such Goods purchased from Seller. All other Software shall be furnished to, and used by, Buyer only after execution of Seller's (or the licensor's) applicable standard license agreement, the terms of which are incorporated herein by reference. The Software is Seller's own or Seller's supplier's proprietary information, and Buyer and its employees and agents shall not disclose the Software to others without Seller's prior written consent.

14. TOOLING: Tool, die, and pattern charges, if any, are in addition to the price of the Goods and are due and payable upon completion of the tooling. All such tools, dies and patterns shall be and remain the property of Seller. Charges for tools, dies, and patterns do not convey to Buyer, title, ownership interest in, or rights to possession or removal, or prevent their use by Seller for other purchasers, except as otherwise expressly provided by Seller and Buyer in writing with reference to this provision.

15. DRAWINGS: Seller's prints and drawings (including without limitation, the underlying technology) furnished by Seller to Buyer in connection with this agreement are the property of Seller and Seller retains all rights, including without limitation, exclusive rights of use, licensing and sale. Possession of such prints or drawings does not convey to Buyer any rights or license, and Buyer shall return all copies (in whatever medium) of such prints or drawings to Seller immediately upon request therefor.

16. BUYER'S COMPLIANCE WITH LAWS: In connection with the transactions contemplated by this agreement, Buyer is familiar with and shall fully comply with all applicable laws, regulations, rules and other requirements of the United States and of any applicable state, foreign and local governmental body in connection with the purchase, license, receipt, use, transfer and disposal of the Goods and/or Software.

17. EXPORT/IMPORT: Buyer agrees that all applicable import and export control laws, regulations, orders and requirements, including without limitation those of the United States and the European Union, and the jurisdictions in which the Seller and Buyer are established or from which Goods and/or Software may be supplied, will apply to their receipt and use. In no event shall Buyer use, transfer, release, import, export, Goods and/or Software in violation of such applicable laws, regulations, orders or requirements.

18. GOVERNMENT CONTRACT CONDITIONS: In the event Buyer supplies Goods or Software to the U.S. Government or to a prime contractor selling to the U.S. Government, the following Federal Acquisition Regulation (FAR) clauses are accepted by Seller and are made part of this agreement applicable to such supply: 52.222-21 Prohibition of Segregated Facilities; 52.222-26 Equal Opportunity; 52.222-35 Equal Opportunity For Special Disabled Veterans, Veterans of Vietnam Era, and Other Eligible Veterans; 52.222-36 Affirmative Action For Workers with Disabilities; and 52.219-8 Utilization of Small Business Concerns. No additional FAR or FAR Supplement clauses are accepted by Seller. In the event Buyer elects to sell Goods or Software to the U.S. Government or any national, state, provincial or local non-U.S. governmental entity or to a prime contractor selling to such entities, Buyer does so solely at its own option and risk, and agrees not to obligate Seller as a sub-contractor or otherwise to the U.S. Government or other governmental entity except as described in this Section 18. Buyer remains solely and exclusively responsible for compliance with all statutes and regulations governing sales to the U.S. Government or any national, state, provincial or local non-U.S. governmental entity. Seller makes no representations, certifications or warranties whatsoever with respect to the ability of its Goods, Software, or prices to satisfy any such statutes and regulations.

19. GENERAL PROVISIONS: These terms and conditions supersede all other communications, negotiations and prior oral or written statements regarding the subject matter of these terms and conditions. No change, modification, rescission, discharge, abandonment, or waiver of these terms and conditions shall be binding upon the Seller unless made in writing and signed on its behalf by a duly authorized representative of Seller. No conditions, usage of trade, course of dealing or performance, understanding or agreement purporting to modify, vary, explain, or supplement these terms and conditions shall be binding unless hereafter made in writing and signed by the party to be bound, and no modification or additional terms shall be applicable to this agreement by Seller's receipt, acknowledgment, or acceptance of purchase orders, shipping instruction forms, or other documentation containing terms at variance with or in addition to those set forth herein. Any such modifications or additional terms are specifically rejected and deemed a material alteration hereof. If this document shall be deemed an acceptance of a prior offer by Buyer, such acceptance is expressly conditional upon Buyer's assent to any additional or different terms set forth herein. No waiver by either party with respect to any breach or default or of any right or remedy, and no course of dealing, shall be deemed to constitute a continuing waiver of any other breach or default or of any other right or remedy, unless such waiver be expressed in writing and signed by the party to be bound. All typographical or clerical errors made by Seller in any quotation, acknowledgment or publication are subject to correction. In the event that any provision or portion thereof contained in the Contract is held to be unenforceable, the Contract shall be construed without such provision or portion thereof.

(A) If Seller is a U.S. incorporated entity: This Agreement shall be governed by the laws of the State of Delaware, U.S.A., without reference to its choice or conflict of laws principles. The parties agree to submit to the exclusive jurisdiction of the courts of the State of Delaware for all actions arising in connection herewith.

(B) If Seller is a European incorporated entity: This Agreement shall be governed by the laws of England. Any dispute arising out of or in connection with this Agreement that cannot be resolved through friendly consultation shall be referred to and finally resolved by arbitration in London, England before the London Court of International Arbitration in accordance with its arbitration rules. The arbitral award shall be final and binding on the parties.

(C) If Seller is an entity incorporated in the Asia Pacific region: This Agreement shall be governed by the laws of the Hong Kong Special Administrative Region of the People's Republic of China. Any dispute arising out of or in connection with this Agreement that cannot be resolved through friendly consultation shall be referred to and finally resolved by arbitration in Hong Kong before the Hong Kong International Arbitration Centre in accordance with its arbitration rules. The arbitral award shall be final and binding on the parties.

(D) No action, regardless of form, arising out of transactions relating to this agreement, may be brought by either party more than two (2) years after the cause of action has accrued. The U.N. Convention on Contracts for the International Sales of Goods shall not apply to this agreement.

Revised February 6, 2009

Technology Index

Section	Page	Section	Page	Section	Page
Low Power		Intelligent High Power		Industry Standard Non-Isolated	
LCT	7	iVS	27, 28, 29, 30	APA	55
LPQ	9, 10, 11, 12	Bulk Power		APC	55
LPS	7, 8, 9, 10, 11, 12	HPS	31, 32, 33	DDR	59
LPT	7, 8, 9, 10	UFE	31, 32, 33	LDO	53
NFS	8, 10	Distributed Power		LGA	54
NLP	7, 9, 10, 12	DS	34, 35, 36, 37, 38	PTH	57, 58
NPS	8	Din Rail		PTV	58
NTQ	10, 11	ADN	39	SIL	52, 53, 55
NTS	12	MicroTCA		SMT	52, 53, 55, 56
TLP	11	MTC	40, 41	VRM	59
External Power		AdvancedTCA		High Power	
AD	14, 15	ATC	44	AIF	60
DA	13, 14	Industry Standard Isolated		AIH	60
DCH	13	AED	51	AIQ	60
DP	14	AEH	49	AIT	60
DPS	15	AEO	46	BXA	62
DPT	14	AEQ	47, 51	CXA	63
Medical Power		ALD	45, 51	SXE	62
AD	19	ALH	49	SXN	62
DA	19	ALO	46		
DP	19	ALQ	47, 51		
DPS	19	BXB	49		
DPT	19	EXB	49, 50		
iMP	18	EXQ	48		
iVS	18	IBC	51		
LPQ	18	LES	46		
LPS	16, 17, 18	LQD	48		
LPT	16, 17	LQS	47		
NFS	16, 17	RFB	50		
NLP	17, 18	RFF	50		
NPS	16				
NTS	18				
TLP	17				
Medium Power					
MP	20, 21, 22				
Intelligent Medium Power					
iMP	23, 24, 25, 26				

Ecosystem Leadership

Just as nature relies on communities of organisms functioning as an ecological unit, embedded power solutions depend on a broad and powerful ecosystem, including standards bodies, industry associations, technology alliances and engineering communities. Emerson Network Power brings a wealth of innovation and many years experience to accredited standards development organizations, specification consortia and industry associations through our executive memberships and key committee positions. We have long been committed to a strong ecosystem that works to further the development of the industries and technologies that are important to our customers' success.



Emerson, Emerson. Consider It Solved, Business-Critical Continuity and Emerson Network Power are trademarks of Emerson Electric Co. or one of its affiliated companies. PICMG, AdvancedTCA, ATCA, MicroTCA, and the AdvancedTCA and MicroTCA logos are trademarks of the PCI Industrial Computer Manufacturers Group. Intel is a trademark or registered trademark of Intel Corporation or its subsidiaries in the US and other countries. PMBus and the PMBus logo are trademarks of System Management Interface Forum, Inc. The word mark "The Green Grid" and The Green Grid design mark or logo are service marks of The Green Grid Association. All other trademarks are the property of their respective owners. ©2010 Emerson Electric Co.

Emerson Network Power.

The global leader in enabling *Business Critical Continuity*™.

- | | | | |
|--------------|--|----------------------------|-----------------------------|
| AC Power | Embedded Computing | Outside Plant | Racks & Integrated Cabinets |
| Connectivity | Embedded Power | Power Switching & Controls | Services |
| DC Power | Infrastructure Management & Monitoring | Precision Cooling | Surge Protection |

Americas

5810 Van Allen Way
Carlsbad, CA 92008
USA
Telephone: +1 760 930 4600
Facsimile: +1 760 930 0698

Europe (UK)

Waterfront Business Park
Merry Hill, Dudley
West Midlands, DY5 1LX
United Kingdom
Telephone: +44 (0) 1384 842 211
Facsimile: +44 (0) 1384 843 355

Asia (HK)

14/F, Lu Plaza
2 Wing Yip Street
Kwun Tong, Kowloon
Hong Kong
Telephone: +852 2176 3333
Facsimile: +852 2176 3888

For global contact, visit:

Emerson.com/EmbeddedPower

TechSupport.EmbeddedPower@Emerson.com

While every precaution has been taken to ensure accuracy and completeness in this literature, Emerson Network Power assumes no responsibility, and disclaims all liability for damages resulting from use of this information or for any errors or omissions.

Printed in USA
Issue SF5 2010

EmersonNetworkPower.com