

**Proven Capabilities in Converged
IP Voice, Video and Data**

Contents

Contents

	Allied Telesis	3
	Market Solutions	4
	PartnerPortal	6
	Global Service & Support Programs	7
	Unmanaged Switches	8
	WebSmart Switches	10
	Power over Ethernet Switches	12
	Fast Ethernet Switches	14
	Gigabit Edge / Aggregation Switches	16
	Gigabit Aggregation / Core Switches	18
	10 Gigabit Switches	20
	SwitchBlade	22
	Optical Network Components	24
	Optical Network Media Conversion	26
	Network Interface Cards	32
	Routers	38
	Wireless	40
	iMAP integrated Multiservice Access Platforms	46
	iMG intelligent Multiservice Gateways	50
	Network Management & Software	52
	Our Locations	54
	Product A-Z	55

Allied Telesis

Allied Telesis is a world class leader in delivering IP/Ethernet network solutions to the global marketplace. We create innovative, standards-based IP networks that seamlessly connect users with their voice, video and data services.

We are an international company headquartered in Japan with major divisions in Europe, Asia and North and South America. Our partners include the world's largest distributors, integrators, solution providers and resellers to assure you receive immediate local service and support.

Our worldwide research and development centers work to bring you innovative products that help your company succeed. We also operate state-of-the-art production facilities, compliant with the world's stringent environmental policies, manufacturing more than 600 different products every month, which are shipped globally.

As a major industry manufacturer and importer, Allied Telesis is committed to providing you with products designed and built to the highest possible quality. Our manufacturing conforms to appropriate ISO 9000 standards, and all of our facilities adhere to the strict ISO 14001 standard to ensure a healthy world environment.

Allied Telesis...

Known for reliability

Chosen for affordability

Awarded for innovation

Allied Telesis has been designing, manufacturing and selling networking products for over 20 years. Our philosophy of producing products of the highest quality, at affordable prices, has resulted in Allied Telesis products being deployed in networks of all types and sizes across the world. Our proven track record of providing solid technology, excellent support and full feature products has allowed Allied Telesis to become the worldwide de-facto standard in many areas of technology. With a portfolio of products that can provide end-to-end networking for both Service Provider, Enterprise and SMB customers, Allied Telesis is the natural choice for many world class organizations.

For more than 20 years, Allied Telesis has been a leading provider of networking infrastructure. Today the Company enables delivery of voice, video, and data services to a variety of clients globally. The Company is committed to innovating the way in which services and applications are delivered and managed, resulting in increased value and lower operating costs.

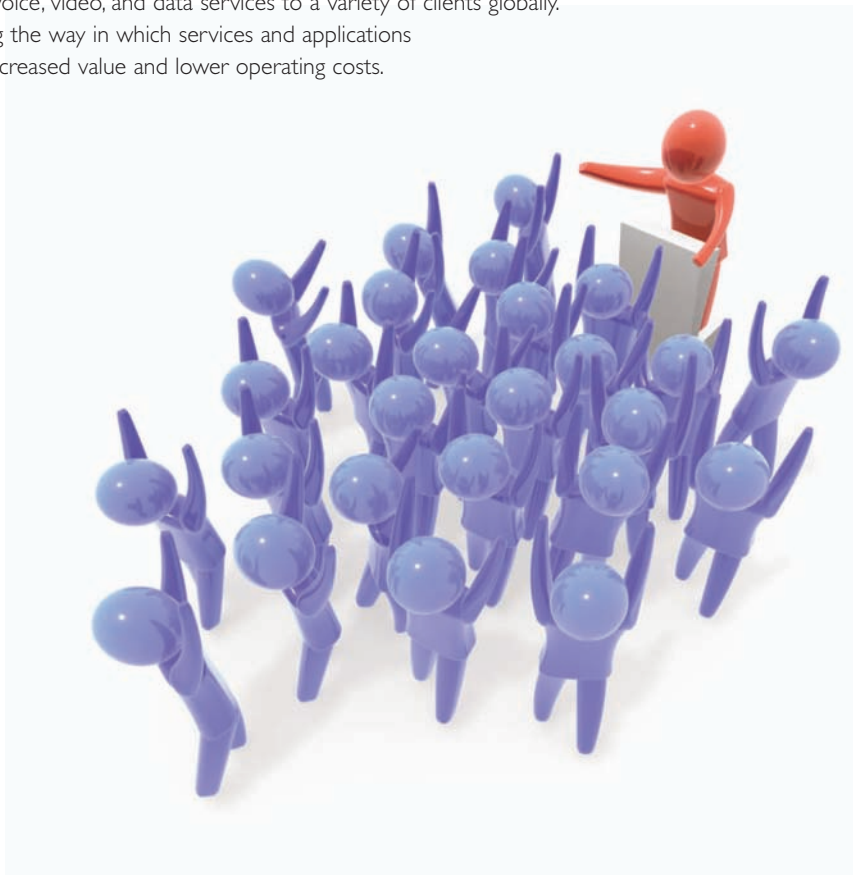



Market Solutions



Carriers and PTTs

Competitive carriers can differentiate themselves by deploying Triple Play services that provide voice, video and data via one access line, together with deployment of fiber optics for the infrastructure. Our residential service gateways provide true end-to-end differentiation for IOCs, versus legacy ATM/TDM solutions. Together, they make a compelling combination.



Public Utilities

Many utilities are investing in technology to deliver backbone services over their fiber plant to local communities and private businesses. Our IP/Ethernet solutions for FTTx include an end-to-end suite of products optimized to deliver wholesale access, retail services or a combination of both.



Education

High-bandwidth, secure networks help deliver advanced teaching and communications tools that benefit students, teachers and administrators through virtual online classrooms, remote access to teaching specialists and automated attendance programs. Our high performance, multi-layer switching solutions provide intelligent, scalable and reliable connectivity from 10Mbps to 10Gbps.



Multi-Tenant and Multi-Dwelling Units (MTU/MDU)

By meeting a growing demand from business and residential tenants for bundled voice, video and data services, you can profitably compete with incumbent telephone and cable operators to offer services in your Multi-Dwelling or Multi-Tenant Units. Our IP/Ethernet solutions help you efficiently consolidate access traffic and offer scalable high-speed services to the residents and companies who share your buildings.



Healthcare

Advances in voice, video and data networking can make medical professionals faster, more accurate and more patient friendly. Our solutions keep you compliant with privacy regulations and help open up new opportunities for both patient care and broadband 'to-the-pillow' services, including audio and Internet services, pay-per-use channels and Video-on-Demand (VoD).



Cities and Municipalities

Many municipalities and cities are building their own funded backbone and access networks to provide high-speed Internet, telephone and video to employees, residents and businesses. Our wired and wireless broadband IP/Ethernet solutions help municipalities and cities to build the most scalable, flexible, and cost-effective voice, video and data infrastructure available today.



Defence

The defence industry requires high reliability and high availability, coupled with a wide range of applications from voice, video and data. Our networking solutions provide much of the networking need, from client connectivity through to infrastructure, especially using fiber optic cabling.



Finance

Finance covers an extremely wide range of possible requirements, from simple credit card authorization in a small retail outlet, to powering the world's stock markets. Allied Telesis solutions easily scale, providing an ideal network infrastructure in this fast moving industry. With heavy emphasis on network security, Allied Telesis solutions can help protect against unauthorized network access, ensuring critical financial data and records are kept secure.



Industry

Industrial networking has its own unique set of requirements requiring products and solutions that ensure reliable fail-safe operation. Allied Telesis has a range of solutions that meet these requirements, based on fiber, copper and wireless technologies.



Retail

Reliable, low-cost, easily managed solutions are required by many retail organizations to ensure continued operation of the local stores, and complete management and accessibility from a central location. Allied Telesis provide complete solutions from point-of-sale connectivity, video surveillance, point-of-sale marketing and back office data warehousing.



Transportation

Transportation network systems from Allied Telesis provide high bandwidth realtime communication with moving vehicles, broadband access to passengers, video security of public vehicles, facilities and infrastructure, as well as monitoring of environmental conditions and traffic control. Our compatibility with credit card authorization allows implementation of remote ticket machines, in car-parks as well as train and bus stations.



Enterprises

Our multi-layer switch and router technology offers advanced features that ensure high-availability, manageability, security, adaptability and performance. Our intelligent, secure end-to-end IP network infrastructure scales to flexibly accommodate bandwidth-hungry voice, video and data applications into enterprises.



Small and Medium Business

Allied Telesis has one of the industry's most extensive product line-ups for small and medium-sized businesses seeking affordable and easy-to-deploy wired and wireless products for voice, video and data. Our switch, router, VoIP and wireless access solutions can be combined to deliver a high performance, feature-rich and flexible solution for a reliable and long-lasting network.



Discover the Advantages of Allied Telesis' PartnerPortal

If you are a reseller who wants to grow your business by reaching into new and existing markets, then we invite you to register on our PartnerPortal – your one-stop resource for taking a step ahead of the competition.

Not your typical partner site, PartnerPortal is more than half-hearted promos and empty promises. It is an interactive resource packed with design assistance, product support information and special promotions just for our portal partners.

PartnerPortal is flexible, offering you effortless access to our exclusive promotions and programs.

Why Should You Join PartnerPortal?

PartnerPortal is your secure 24-hour resource for Allied Telesis product information, promotional programs and special pricing deals. Register today to access these and other valuable tools to help you win bids and grow your business.



Product Selector

Looking for a replacement solution? Want to upgrade from a legacy product? Check out our complete array of product selector resources.

Product Support

Our extensive 'Support' section offers detailed information, tools, images and specifications on Allied Telesis products, services and solutions.

Promotions

From standard rebates and bundles to buy/get offers, portal partners save with promotions and special pricing on switches, routers, media converters and more!

Competitive Analysis

Need to convert a competitive part number? Use our expertise to select the correct product against those offered by our competition.

Register and start winning business today

In Europe, please register at <http://partnerportal.alliedtelesis.co.uk>

For the US and Latin America, please register at <http://partnerportal.alliedtelesis.com>



Global Service & Support Programs

Net.Cover® Service and Support Programs

Allied Telesis offers service and support programs to protect your network infrastructure investment. These services are designed to augment the coverage offered by Allied Telesis' warranties.

- Net.Cover
- Net.Professional Services
- Allied Campus

These service and support programs may not be available in all regions. Contact your local sales office for more information.



Net.Cover

Allied Telesis' Net.Cover is a comprehensive service and support program designed to protect vital network systems from unscheduled downtime. This comprehensive service array includes features such as multi-level technical phone support, priority queuing, and advanced product replacement. Net.Cover services include:

- Online knowledge base
- Software updates with proactive change notification
- Next business day advanced product replacement
- Priority queuing and escalation
- Configuration assistance
- No out-of-warranty expenses

Renewable Net.Cover contracts run for one, three or five years. Custom contracts are available upon request. Contact your local sales office for more information.



Allied Campus

Allied Telesis creates a wealth of training material designed to help its customers to better design, implement and maintain their networks. Courses are designed to cater for a range of technical ability and networking experience. Anyone who sells, installs, maintains or troubleshoots and supports Allied Telesis products will find these courses invaluable.

Each course incorporates a hands-on laboratory session with instructor led training in a comfortable environment that simulates real network issues. When you pass each course, you will receive a certificate that allows you to attend the more advanced courses or specialist courses, and gain easy access to Allied Telesis' internal support engineers.



Net.Professional Services

Allied Telesis has assembled a team of highly trained, experienced network engineers and project managers to help you design, integrate, deploy, and manage increasingly complex converged IP networks. Our engineering services encompass all aspects of network development, from network design and deployment, to management and integration. We use proven, tested gate and acceptance processes that ensure a smooth initial deployment, error free integration, and seamless change management.

Service and Support Contact Information

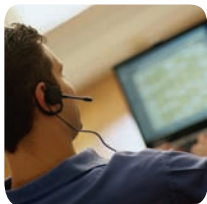

Allied Telesis Technical Support:

<http://support.alliedtelesis.com>
<http://www.alliedtelesis.com/support>

General Service and Support Enquiries:

services@alliedtelesis.com



Unmanaged Switches

Unmanaged Switches



		FAST ETHERNET			
SUBCATEGORY	FEATURE	AT-FS705LE	AT-FS705L	AT-FS705EFC	AT-FS708LE
FORM FACTOR		» Wallmountable » Desktop	» Wallmountable » Desktop	» Wallmountable » Desktop	» Wallmountable » Desktop
PORTS AND MEDIA SUPPORT	10/100TX	5	5	4	8
	100FX SFP (1000Mbps)			1 x SC, MMF	
POWER SUPPLY		External (Energy Star)	Internal	External (Energy Star)	External (Energy Star)
POWER OVER ETHERNET	IEEE 802.3af				
	PoE enabled ports				
	Max number of full power ports				
	Mode PoE power				
SCALABILITY	MAC address table size	2K	2K	4K	4K
ENVIRONMENTAL	Cooling	Fanless	Fanless	Fanless	Fanless
	ECO-Switch technology	■	■	■	■
DIMENSIONS	(W x D x H)	11.6 x 7 x 2.5cm 4.56 x 2.77 x 1in	16 x 11.6 x 3.5cm 6.3 x 4.6 x 1.4in	17.9 x 9.8 x 1.7cm 7.04 x 3.85 x .67in	13 x 7 x 2.5cm 5.12 x 2.77 x 1in
	Weight	.224kg / .49lbs	.5kg / 1.10lbs	.36kg / .79lbs	.266kg / .6lbs
IDEAL ENVIRONMENT		» Small home / office networks » Extend edge of larger network	» Small home / office networks » Extend edge of larger network	» Edge switch on fiber-based network	» Small home / office networks » Extend edge of larger network
CUSTOMER'S NEEDS		» Small or no IT » Cost effective » Simple to install	» Small or no IT » Cost effective » Simple to install	» Interface to fiber backbone network » Longer than 100m cable runs » Cost effective » Simple to install	» Small or no IT » Cost effective » Simple to install



		GIGABIT ETHERNET			
SUBCATEGORY	FEATURE	AT-GS900/5E	AT-GS900/8E	AT-GS900/8	AT-GS900/16
FORM FACTOR		» Wallmountable » Desktop	» Wallmountable » Desktop	» Wallmountable » Desktop » Rackmountable	» Wallmountable » Desktop » Rackmountable
PORTS AND MEDIA	10/100/1000T	5	8	8	16
POWER SUPPLY		External (Energy Star)	External (Energy Star)	Internal	Internal
SCALABILITY	MAC address table size	4K	4K	4K	8K
ENVIRONMENTAL	Cooling	Fanless	Fanless	Fanless	Fanless
	ECO-Switch technology	■	■		
DIMENSIONS	(W x D x H)	17.1 x 9.8 x 2.8cm 6.73 x 3.86 x 1.1in	17.1 x 9.8 x 2.8cm 6.73 x 3.86 x 1.1in	24.9 x 11.4 x 3.8cm 9.8 x 4.49 x 1.5in	33 x 23.1 x 4.4cm 13 x 9.09 x 1.73in
	Weight	.37kg / .81lbs	.389kg / .857lbs	.9kg / 1.98lbs	2.38kg / 5.24lbs
IDEAL ENVIRONMENT		» Small home / office networks » Extend edge of larger network	» Small home / office networks » Extend edge of larger network	» Small home / office networks » Extend edge of larger network	» Small home / office networks » Extend edge of larger network
CUSTOMER'S NEEDS		» High performance » Small or no IT » Cost effective » Simple to install	» High performance » Small or no IT » Cost effective » Simple to install	» High performance » Small or no IT » Cost effective » Simple to install	» High performance » Small or no IT » Cost effective » Simple to install

Unmanaged switches are simple to deploy, as they require no user setup, making them the idea product for SOHO (Small Office, Home Office) applications. Their silent operation, and eco-friendly low power operation ensures both minimal running costs, and no intrusive noise.

Eco-friendly

Our eco-friendly models use a variety of methods to reduce power, and thus help save the planet whilst reducing energy costs. All our eco-friendly models use highly efficient power supplies which reduce the amount of heat generated. Ethernet ports which are inactive are placed into power saving modes, and even active ports measure the distance of the attached cables, and drive just the correct amount of power. All these improvements result in power consumption being reduced by 50% over previous models.





Unmanaged Switches

FAST ETHERNET						
	AT-FS708	AT-FS708/POE	AT-FS709FC	AT-FS716L	AT-FS717FC	AT-FS724L
	» Wallmountable » Desktop » Rackmountable	» Wallmountable » Desktop » Rackmountable	» Wallmountable » Desktop » Rackmountable	» Wallmountable » Desktop » Rackmountable	» Desktop » Rackmountable	» Wallmountable » Desktop » Rackmountable
	8	8	8	16	16	24
		1	1 x SC. MMF		1 x SC. MMF	
	Internal	Internal	Internal	Internal	Internal	Internal
		■ 8 4 A 65W				
	1K	8K	4K	8K	4K	8K
	Fanless	Fanless	Fanless	Fanless	Fanless	Fanless
	■	■		■		■
	24.9 x 11.6 x 3.6cm 9.8 x 4.56 x 1.42in	33 x 22 x 4.3cm 13 x 8.7 x 1.7in	22 x 12 x 3.6cm 8.66 x 4.72 x 1.42in	24.9 x 11.6 x 3.6cm 9.8 x 4.6 x 1.4in	29.5 x 11.5 x 4cm 11.61 x 4.52 x 1.57in	28 x 18 x 4.4cm 11 x 7.1 x 1.7in
	.9kg / 1.98lbs	1.9kg / 4.20lbs	2kg / 4.4lbs	.9kg / 1.98lbs	.93kg / 2.05lbs	1.59kg / 3.51lbs
	» Small home / office networks » Extend edge of larger network	» Small office network with wireless, IP cameras	» Edge switch on fiber-based network	» Small office network	» Edge switch on fiber-based network	» Small office network
	» Small or no IT » Cost effective » Simple to install	» Ability to power wireless access points, cameras, etc. » Interface to fiber backbone network » Longer than 100m cable runs » Cost effective » Simple to install	» Interface to fiber backbone network » Longer than 100m cable runs » Cost effective » Simple to install	» Small or no IT » Cost effective » Simple to install	» Interface to fiber backbone network » Longer than 100m cable runs » Cost effective » Simple to install	» Small or no IT » Cost effective » Simple to install



GIGABIT ETHERNET	
AT-GS900/24	
	» Wallmountable » Desktop » Rackmountable
	24
	Internal
	8K
	Fanless
	33 x 23.1 x 4.4cm 13 x 9.09 x 1.73in
	2.99kg / 6.6lbs
	» Small home / office networks » Extend edge of larger network
	» High performance » Small or no IT » Cost effective » Simple to install

Auto-negotiation and Auto MDI/MDI-X

All our unmanaged copper switch ports support auto-negotiation and auto MDI/MDI-X, enabling them to interface with legacy Ethernet and Fast Ethernet products, without the need for special cables, or user configuration.

Fanless Designs

All Allied Telesis unmanaged switches feature fanless design, allowing use in home and small office installations.



Powered by an ENERGY STAR® qualified adapter for a better environment



Notes



WebSmart Switches



WebSmart Switches

		FAST ETHERNET			
SUBCATEGORY	FEATURE	AT-FS750/16	AT-FS750/24	AT-FS750/24POE	AT-FS750/48
FORM FACTOR		» Desktop » Rackmountable	» Desktop » Rackmountable	» Wallmountable » Desktop » Rackmountable	» Wallmountable » Desktop » Rackmountable
PORTS AND MEDIA SUPPORT	I0/I00TX	16	24	24	48
	I0/I00/I000T	2 (combo)	2 (combo)	2 (combo)	2
	SFP	2 (combo)	2 (combo)	2 (combo)	2
	I00FX SFP support	■	■	■	
POWER SUPPLY		Internal	Internal	Internal	Internal
POWER OVER ETHERNET	IEEE 802.3af			■	
	PoE enabled ports			12	
	Max number of full power ports			6	
	Mode			A	
	PoE power			100W	
SCALABILITY	MAC address table size	8K	8K	8K	8K
ENVIRONMENTAL	Cooling	Fanless	Fanless	Fan	Fan
	ECO-Switch technology			■	■
MANAGEMENT	Web	■	■	■	■
	CLI	■	■		
	SNMPv1 / v2	■	■	■	■
NETWORK RESILIENCE	Spanning-Tree	■	■	■	■
	Rapid Spanning-Tree	■	■	■	■
	Link aggregation (LACP)	■	■	■	■
	IGMP snooping (v1 / v2)	■	■	■	■
	Port setting (speed, availability, flow control)	■	■	■	■
QoS	IEEE 802.1p priority queues	4	4	4	4
SECURITY	IEEE 802.1Q VLANs	256	256	256	256
	IEEE 802.1x	■	■	■	■
	RADIUS / DHCP client	■	■	■	■
OTHER	Jumbo frames (9K)			■	■
	Port mirroring	■	■	■	■
	MAC filtering / ingress/egress rate limiting / broadcast storm control	■	■	■	■
DIMENSIONS	(W x D x H)	35.2 x 25.6 x 4.3cm 13.85 x 10 x 1.7in	44 x 25.7 x 4.3cm 17.3 x 10.1 x 1.7in	44 x 25.7 x 4.3cm 17.3 x 10.1 x 1.7in	44 x 25.7 x 4.3cm 17.3 x 10.1 x 1.7in
	Weight	2.38kg / 5.24lbs	3.24kg / 7.14lbs	4.133kg / 9.11lbs	3.79kg / 8.35lbs
IDEAL ENVIRONMENT		» Classroom » Home office » SMB » Security at the edge	» Classroom » Home office » SMB » Security at the edge	» Classroom » Home office » SMB » Security at the edge	» Classroom » Home office » SMB » Security at the edge
CUSTOMER'S NEEDS		» Management at the edge » Basic, entry level, security » Web-based management » Copper Ethernet at the edge of the fiber network	» Management at the edge » Basic, entry level, security » Web-based management » Copper Ethernet at the edge of the fiber network	» Low-cost Power over Ethernet » Management at the edge » Basic, entry level, security » Web-based management » Copper Ethernet at the edge of the fiber network	» Management at the edge » Basic, entry level, security » Web-based management » Copper Ethernet at the edge of the fiber network

WebSmart switches provide a dual role in providing connectivity for computer networks. For small office networks, they provide security and data priority, allowing Voice over IP and similar applications to be deployed. In larger networks, WebSmart switches provide high levels of security, authentication and data priority, but at a lower cost point than a fully managed device.

Simple Configuration

WebSmart switches can be used straight from the box with no configuration required. The additional features can be enabled via the simple Graphical User Interface (GUI) management interface, allowing less technical users to configure the devices.



WebSmart Switches

GIGABIT ETHERNET				
AT-GS950/8	AT-GS950/8POE	AT-GS950/16	AT-GS950/24	AT-GS950/48
» Wallmountable » Desktop » Rackmountable	» Wallmountable » Desktop » Rackmountable	» Desktop » Rackmountable	» Desktop » Rackmountable	» Wallmountable » Desktop » Rackmountable
8	8	16	24	48
2 (combo)	2 (combo)	2 (combo)	2 (combo)	4 (combo)
Internal	Internal	Internal	Internal	Internal
	4 4 B 60W			
4K	8K	8K	8K	8K
Fanless	Fanless	Fan	Fan	Fan
■	■	■	■	■
■	■	■	■	■
■	■	■	■	■
■	■	■	■	■
■	■	■	■	■
4	4	4	4	4
32	256	256	256	256
Pass-through	■	■	■	■
■	■	■	■	■
■	■	■	■	■
	■	■	■	■
28 x 17.9 x 4.3cm 11 x 7 x 1.7in 1.61kg / 3.5lbs	32 x 23 x 4.3cm 13 x 9.1 x 1.7in 2.54kg / 5.6lbs	35.2 x 25.6 x 4.3cm 13.85 x 10 x 1.7in 2.38kg / 5.24lbs	44 x 25.7 x 4.3cm 17.3 x 10.1 x 1.7in 3.24kg / 7.14lbs	44 x 25.7 x 4.3cm 17.3 x 10.1 x 1.7in 4.05kg / 8.92lbs
» Classroom » Home office » SMB » Security at the edge	» Classroom » Home office » SMB » Security at the edge	» Classroom » Home office » SMB » Security at the edge	» Classroom » Home office » SMB » Security at the edge	» Classroom » Home office » SMB » Security at the edge
» Management at the edge » Basic, entry level, security » Web-based management » Copper Ethernet at the edge of the fiber network	» Low-cost Power over Ethernet » Management at the edge » Basic, entry level, security » Web-based management » Copper Ethernet at the edge of the fiber network	» Management at the edge » Basic, entry level, security » Web-based management » Copper Ethernet at the edge of the fiber network	» Management at the edge » Basic, entry level, security » Web-based management » Copper Ethernet at the edge of the fiber network	» Management at the edge » Basic, entry level, security » Web-based management » Copper Ethernet at the edge of the fiber network

Affordable Solutions

WebSmart switches offer a solution with key 'managed switch' features – yet without the price tag normally associated with managed switches.

The switches are perfect for budget-constrained companies looking for advanced features like Quality of Service (QoS), port mirroring, Virtual LAN (VLAN) and Power over Ethernet (PoE). In addition, WebSmart switches can be used on the edge of a large managed network whilst still providing high levels of security, as the backbone network will provide all the client authentication.



Notes



Power over Ethernet Switches



Power over Ethernet Switches

SUBCATEGORY	FEATURE	AT-FS708/POE	AT-FS750/24POE	AT-GS950/8POE	AT-8000/8POE
FORM FACTOR		» Wallmountable » Desktop » Rackmountable	» Wallmountable » Desktop » Rackmountable	» Wallmountable » Desktop » Rackmountable	» Wallmountable » Desktop » Rackmountable
SWITCH FUNCTIONALITY		Unmanaged	WebSmart	WebSmart	Layer 2
PORTS AND MEDIA SUPPORT	10/100TX	8	24	8	8
	10/100/1000T		2	8	1 (combo)
	SFP	1 1000Mbps	2 (combo) 100 or 1000Mbps	2 (combo) 100 or 1000Mbps	1 1000Mbps
	Modular uplinks				
MODULAR UPLINKS	1 x 100FX				
POWER SUPPLY	PSU type	Fixed internal	Fixed internal	Fixed internal	Fixed internal
	Redundant PSU option				
	Redundant PSU chassis (inc 1 PSU)				
	Additional redundant PSU				
POWER OVER ETHERNET	IEEE 802.3af	■	■	■	■
	PoE enabled ports	8	12	4	8
	Max number of full power ports	4	6	4	6
	Mode	A	A	B	B
	PoE power	65W	100W	60W	95W
SCALABILITY	MAC address table size	8K	8K	8K	8K
	Stacking				
ENVIRONMENTAL	Cooling	Fanless	Fan	Fanless	Fan
	ECO-Switch technology	■	■		
MANAGEMENT	Web		■	■	
	CLI				■
	Telnet				■
	SNMP		■	■	■
NETWORK RESILIENCE	Spanning-Tree		■	■	■
	Link aggregation (LACP)		■	■	
QoS	IEEE 802.1p priority queues		4	4	
SECURITY	IEEE 802.1Q VLANs		256	256	256
	RADIUS		■	■	
	TACACS				
	SSH/SSL				
	IEEE 802.1x		■	■	
	DoS protection				
ROUTING					
DIMENSIONS	(W x D x H)	27 x 16 x 4.3cm 10.6 x 6.3 x 1.7in	44 x 25.7 x 4.3cm 17.3 x 10.1 x 1.7in	32 x 23 x 4.3cm 13 x 9.1 x 1.7in	33 x 22.8 x 4.3cm 13 x 8 x 1.7in
	Weight	1.77kg / 3.9lbs	4.133kg / 9.11lbs	2.54kg / 5.6lbs	2.2kg / 4.9lbs

Power over Ethernet allows a copper Ethernet cable to provide power as well as data connectivity to a remote device. This device could be a VoIP phone, a security camera, or a wireless access point. Allied Telesis offers a range of PoE switch products delivering all the switching functionality needed for the network, plus power to PoE capable connected devices. Using PoE devices alleviates the need to provide power at the remote end of the data link.

How Much Power?

The IEEE 802.3af Power over Ethernet standard allows for any Power Sourcing Equipment (PSE) to provide up to 15.4Watts of power to the Powered Devices (PD, or the end-point). The amount of power drawn is classified in the following table. A port connected to a network node that is not a Powered Device (that is, a device that receives its power from another power source) functions as a regular Ethernet port, without PoE. The PoE feature remains enabled on the port but no power is delivered to the device.

Class	Usage	Min. Power Levels Output at the PSE	Max. Power Levels Output at the PD
0	Default	15.4W	0.44W to 12.95W
1	Optional	4.0W	0.44W to 3.84W
2	Optional	7.0W	3.84W to 6.49W
3	Optional	15.4W	6.49W to 12.95W

Power Budget

Users should ensure that the maximum power drawn by all the attached Powered Devices (PDs) should not exceed the maximum power that can be delivered by the Power Sourcing Equipment (PSE, or switch). Should this occur, then the switch will use a predetermined algorithm to determine which ports get power and which ports do not get power (see user manuals for exact details on each switch).



	AT-8000S/24POE	AT-8000S/48POE	AT-8624POE	AT-8000GS/24POE	AT-9424T/POE	AT-x600-24Ts-POE
	» Desktop » Rackmountable » Stackable	» Desktop » Rackmountable » Stackable	» Desktop » Rackmountable	» Desktop » Rackmountable » Stackable	» Desktop » Rackmountable	» Desktop » Rackmountable » Stackable
	Layer 2	Layer 2	Layer 3	Layer 2	Layer 3	Layer 3
	24	48	24	24	24	24
	2	2	2	24	24	24
	2 (combo) 100 or 1000Mbps	2 (combo) 100 or 1000Mbps	2 (combo) 1000Mbps	4 (combo) 100 or 1000Mbps	4 (combo) 1000Mbps	4 (combo) 1000Mbps
			2 AT-A45			
	Fixed internal	Fixed internal	Fixed internal	Fixed internal	Fixed internal	Fixed internal
			■ AT-RPS3104 AT-PWR3101			■ AT-RPS3104 AT-PWR3101
	■	■	■	■	■	■
	24	48	24	24	24	24
	12	24	24	9	24	24
	B	B	A			
	180W	375W	400W	140W	370W	370W
	8K	8K	8K	8K	16K	16K
	■ (6)	■ (6)		■ (6)		■ AT-STACXXG (4)
	Fan	Fan	Fan	Fan	Fan	Fan
	■	■	■	■	■	■
	■	■	■	■	■	■
	■	■	■	■	■	■
	■	■	■	■	■	■
	■	■	■	■	■	■
	■	■	■	■	■	■
	4	4	4	4	8	8
	256	256	256	4096	4096	4096
	■	■	■	■	■	■
	■	■	■	■	■	■
	■	■	■	■	■	■
	■	■	■	■	■	■
	■	■	■	■	■	■
	44 x 25.7 x 4.3cm 17.3 x 10.1 x 1.7in	44 x 34.7 x 4.3cm 17.3 x 13.7 x 1.7in	43.8 x 40.6 x 4.4cm 17.24 x 15.98 x 1.73in	44 x 25.7 x 4.3cm 17.3 x 10.1 x 1.7in	44 x 40.8 x 4.4cm 17.3 x 16.1 x 1.73in	44 x 40.8 x 4.4cm 17.3 x 16.1 x 1.73in
	3.7kg / 8.15lbs	5.6kg / 12.34lbs	6kg / 13.22lbs	3.5kg / 7.71lbs	6.17kg / 13.6lbs	6.90kg / 15.2lbs (unpackaged)

Cable Types

Power over Ethernet is designed to run over existing standard Ethernet cables. However, for Fast Ethernet there are two modes of operation.

Mode A – Injects power onto the data wires

Mode B – Uses ‘spare pairs’ to transmit the power

Gigabit copper connections use all four pairs to connect.

Power Injectors

Allied Telesis also has a power injector and power splitter which can be used to inject or extract power over a single UTP connection (see page 42).

- AT-6101G Power injector
- AT-6102G Power splitter



Notes



Fast Ethernet Switches



Fast Ethernet Switches

SUBCATEGORY	FEATURE	AT-8000/8POE	AT-8000S/16	AT-8000S/24	AT-8000S/24POE	AT-8000S/48
FORM FACTOR		» Wallmountable » Desktop » Rackmountable	» Desktop » Rackmountable » Stackable	» Desktop » Rackmountable » Stackable	» Desktop » Rackmountable » Stackable	» Desktop » Rackmountable » Stackable
SWITCH FUNCTIONALITY		Layer 2	Layer 2	Layer 2	Layer 2	Layer 2
PORTS AND MEDIA SUPPORT	10/100TX	8	16	24	24	48
	10/100/1000T	1 (combo)	1 (combo)	2 (combo)	2 (combo)	2 (combo)
	100FX					
	SFP	1 1000Mbps	1 (combo) 100 or 1000Mbps	2 (combo) 100 or 1000Mbps	2 (combo) 100 or 1000Mbps	2 (combo) 100 or 1000Mbps
	Modular uplinks					
MODULAR UPLINKS	1 x 1000T					
	1 x GBIC					
	1 x 100FX					
POWER SUPPLY	PSU type	Fixed internal	Fixed internal	Fixed internal	Fixed internal	Fixed internal
	-48VDC PSU option					
	Redundant PSU option					
	Redundant PSU chassis (inc 1 PSU)					
	Additional redundant PSU					
POWER OVER ETHERNET	IEEE 802.3af	■			■	
	PoE enabled ports	8			24	
	Max number of full power ports	6			12	
	Mode	B			B	
	PoE power	95W			180W	
SCALABILITY	MAC address table size	8K	8K	8K	8K	8K
	Stacking		■ (6)	■ (6)	■ (6)	■ (6)
ENVIRONMENTAL	Cooling	Fan	Fanless	Fanless	Fan	Fan
	Temperature range (°C)	0°C to 40°C	0°C to 40°C	0°C to 40°C	0°C to 40°C	0°C to 40°C
MANAGEMENT	Web		■	■	■	■
	CLI / Telnet / SNMP	■	■	■	■	■
NETWORK RESILIENCE	Spanning-Tree	■	■	■	■	■
	Link aggregation (LACP)		■	■	■	■
	EPSR					
QoS	IEEE 802.1p priority queues	4	4	4	4	4
SECURITY	IEEE 802.1Q VLANs	256	256	256	256	256
	Guest VLANs		■	■	■	■
	RADIUS / SSH/SSL / IEEE 802.1x		■	■	■	■
	DoS protection					
ROUTING	RIPv1 and v2					
	IPv4					
	IPv6					
	OSPFv2 / VRRP					
DIMENSIONS	(W x D x H)	33 x 22.8 x 4.3cm 13 x 8 x 1.7in	33 x 23 x 4.3cm 13 x 9.1 x 1.7in	44 x 25.7 x 4.3cm 17.3 x 10.1 x 1.7in	44 x 25.7 x 4.3cm 17.3 x 10.1 x 1.7in	44 x 25.7 x 4.3cm 17.3 x 10.1 x 1.7in
	Weight	2.2kg / 4.9lbs	1.95kg / 4.29lbs	3.15kg / 6.94lbs	3.7kg / 8.15lbs	3.38kg / 7.45lbs

Security

IEEE 802.1x Authentication

This protocol uses an authentication server to store details of each user who has been granted access to the network. The authentication criteria can be a computer MAC address, but can also include IP address, username and password etc. Initially, the switch port will be blocked, but when a computer connects, it will only be connected to the authentication server. If the request to access the network is granted, then the switch will be programmed with the necessary details, such as VLAN membership. This type of security simplifies the task of the network administrator. They can keep all of their security data on a server and not have to program each switch. It has the added benefit of allowing the users to connect to any port on the network.

Denial of Service Attack

A DoS attack is a hacker's way of by-passing security on a network. The basic premise is to overload the CPU inside the switch, causing the switch to fail in the tasks that it needs to perform. In this vulnerable state, it is then easier for the hacker

to gain entry onto the network. Switches that support DoS protection can identify when an attack is taking place, and can then cut off the offending traffic. This maintains the integrity of the remainder of the network.

Guest VLANs

Switches with Guest VLAN functionality provide a highly effective means of providing DMZ-like functionality on a Layer 2 network by separating private and public resources. Access to private resources requires successful IEEE 802.1x authentication, but access to public resources (like Internet access) are available to guests who otherwise will not successfully authenticate or do not have an IEEE 802.1x client. This allows organizations to provide hospitable connectivity to visitors without letting them freely roam the network.

Traffic Segmentation

In order to isolate network traffic between different workgroups, a network can be segmented into Virtual LANs (VLANs). These VLANs provide all the benefits of separate physical networks,



Fast Ethernet Switches



	AT-8000S/48POE	AT-8516F/SC	AT-8624T/2M	AT-8624POE	AT-8648T/2SP	AT-x900-48FE	AT-x900-48FS
	» Desktop » Rackmountable » Stackable	» Desktop » Rackmountable	» Desktop » Rackmountable	» Desktop » Rackmountable	» Desktop » Rackmountable	» Desktop » Rackmountable	» Desktop » Rackmountable
	Layer 2	Layer 2+	Layer 3	Layer 3	Layer 3	Advanced Layer 3	Advanced Layer 3
	48		24	24	48	48	
	2 (combo)		2		2 (combo)		
		16 (SC)					
	2 (combo) 100 or 1000Mbps		2 (combo) 1000Mbps	2 (combo) 1000Mbps	2 (combo) 1000Mbps	4 (1000Mbps)	48 (100Mbps) 4 (1000Mbps)
		2	2	2			
		AT-A46					
		AT-A47					
		AT-A45	AT-A45	AT-A45			
	Fixed internal	Fixed internal	Fixed internal	Fixed internal	Fixed internal	Hot swap internal	Hot swap internal
		■	■	■	■	■	■
		AT-RPS3004	AT-RPS3004	AT-RPS3104	AT-RPS3004		
		AT-PWR3004	AT-PWR3004	AT-PWR310I	AT-PWR3004	AT-PWR01 (AC or DC)	AT-PWR02 (AC) AT-PWR01 (DC)
	■			■			
	48			24			
	24			24			
	B			A			
	375W			400W			
	8K	8K	8K	8K	8K	16K	16K
	■ (6)						
	Fan	Fan	Fan	Fan	Fan	Hot swappable fan module	Hot swappable fan module
	0°C to 40°C	0°C to 40°C	0°C to 40°C	0°C to 40°C	0°C to 40°C	0°C to 50°C	0°C to 50°C
	■	■	■	■	■	■	■
	■	■	■	■	■	■	■
	■	■	■	■	■	■	■
	■	■	■	■	■	■	■
	4	4	4	4	4	8	8
	256	256	256	256	256	4096	4096
	■	■	■	■	■	■	■
	■	■	■	■	■	■	■
						■	■
						■	■
						■	■
						■	■
						■	■
						■	■
	44 x 34.7 x 4.3cm 17.3 x 13.7 x 1.7in	43.8 x 18.4 x 4.4cm 17.24 x 7.24 x 1.73in	43.8 x 22.2 x 4.4cm 17.24 x 8.7 x 1.73in	43.8 x 40.6 x 4.4cm 17.24 x 15.98 x 1.73in	43.8 x 26.16 x 4.4cm 17.24 x 10.3 x 1.73in	44 x 44 x 4.4cm 17.3 x 17.3 x 1.73in	44 x 44 x 4.4cm 17.3 x 17.3 x 1.73in
	5.6kg / 12.34lbs	3.5kg / 7.6lbs	3.3kg / 7.27lbs	6kg / 13.22lbs	3.6kg / 7.94kg	7.61kg (with 1 PSU) / 16.78lbs	7.61kg (with 1 PSU) / 16.78lbs

allowing secure connectivity for multiple departments over a common physical infrastructure. Within the IEEE standard, Allied Telesis has designed a range of switches with appropriate VLAN support for specific applications from the edge to the core of the network.

Quality of Service (QoS)

In converged voice, video and data networks or in networks where data traffic includes time critical application data, packet prioritization becomes a key factor in efficient network operations. Packet prioritization can be achieved by having a switch define the Quality of Service (QoS) required by different data streams. Voice packets, for example, must be given the highest priority in a converged network in order to produce high quality, unbroken audio reproduction. Voice packets can be given a higher priority and will therefore be forwarded by network devices ahead of less important time sensitive traffic such as e-mail. The IEEE standard for QoS allows up to eight different levels of prioritization.



Notes



Gigabit Edge / Agg Switches



SUBCAT	FEATURE	AT-9000/28	AT-9000/28SP	AT-9000/52	AT-8000GS/24	AT-8000GS/24POE	AT-8000GS/48	AT-9408LC
FORM FACTOR		» Desktop » Rackmountable	» Desktop » Rackmountable	» Desktop » Rackmountable	» Desktop » Rackmountable » Stackable	» Desktop » Rackmountable » Stackable	» Desktop » Rackmountable » Stackable	» Desktop » Rackmountable
SWITCH FUNCTIONALITY		Layer 2	Layer 2	Layer 2	Layer 2	Layer 2	Layer 2	Layer 2+
PORTS AND MEDIA SUPPORT	I0/100/1000T	24	24	48	24	24	48	
	SFP	4 100 or 1000Mbps	4 (combo) 100 or 1000Mbps	4 (combo) 100 or 1000Mbps	4 (combo) 100 or 1000Mbps	4 (combo) 100 or 1000Mbps	4 (combo) 100 or 1000Mbps	4 1000Mbps
	Fixed 1000SX (MMF) Fixed XFP (10GbE)							8
POWER SUPPLY	PSU type	Fixed internal	Fixed internal	Fixed internal	Fixed internal	Fixed internal	Fixed internal	Fixed internal
	-48vDC PSU option							
	Redundant PSU option							■
	Redundant PSU chassis (inc 1 PSU) Additional redundant PSU							AT-RPS3204 AT-PWR3202
POWER OVER ETHERNET	PoE enabled ports					24		
	Max no. of full power ports					9		
	PoE power					140W		
SCALABILITY	MAC address table size	8K	8K	8K	8K	8K	8K	16K
	Stacking	■ *	■ *	■ *	■ (6)	■ (6)	■ (6)	
ENVIRONMENTAL	Cooling	Fanless	Fan	Fan	Fan	Fan	Fan	Fan
	ECO-Switch technology Temperature range (°C)	■ 0°C to 40°C	■ 0°C to 40°C	■ 0°C to 40°C	■ 0°C to 40°C	■ 0°C to 40°C	■ 0°C to 40°C	■ 0°C to 40°C
MANAGEMENT	Web	■	■	■	■	■	■	■
	CLI / Telnet / SNMP	■	■	■	■	■	■	■
	IPv6	■	■	■	■	■	■	■
NETWORK RESILIENCE	Spanning-Tree	■	■	■	■	■	■	■
	Link aggregation (LACP)	■	■	■	■	■	■	■
	EPSR							
QoS	IEEE 802.1p priority queues	8	8	8	4	4	4	8
SECURITY	IEEE.802.1Q VLANs	4096	4096	4096	4096	4096	4096	4096
	RADIUS / IEEE 802.1x	■	■	■	■	■	■	■
	TACACS	■	■	■	■	■	■	■
	SSH/SSL	■	■	■	■	■	■	■
	DoS protection							■
ROUTING	RIPv1 and v2 / IPv4							
	IPv6							
	OSPFv2 / VRRP							
	ECMP							
DIMENSIONS	(W x D x H)	44 x 25.7 x 4.3cm 17.3 x 10.1 x 1.7in	44 x 25.7 x 4.3cm 17.3 x 10.1 x 1.7in	44 x 25.6 x 4.3cm 17.3 x 10 x 1.7in	44 x 25.7 x 4.3cm 17.3 x 10.1 x 1.7in	44 x 25.7 x 4.3cm 17.3 x 10.1 x 1.7in	44 x 25.7 x 4.3cm 17.3 x 10.1 x 1.7in	44 x 22.2 x 4.4cm 17.3 x 8.7 x 1.73in
	Weight	3.61kg / 7.95lbs	4.01kg / 8.85lbs	4.06kg / 8.95lbs	3.15kg / 6.94lbs	3.50kg / 7.71lbs	3.38kg / 7.45lbs	3kg / 6.6lbs

Network Resilience

Many business critical networks deploy devices that are resilient to power and other network related failures. Redundant power supplies and cooling fans enhance the availability of individual network devices, while UPS and backup generators protect against power outages. Advanced software features protect against device, port, or cable failures by intelligently re-routing data flows via redundant paths. These traditional features include Spanning-Tree, Rapid Spanning-Tree, Multiple Spanning-Tree and Virtual Router Redundancy Protocol (VRRP).

Ethernet Protected Switched Rings (EPSR)

Putting a ring of Ethernet switches at the core of a network is a simple way to increase the network's resilience—such a network is no longer susceptible to a single point of failure.



Traditionally, Spanning-Tree based technologies are used to protect rings, but they are relatively slow to recover from link failure. This can create problems for applications that have strict

loss requirements, such as voice and video traffic, where the speed of recovery is highly significant. EPSR provides high-speed (<50ms) reconfigurations in the event of a failure, ensuring no noticeable loss of service in these types of installation.

Dual Core Networking

Traditional core switches provide resilience by having one chassis actively running, whilst a second sits in standby. Users therefore pay for two chassis, but only ever get the throughput and performance of a single chassis. A range of Allied Telesis switches with Virtual Chassis Stacking (VCStack™) allow both core switches to actively pass traffic, with one also being the backup in the event of a failure. Thus for the majority of the time, users benefit from twice the performance of a traditional core network.





Gigabit Aggregation / Core Switches



SUBCATEGORY	FEATURE	AT-x600-24Ts	AT-x600-24Ts-POE	AT-x600-24Ts/XP	AT-x600-48Ts
FORM FACTOR		» Desktop » Rackmountable » Stackable	» Desktop » Rackmountable » Stackable	» Desktop » Rackmountable » Stackable	» Desktop » Rackmountable » Stackable
SWITCH FUNCTIONALITY		Advanced Layer 3	Advanced Layer 3	Advanced Layer 3	Advanced Layer 3
PORTS AND MEDIA SUPPORT	10/100/1000T	24	24	24	44
	SFP	4 (combo) 1000Mbps	4 (combo) 1000Mbps	4 (combo) 1000Mbps	4 1000Mbps
	Modular uplinks Fixed XFP (10GbE)			2	
MODULAR UPLINKS	12 x 10/100/1000T				
	12 x SFP (100 or 1000Mbps)				
	1 x XFP 2 x XFP				
POWER SUPPLY	PSU type	Fixed internal	Fixed internal	Fixed internal	Fixed internal
	-48vDC PSU option				
	Redundant PSU option				
	Redundant PSU chassis (inc 1 PSU)	AT-RPS3204	AT-RPS3104	AT-RPS3204	AT-RPS3204
	Additional redundant PSU	AT-PWR3202	AT-PWR3101	AT-PWR3202	AT-PWR3202
POWER OVER ETHERNET	IEEE 802.3af		■		
	PoE enabled ports		24		
	Max no. of full power ports		24		
	PoE power		370W		
SCALABILITY	MAC address table size	16K	16K	16K	16K
	Stacking	■ AT-STACKXG (4)	■ AT-STACKXG (4)	■ AT-STACKXG (4)	■ AT-STACKXG (4)
ENVIRONMENTAL	Cooling	Fan	Fan	Fan	Fan
	Temperature range (°C)	0°C to 40°C	0°C to 40°C	0°C to 40°C	0°C to 40°C
MANAGEMENT	Web	■	■	■	■
	CLI / Telnet / SNMP	■	■	■	■
NETWORK RESILIENCE	Spanning-Tree	■	■	■	■
	Link aggregation (LACP)	■	■	■	■
	EPSR	■	■	■	■
QoS	IEEE 802.1p priority queues	8	8	8	8
SECURITY	IEEE 802.1Q VLANs	4096	4096	4096	4096
	RADIUS / IEEE 802.1x	■	■	■	■
	SSH/SSL	■	■	■	■
	DoS protection	■	■	■	■
ROUTING	RIPv1 and v2 / IPv4	■	■	■	■
	IPv6	■	■	■	■
	OSPFv2 / VRRP	■	■	■	■
	ECMP	■	■	■	■
DIMENSIONS	(W x D x H)	44 x 30.5 x 4.4cm 17.3 x 12 x 1.73in	44 x 40.8 x 4.4cm 17.3 x 16.1 x 1.73in	44 x 30.5 x 4.4cm 17.3 x 12 x 1.73in	44 x 30.5 x 4.4cm 17.3 x 12 x 1.73in
	Weight	4.5kg / 9.9lbs (unpacked)	6.9kg / 15.2lbs (unpacked)	4.6kg / 10.1lbs (unpacked)	4.9kg / 10.8lbs (unpacked)

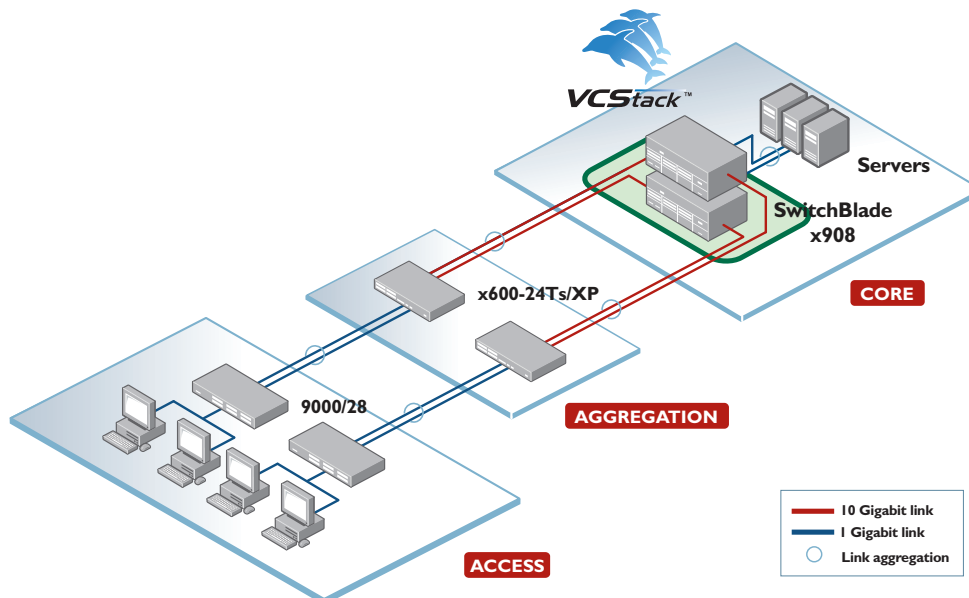



	AT-x600-48Ts/XP	AT-x900-12XT/S	AT-x900-24XT	AT-x900-24XS	AT-SBx908
	» Desktop » Rackmountable » Stackable	» Desktop » Rackmountable » Stackable	» Desktop » Rackmountable » Stackable	» Desktop » Rackmountable » Stackable	» Rackmountable » Stackable
	Advanced Layer 3	Advanced Layer 3	Advanced Layer 3	Advanced Layer 3	Advanced Layer 3
	44	12	24	24	8
	4 1000Mbps	12 (combo) 100 or 1000Mbps		24 100 or 1000Mbps	
	2	1	2	2	8
		AT-XEM-12T AT-XEM-12S AT-XEM-1XP AT-XEM-2XP	AT-XEM-12T AT-XEM-12S AT-XEM-1XP AT-XEM-2XP	AT-XEM-12T AT-XEM-12S AT-XEM-1XP AT-XEM-2XP	AT-XEM-12T AT-XEM-12S AT-XEM-1XP AT-XEM-2XP
	Fixed internal	Fixed internal	Hot swap internal	Hot swap internal	Hot swap internal
			■ ■	■ ■	■ ■
	AT-RPS3204				
	AT-PWR3202		AT-PWR01	AT-PWR01	AT-PWR05
	16K	16K	16K	16K	16K
	■ AT-STACKXG (4)	■ AT-XEM-STK (2)	■ AT-XEM-STK (2)	■ AT-XEM-STK (2)	■ Rear stacking (2)
	Fan	Fan	Hot swappable fan module	Hot swappable fan module	Hot swappable fan module
	0°C to 40°C	0°C to 40°C	0°C to 40°C	0°C to 40°C	0°C to 40°C
	■ ■ ■ ■	■ ■ ■ ■	■ ■ ■ ■	■ ■ ■ ■	■ ■ ■ ■
	8	8	8	8	8
	4096	4096	4096	4096	4096
	■ ■ ■ ■ ■ ■ ■ ■	■ ■ ■ ■ ■ ■ ■ ■	■ ■ ■ ■ ■ ■ ■ ■	■ ■ ■ ■ ■ ■ ■ ■	■ ■ ■ ■ ■ ■ ■ ■
	44 x 30.5 x 4.4cm 17.3 x 12 x 1.73in	44 x 35 x 4.4cm 17.3 x 13.8 x 1.73in	44 x 44 x 4.4cm 17.3 x 17.3 x 1.73in	44 x 44 x 4.4cm 17.3 x 17.3 x 1.73in	44 x 45.6 x 13.2cm 17.3 x 18 x 5.2in
	4.9kg / 10.8lbs (unpackaged)	5.3kg / 11.6lbs	7.3kg / 16.09lbs (with 1 PSU)	7.3kg / 16.09lbs (with 1 PSU)	14.32kg / 31.57lbs (no PSUs)

Aggregation and core switches provide the backbone to any large network, and therefore need to be reliable, resilient, with enough capacity and throughput to handle today's networks. Redundant power supplies ensure high availability, whilst VCStack and link aggregation provide resilience, ensuring access switches continue to achieve connectivity even in the event of a major failure.

IPv6 Management

All these switches support IPv6 management, ensuring that infrastructure installed today will support the networks for the future. With the number of global IPv4 addresses due to be exhausted at the end of 2010, investment today with IPv6 ready equipment is a necessity.

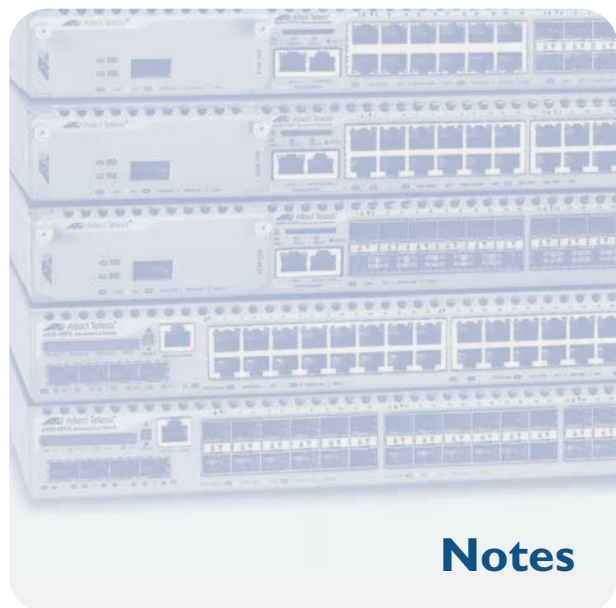

Gigabit Aggregation / Core Switches

Notes



10 Gigabit Switches



10 Gigabit Switches

SUBCATEGORY	FEATURE	AT-x600-24Ts/XP	AT-x600-48Ts/XP	AT-x900-12XT/S	AT-x900-24XT	
FORM FACTOR		» Desktop » Rackmountable » Stackable	» Desktop » Rackmountable » Stackable	» Desktop » Rackmountable » Stackable	» Desktop » Rackmountable » Stackable	
SWITCH FUNCTIONALITY		Advanced Layer 3	Advanced Layer 3	Advanced Layer 3	Advanced Layer 3	
PORTS AND MEDIA SUPPORT	10/100/1000T	24	44	12	24	
	100FX					
	SFP	4 (combo) 1000Mbps	4 1000Mbps	12 (combo) 100 or 1000Mbps		
	Modular uplinks			1	2	
MODULAR UPLINKS	Fixed XFP (10GbE)	2	2			
	12 x 10/100/1000T			AT-XEM-12T	AT-XEM-12T	
	12 x SFP			AT-XEM-12S	AT-XEM-12S	
	1 x XFP			AT-XEM-1XP	AT-XEM-1XP	
POWER SUPPLY	2 x XFP			AT-XEM-2XP	AT-XEM-2XP	
	PSU type	Fixed internal	Fixed internal	Fixed internal	Hot swap internal	
	-48VDC PSU option				■	
	Redundant PSU support	■	■		■	
SCALABILITY	Redundant PSU chassis (inc 1 PSU)	AT-RPS3204	AT-RPS3204			
	Additional redundant PSU	AT-PWR3202	AT-PWR3202		AT-PWR01	
	MAC address table size	16K	16K	16K	16K	
ENVIRONMENTAL	Stacking	■ AT-STACKXG (4)	■ AT-STACKXG (4)	■ AT-XEM-STK (2)	■ AT-XEM-STK (2)	
MANAGEMENT	Cooling	Fan	Fan	Fan	Hot swappable fan module	
	Web	■	■	■	■	
NETWORK RESILIENCE	CLI / Telnet / SNMP	■	■	■	■	
	Spanning-Tree	■	■	■	■	
	Link aggregation (LACP)	■	■	■	■	
SECURITY	EPSSR	■	■	■	■	
	QoS	IEEE 802.1p priority queues	8	8	8	8
	IEEE 802.1Q VLANs	4096	4096	4096	4096	
	RADIUS	■	■	■	■	
ROUTING	SSH/SSL	■	■	■	■	
	IEEE 802.1x	■	■	■	■	
	DoS protection	■	■	■	■	
	RIPv1 and v2	■	■	■	■	
	IPv4	■	■	■	■	
	IPv6	■	■	■	■	
	OSPFv2	■	■	■	■	
DIMENSIONS	VRRP	■	■	■	■	
	ECMP	■	■	■	■	
DIMENSIONS	(W x D x H)	44 x 30.5 x 4.4cm 17.3 x 12 x 1.73in	44 x 30.5 x 4.4cm 17.3 x 12 x 1.73in	44 x 35 x 4.4cm 17.3 x 13.8 x 1.73in	44 x 44 x 4.4cm 17.5 x 17.3 x 1.73in	
	Weight	4.6kg / 10.1lbs (unpackaged)	4.9kg / 10.8lbs (unpackaged)	5.3kg / 11.6lbs	7.3kg / 16.09lbs (with 1 PSU)	

The 10 Gigabit Ethernet, 10GbE or 10 GigE standard was first published in 2002 as IEEE Standard 802.3ae-2002 and is the fastest of the Ethernet standards. It defines a version of Ethernet with a nominal data rate of 10Gbit/s, ten times as fast as Gigabit Ethernet. This is making 10 Gigabit Ethernet the main technology used for backbone networks at the current period in time.

Affordable Solutions

10 Gigabit solutions are extremely affordable for customers requiring this level of performance. Using fiber optic cables to provide connectivity, XFP modules are significantly less expensive than 10 x SFP modules for the same distance of connectivity. (For information on SFP and XFP modules, see pages 24/25.)



10 Gigabit Switches



	AT-x900-24XS	AT-SBx908
	» Desktop » Rackmountable » Stackable	» Rackmountable » Stackable
	Advanced Layer 3	Advanced Layer 3
	24	
	2	8
	AT-XEM-12T	AT-XEM-12T
	AT-XEM-12S	AT-XEM-12S
	AT-XEM-1XP	AT-XEM-1XP
	AT-XEM-2XP	AT-XEM-2XP
	Hot swap internal	Hot swap internal
	■	■
	■	■
	AT-PWR01	AT-PWR05
	16K	16K
	■ AT-XEM-STK (2)	■ Rear stacking (2)
	Hot swappable fan module	Hot swappable fan module
	■	■
	■	■
	■	■
	■	■
	8	8
	4096	4096
	■	■
	■	■
	■	■
	■	■
	■	■
	■	■
	■	■
	■	■
	■	■
	44 x 44 x 4.4cm 17.5 x 17.3 x 1.73in	44 x 45.6 x 13.2cm 17.3 x 18 x 5.2in
	7.3kg / 16.09lbs (with 1 PSU)	14.32kg / 31.57lbs (no PSUs)

Allied Telesis XEM Modules

All of these modules provide non-blocking performance and are compatible with the x900 series and the SwitchBlade x908.



AT-XEM-STK



AT-XEM-2XP



AT-XEM-1XP



AT-XEM-12S



AT-XEM-12T

Implementing the Standard

The IEEE standard allows multiple implementations for use over the different types of fiber optic cable. In the 10GBASE-X media types, an 'S' stands for the 850 nanometer (nm) wavelength of fiber optic operation, an 'L' stands for 1310 nm, and an 'E' stands for 1550 nm. The letter 'X' denotes 8B/10B signal encoding, while 'R' denotes 66B encoding. Therefore, Allied Telesis' XFP are as follows:

SFP	Standard	Wavelength	Cable Type
AT-XPSR	10GBase-SR	850nm	Multi-mode fiber (MMF)
AT-XPLR	10GBase-LR	1310nm	Single-mode fiber (SMF)
AT-XPER40	10GBase-ER	1550nm	Single-mode fiber (SMF)
AT-XPER80	10GBase-ER	1550nm	Single-mode fiber (SMF)



Notes



SwitchBlade® x908

SwitchBlade

SwitchBlade x908 is the latest core switching product from Allied Telesis

The Allied Telesis SwitchBlade x908 (AT-SBx908) advanced Layer 3 modular switch delivers exceptional performance and functionality through eight high-speed expansion bays. Key features of the switch make it the ideal solution for both enterprise and service provider customers.

Advanced Layer 3 Modular Switch

The Allied Telesis AT-SBx908 industry leading modular switch incorporates eight high-speed 60Gbps expansion bays, delivering a new generation of high performance. The AT-SBx908 provides scalable and versatile switching solutions for today's enterprise networks. The highly configurable AT-SBx908 3RU modular switch combines an advanced IPv4 Layer 3 feature set and comprehensive IPv6 routing features, with wirespeed IPv6 hardware capability, future proofing the network. Featuring dual hot swap PSUs, an advanced QoS feature set, multi-casting support, and LAN resiliency support, the AT-SBx908 also provides service provider capabilities such as a large Layer 3 route table, and EPSR support. Stacking between two units is supported via fixed stacking connectors on the rear of the chassis, providing 160Gbps of stacking bandwidth. The AT-SBx908 incorporates the AlliedWare Plus™ operating system, using an industry standard Command Line Interface (CLI), facilitating effortless manageability.

Performance

With a massive 640Gbps of switching fabric, the AT-SBx908 has more than enough performance to provide wirespeed routing and throughput to any port. With the switching fabric capable of a forwarding rate of 476Mpps, (maximum throughput is 357Mpps with current expansion modules), the design is future proofed for planned enhanced modules.

Expandability

Each AT-SBx908 modular switch features high-speed stacking interface, allowing two switches to be inter-connected in a Virtual Chassis Stack (VCStack) through a 160Gbps bandwidth link. Operating in this mode, both switches are fully operational, whilst providing resiliency at the core of the network.

Flexibility

The XEM (Expansion Modules) allow connectivity at speeds from Ethernet to 10 Gigabit Ethernet. The same XEM modules are compatible with the x900 series of switches (see pages 18-21), enabling users to re-deploy modules when reconfiguring their networks, and reducing spares requirements. By using small port count modules, users can build highly granular and flexible networks, whilst also reducing overall system costs in applications requiring only a small number of fiber or copper links.

Each SwitchBlade x908 switch can support the following number of interfaces:

Interface Type	Max Speed	XEM Module	# Ports
SFP	Gigabit	AT-XEM-12S	96
RJ-45	Gigabit	AT-XEM-12T	96
XFP	10 Gigabit	AT-XEM-2XP	16

Resilience

Network resilience is provided in both hardware and network architecture. Dual hot swappable power supplies ensure uninterrupted operation of a switch, whilst the Virtual Chassis Stack (VCStack) provides a resilient network architecture should a single switch fail. In addition to standard resiliency Spanning-Tree based protocols, the AT-SBx908 support EPSR (Ethernet Protected Switched Rings), which allows networks to re-configure and re-establish connections in as little as 50ms. This allows the switch to be used in voice and video applications, which require minimal interruptions to the data streams.

IPv4 and IPv6

The switch combines an advanced IPv4 Layer 3 feature set and also comprehensive IPv6 routing features, with wirespeed IPv6 hardware capability. This allows the switch to be deployed in current networks, allowing it to easily migrate to future networks when IPv6 is deployed.

AlliedWare Plus Operating System

The AT-SBx908 uses the latest AlliedWare Plus operating system. Utilizing an industry standard Command Line Interface (CLI), it features an intuitive management interface, requiring minimal product specific training, easily allowing certified network engineers to configure the switch.





Switch Features

Network Access Control (NAC)

NAC allows you unprecedented control over user access to your network, in order to mitigate threats to network infrastructure. NAC provides this security optimally at the interface between the user and the network, assigning network access based on identity, access method, location and end-point security status.

Allied Telesis switches support NAC by using IEEE 802.1x port-based authentication in partnership with standards-compliant dynamic VLAN assignment. Once a user is authenticated, a VLAN ID is dynamically assigned to the user, based on that user's identity, and on the end-points adherence to the security policies of the network. The user is then either granted appropriate access to network resources, or is offered remediation via a remediation VLAN to improve the end-points security posture.

Our switches also support alternatives to IEEE 802.1x port-based authentication. For example, we support Web authentication to enable guest access, and MAC authentication to enable end-points that do not have an IEEE 802.1x supplicant. Furthermore, features such as multi-authentication allow authentication in cases where multiple users share a port. A Guest VLAN (also known as Default VLAN) can be configured to provide a catch-all for users without an IEEE 802.1x supplicant. As well as supporting a RADIUS client for remote authentication, our switches also support a local RADIUS server for local authentication.

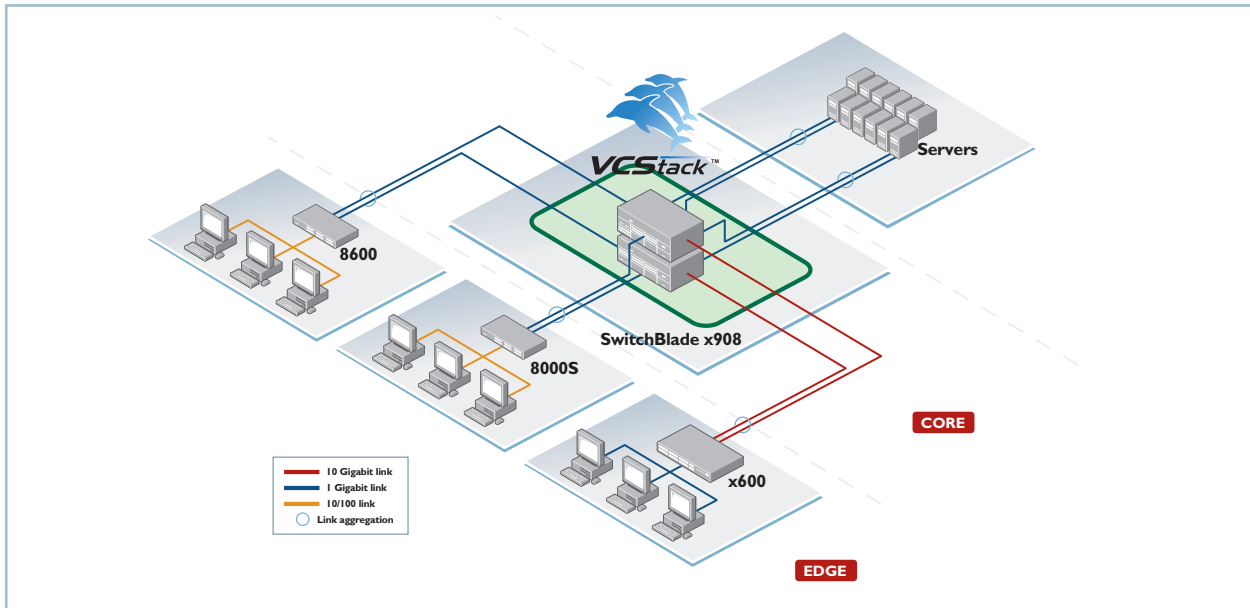

Resilient Core Solution

With two 160Gbps stacking ports on the rear of the device, the SwitchBlade x908 is an ideal solution for enterprises wanting to create a resilient core without going to the expense of a full chassis solution. The use of stacking across the two devices allows them to appear as a single node on the network.

Link aggregation between the stacked core and distribution or edge switches, as illustrated in the diagram, provides increased bandwidth as well as resiliency, with dual links to the virtual chassis stack connecting to different chassis members. Link aggregation to the servers creates a resilient connection to important data.



Notes



Optical Network Components



GIGABIT FIBER OPTICS						
SUBCATEGORY	AT-SPSX	AT-SPSX/I	AT-G8SX	AT-SPEX	AT-SPLX10	
FORM FACTOR	SFP	SFP	GBIC	SFP	SFP	
FIBER TYPE	MMF	MMF	MMF	MMF	SMF	
NUMBER OF FIBERS	2 (Rx,Tx)	2 (Rx,Tx)	2 (Rx,Tx)	2 (Rx,Tx)	2 (Rx,Tx)	
SPEED	1000Mbps	1000Mbps	1000Mbps	1000Mbps	1000Mbps	
Rx WAVELENGTH	850nm	850nm	850nm		1310nm	
Tx WAVELENGTH	850nm	850nm	850nm		1310nm	
MAX FIBER DISTANCE	220 / 550m	220 / 550m	220 / 550m	2km	10km	
CONNECTOR TYPE	LC	LC	SC	LC	LC	
TEMPERATURE	Commercial	Industrial	Commercial	Commercial	Commercial	



FAST ETHERNET FIBER OPTICS				
SUBCATEGORY	AT-SPFX/2	AT-SPFXBD-LC-13	AT-SPFXBD-LC-15	AT-SPFX/15
FORM FACTOR	SFP	SFP	SFP	SFP
FIBER TYPE	MMF	SMF	SMF	SMF
NUMBER OF FIBERS	2 (Rx,Tx)	1 (BiDi)	1 (BiDi)	2 (Rx,Tx)
SPEED	100Mbps	100Mbps	100Mbps	100Mbps
Rx WAVELENGTH	1310nm	1510nm	1310nm	1310nm
Tx WAVELENGTH	1310nm	1310nm	1510nm	1310nm
MAX FIBER DISTANCE	2km	10km	10km	15km
CONNECTOR TYPE	LC	LC - BiDi	LC - BiDi	LC



COPPER		
SUBCATEGORY	AT-SPTX	AT-G8T
FORM FACTOR	SFP	GBIC
SPEED	10/100/1000T	10/100/1000T
MAX COPPER DISTANCE	100m	100m
CONNECTOR TYPE	RJ-45	RJ-45

Optical Connectors

The networking industry is constantly changing the types of optical network connectors, to keep pace with the increasing demands of higher data throughput and smaller physical footprints.

LC Connector

This is a small physical connector, which is being used extensively in Gigabit and 10 Gigabit networks. This connector is found on SFP and XFP optical modules.



SC Connector

This connector is still popular for Gigabit, Fast Ethernet and Ethernet. It is however being superseded by the LC connector in Gigabit applications, as the LC connector is physically smaller, thus allowing a higher density of connectors. This connector is found on GBIC optical modules.





GIGABIT FIBER OPTICS

	AT-SPLX10/I	AT-G8LX10	AT-SPBD10-13	AT-SPBD10-14	AT-SPLX40	AT-SPZX80
FORM FACTOR	SFP	GBIC	SFP	SFP	SFP	SFP
FIBER TYPE	SMF	SMF	SMF	SMF	SMF	SMF
NUMBER OF FIBERS	2 (Rx, Tx)	2 (Rx, Tx)	1 (BiDi)	1 (BiDi)	2 (Rx, Tx)	2 (Rx, Tx)
SPEED	1000Mbps	1000Mbps	1000Mbps	1000Mbps	1000Mbps	1000Mbps
Rx WAVELENGTH	1310nm	1310nm	1490nm	1310nm	1310nm	1550nm
Tx WAVELENGTH	1310nm	1310nm	1310nm	1490nm	1310nm	1550nm
MAX FIBER DISTANCE	10km	10km	10km	10km	40km	80km
CONNECTOR TYPE	LC	SC	LC - BiDi	LC - BiDi	LC	LC
TEMPERATURE	Industrial	Commercial	Commercial	Commercial	Commercial	Commercial



10 GIGABIT FIBER OPTICS (XFP)

SUBCATEGORY	AT-XPSR	AT-XPLR	AT-XPER40	AT-XPER80
FORM FACTOR	XFP	XFP	XFP	XFP
FIBER TYPE	MMF	SMF	SMF	SMF
NUMBER OF FIBERS	2 (Rx, Tx)	2 (Rx, Tx)	2 (Rx, Tx)	2 (Rx, Tx)
SPEED	10G	10G	10G	10G
Rx WAVELENGTH	850nm	1310nm	1550nm	1550nm
Tx WAVELENGTH	850nm	1310nm	1550nm	1550nm
MAX FIBER DISTANCE	300m	10km	40km	80km
CONNECTOR TYPE	LC	LC	LC	LC
TEMPERATURE	0°C to 70°C	0°C to 70°C	-5°C to 70°C	-5°C to 70°C



10 GIGABIT FIBER OPTICS (SFP+)

SUBCATEGORY	AT-SP10SR	AT-SP10LR	AT-SP10LR/I	AT-SP10LR20/I	AT-SP10ER40/I	AT-SP10TW
FORM FACTOR	SFP+	SFP+	SFP+	SFP+	SFP+	SFP+
FIBER TYPE	MMF	SMF	SMF	SMF	SMF	
COPPER TYPE						Twinax
NUMBER OF FIBERS	2	2	2	2	2	
SPEED	10G	10G	10G	10G	10G	10G
Rx WAVELENGTH	850nm	1310nm	1310nm	1310nm	1310nm	
Tx WAVELENGTH	850nm	1310nm	1310nm	1310nm	1310nm	
MAX FIBER DISTANCE	300m	10km	10km	20km	40km	1m
CONNECTOR TYPE	LC	LC	LC	LC	LC	
TEMPERATURE	Commercial	Commercial	Industrial	Industrial	Industrial	Commercial

Fiber Distances

The IEEE 802.3 Ethernet specification for networks over multi-mode fiber are as follows:

Standard	Speed	Max Distance (MMF)
10FL	10Mbps	2km
10FX	100Mbps	2km
100SX	1000Mbps	220m

Customers moving to Gigabit (1000Mbps) may find that existing multi-mode fiber may not be suitable for their network, as the distance required is over 220m. Allied Telesis suggest using the **AT-SPEX** optical transceiver, which uses non-standard optics, but supports the 2km distance.



Notes



Optical Network Media Conversion



ETHERNET AND FAST ETHERNET STANDALONE MEDIA CONVERTERS

SUBCAT	FEATURE	AT-MC13	AT-MC101XL	AT-MC102XL	AT-MC103XL	AT-MC103LH	AT-MC104XL	AT-MC115XL
PORTS	Port 1	10T	100TX	100TX	100TX	100TX	100FX MMF (SC)	10T or 100TX
	Port 2	10FL (ST)	100FX (ST)	100FX (SC)	100FX (SC)	100FX (SC)	100FX (SC)	10FL (ST) or 100FX (ST)
	Fiber type	MMF	MMF	MMF	SMF	SMF	SMF	MMF
IEEE STANDARD		10FL	100FX	100FX	100FX	100FX	100FX	100SX
Tx WAVELENGTH		850nm	1310nm	1310nm	1310nm	1310nm	1310nm	850nm
Rx WAVELENGTH		850nm	1310nm	1310nm	1310nm	1310nm	1310nm	850nm
MAX FIBER DISTANCE		2km	2km	2km	15km	40km	15km	2km
FUNCTIONALITY	Rate and speed							
	MissingLink support		■	■	■	■	■	
	Smart MissingLink support							
	Max frame size	9KB	9KB	9KB	9KB	9KB	9KB	9KB
	Diagnostic LEDs	6	7	7	7	7	7	8
POWER OVER ETHERNET	IEEE 802.3af							
	PoE enabled ports							
	Max no. of full power ports							
	Mode							
POWER SUPPLY	PoE power							
	PSU type (Energy Star)	External	External	External	External	External	External	External
	Multi-region	■				■	■	■
	Compatible with AT-MCR12 12-slot chassis	■	■	■	■	■	■	■
DIMENSIONS	Compatible with AT-MCR1 1-slot chassis	■	■	■	■	■	■	■
	(W x D x H)	10 x 9.5 x 2.5cm 3.93 x 3.74 x 1in	10 x 9.5 x 2.5cm 3.93 x 3.74 x 1in	10 x 9.5 x 2.5cm 3.93 x 3.74 x 1in	10 x 9.5 x 2.5cm 3.93 x 3.74 x 1in	10 x 9.5 x 2.5cm 3.93 x 3.74 x 1in	10 x 9.5 x 2.5cm 3.93 x 3.74 x 1in	10 x 9.5 x 2.5cm 3.93 x 3.74 x 1in
	Weight	.3kg / .66lbs	.3kg / .66lbs	.3kg / .66lbs	.3kg / .66lbs	.3kg / .66lbs	.3kg / .66lbs	.3kg / .66lbs



GIGABIT STANDALONE MEDIA CONVERTERS

SUBCAT	FEATURE	AT-MC1004	AT-MC1008/GB	AT-MC1008/SP	AT-GS2002/SP	AT-PC2002POE
PORTS	Port 1	1000T	1000T	1000T	10/100/1000T	10/100/1000T
	Port 2	1000SX	GBIC	SFP	SFP	SFP 100 or 1000Mbps
	Fiber type	SC	SC *	LC *	LC *	LC *
IEEE STANDARD		1000SX	1000SX and LX	1000SX and LX	1000SX and LX	100FX and 1000X
Tx WAVELENGTH		850nm	Depends on GBIC	Depends on SFP	Depends on SFP	Depends on SFP
Rx WAVELENGTH		850nm	Depends on GBIC	Depends on SFP	Depends on SFP	Depends on SFP
MAX FIBER DISTANCE		550m	Depends on GBIC	Depends on SFP	Depends on SFP	Depends on SFP
FUNCTIONALITY	Rate and speed		■	■	■	■
	MissingLink support	■	■	■	■	■
	Smart MissingLink support	■	■	■	■	■
	Max frame size	9KB	9KB	9KB	1536bytes	1536bytes
	Diagnostic LEDs	8	8	8	11	15
POWER OVER ETHERNET	IEEE 802.3af					■
	PoE enabled ports					1
	Max no. of full power ports					1
	PoE power					15.4W
POWER SUPPLY	PSU type (Energy Star)	External	External	External	External	Internal †
	Multi-region		■	■	■	
	Compatible with AT-MCR12 12-slot chassis	■	■	■	■	
	Compatible with AT-MCR1 1-slot chassis	■	■	■	■	
DIMENSIONS	(W x D x H)	10 x 9.5 x 2.5cm 3.93 x 3.74 x 1in	10 x 9.5 x 2.5cm 3.93 x 3.74 x 1in	10 x 9.5 x 2.5cm 3.93 x 3.74 x 1in	10 x 9.5 x 2.5cm 3.93 x 3.74 x 1in	15.5 x 13.1 x 4cm 6.1 x 5.16 x 1.58in
	Weight	.3kg / .66lbs	.3kg / .66lbs	.3kg / .66lbs	.3kg / .66lbs	.75kg / 1.65lbs

Allied Telesis media converters enable the connection of disparate cabling types in networks where many cabling types exist. Network segments may also operate at different speeds and media converters can be used to convert between one speed and another. Typically, media converters are used to connect copper and fiber-optic cabling that coexist in a network. Converters exist in a variety of standalone, multi-port and modular forms. These different physical forms address the need for different applications and conversion densities.

Allied Telesis is the world's largest media converter manufacturer. Our vast range of products provides connectivity solutions for almost all the needs of carrier, enterprise, and small to medium business customers.

Multi-region Power Adapter

The multi-region power adapters are supplied with four modular 'heads', allowing these adapters to be used in the USA, UK, Europe and Australia.



ETHERNET AND FAST ETHERNET STANDALONE MEDIA CONVERTERS

AT-MC116XL	AT-FS201	AT-FS202	AT-PC232/POE	AT-FS232	AT-FS232/I	AT-FS232/2	AT-FS238A/I	AT-FS238B/I
10T or 100TX	10/100TX	10/100TX	10/100TX	10/100TX	10/100TX	10/100TX	10/100TX	10/100TX
10FL (SC) or 100FX (SC)	100FX (ST)	100FX (SC)	100FX (SC)	100FX (SC)	100FX (SC)	100FX (SC)	100FX (SC)	100FX (SC)
MMF	MMF	MMF	MMF	MMF	SMF	SMF	BiDI - SMF	BiDI - SMF
100SX	100FX	100FX	100FX	100FX	100FX	100FX	100FX	100FX
850nm	1310nm	1310nm	1310nm	1310nm	1310nm	1310nm	1310nm	1550nm
850nm	1310nm	1310nm	1310nm	1310nm	1310nm	1310nm	1550nm	1310nm
2km	2km	2km	2km	2km	15km	40km	15km	15km
	■	■	■	■	■	■	■	■
	■	■	■	■	■	■	■	■
				■				
9KB	1532bytes	1532bytes	1916bytes	1532bytes	1532bytes	1532bytes	1532bytes	1532bytes
8	7	7	13	9	9	9	9	9
			I					
			I					
			A					
			15.4W					
External	External	External	Internal †	External	External	External	External	External
■	■	■		■	■	■	■	■
■	■	■		■	■	■	■	■
■	■	■		■	■	■	■	■
10 x 9.5 x 2.5cm 3.93 x 3.74 x 1in	10 x 9.5 x 2.5cm 3.93 x 3.74 x 1in	10 x 9.5 x 2.5cm 3.93 x 3.74 x 1in	15.5 x 13.1 x 4cm 6.1 x 5.16 x 1.58in	10 x 9.5 x 2.5cm 3.93 x 3.74 x 1in	10 x 9.5 x 2.5cm 3.93 x 3.74 x 1in	10 x 9.5 x 2.5cm 3.93 x 3.74 x 1in	10 x 9.5 x 2.5cm 3.93 x 3.74 x 1in	10 x 9.5 x 2.5cm 3.93 x 3.74 x 1in
.3kg / .66lbs	.3kg / .66lbs	.3kg / .66lbs	.75kg / 1.65lbs	.3kg / .66lbs	.3kg / .66lbs	.3kg / .66lbs	.3kg / .66lbs	.3kg / .66lbs

MissingLink™

Allied Telesis' MissingLink feature enables a media converter to pass the link status of their connections and thereby trigger corrective action when a problem on a link is detected. For example, if the twisted pair cable to the 10/100TX port on an Allied Telesis media converter were to fail, the unit would respond by dropping the link on the 100FX fiber optic port. Most managed devices, such as switches and routers, can be configured to take a specific recovery action in the event of the loss of connection on a port. In some cases, the unit can be configured to seek a redundant path to a disconnected end-node or send out a trap to a network management station, and so alert the network administrator of the problem.

Smart MissingLink™

Allied Telesis' Smart MissingLink feature has identical operation to MissingLink, with the added functionality that the media converter will also flash the Link LED of the port with the link failure. This aids with diagnostics, allowing network administrators to more quickly locate, and rectify the fault.

Redundancy

In many cases, Allied Telesis media converters are critical components in a network carrying data between sites over long distances. It is imperative that all efforts are taken to ensure reliability of the network, and thus a network design with redundancy is mandatory. The components most likely to fail are the power supplies. The majority of Allied Telesis media converters can be deployed with hot swappable, hot removable power supplies to ensure maximum uptime.

* Dependent on SFP
† Energy Star is only appropriate for external power adapters

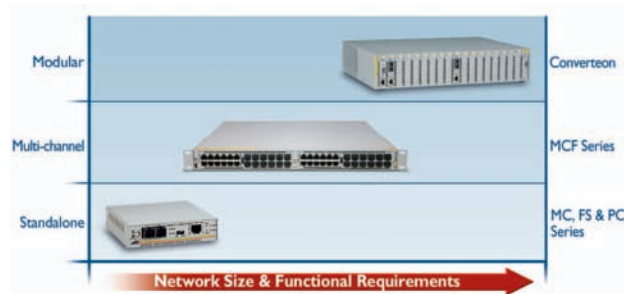

ENERGY STAR

Powered by an ENERGY STAR® qualified adapter for a better environment

Notes



Optical Network Media Conversion

Mounting Options

The majority of unmanaged AT-MC, AT-GS and AT-FS series media converters can be mounted in a number of ways to suit the installation.

Desktop

All Allied Telesis media converters have the option to be fitted with rubber feet. These allow the product to be desktop mounted.

Wall

A standalone media converter or switch can be easily mounted on a wall, or under a table using the AT-WLMT.



■ AT-WLMT Wall-mount fixture (supplied in packs of 10)

DIN Rail

The AT-DINRAIL I is a universal bracket that allows a wide range of Allied Telesis media converters and media/rate converters to be mounted onto an industry standard 35mm DIN Rail.



■ AT-DINRAIL Mounting kit (supplied in packs of 10)

Rack

All the larger multi-channel and modular media converters ship with 19" rack-mount kits. Smaller media converters may also be rack-mounted in a number of ways:



AT-MCRI Chassis

This small chassis can be rack-mounted, and allows a single standalone media converter, or two port switch, to be powered by an internal power supply. It is available with either AC or -48VDC power supply.



AT-MCRI 2 Chassis

This chassis allows up to 12 standalone media converters or switches to be mounted in a chassis. The chassis supports optional redundant power supplies and can be AC or DC powered.



AT-Tray 1 and AT-Tray 4

These simple trays allow either one or up to four standalone media converters to be mounted into a rack.

Universal Energy Star PSU

For customers already using Allied Telesis media converters, replacement Energy Star compliant power adapters are available.

■ AT-MCPWR Universal external Energy Star power adapter



Powered by an ENERGY STAR® qualified adapter for a better environment





		AT-MCF2xxx CHASSIS		
SUBCATEGORY	FEATURE	AT-MCF2012LC	AT-MCF2012LC/I	AT-MCF2032SP
PORTS	Port 1	12 x 10/100TX	12 x 10/100TX	12 x 10/100/1000T
	Port 2	12 x 100FX (LC)	12 x 100FX (LC)	12 x SFP
	Fiber type	MMF	SMF	Depends on SFP
IEEE STANDARD		100FX	100FX	100 or 1000X
Tx WAVELENGTH		1310nm	1310nm	Depends on SFP
Rx WAVELENGTH		1310nm	1310nm	Depends on SFP
MAX FIBER DISTANCE		2km	15km	Depends on SFP
FUNCTIONALITY	Media type	■	■	■
	Rate and speed	■	■	■
	MissingLink support	■	■	■
	Smart MissingLink support	■	■	■
	Max frame size	1632bytes	1632bytes	10KB
	Diagnostic LEDs	■	■	■
DIMENSIONS	(W x D x H) MCF2000	46 x 44 x 4.4cm 18 x 17.3 x 1.73in	46 x 44 x 4.4cm 18 x 17.3 x 1.73in	46 x 44 x 4.4cm 18 x 17.3 x 1.73in
	Weight	8.5kg / 18.74lbs	8.5kg / 18.74lbs	8.5kg / 18.74lbs



AT-MCF2000 Multi-channel Manageable Media Converter

The AT-MCF2000 provides ultra high-density, modular, multi-channel media conversion, with high availability and is ideal for fiber deployments. The units can be used unmanaged, or SNMP managed with the installation of the optional management module.

Features

- Small, 1RU chassis
- High-density conversion, with up to 24 Fast Ethernet channels
- Hot swappable media blades (max of two)
- Hot swappable management module (AT-MCF2000M)
- Stack multiple chassis using stacking modules (AT-MCF2000S)
- Hot swappable power supply modules (AT-MCF2000AC)
- Resilient power supply modules
- Operates in unmanaged and managed modes



AT-MCF2300 4-slot Chassis

The AT-MCF2300 is an end-to-end managed media conversion system. The 3RU chassis can hold either one to four multi-channel blades, providing a maximum of 48 independent channels. An optional management module provides control of the chassis, while dual hot swappable power modules ensure maximum system uptime.

Stacking AT-MCF2xxx Chassis

The AT-MCF2000 can be stacked together to provide a single management entity for the complete stack of up to eight chassis or a maximum of 16 media blades. One chassis has a SNMP management module installed (AT-MCF2000M), and this inter-connects with the other chassis' that are all fitted with a stacking module (AT-MCF2000S).

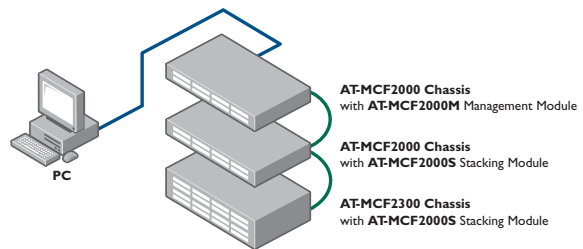

Notes



Optical Network Media Conversion



		CONVERTEON				
SUBCATEGORY	FEATURE	AT-CM301	AT-CM302	AT-CM3K0S	AT-CM70S	AT-CV1KSS
PORTS	Port 1	10/100TX	10/100TX	10/100/1000T	4 x T1/E1 1 x 10/100TX	SFP
	Port 2	100FX (ST)	100FX (SC)	SFP	100Mbps SFP	SFP
	Fiber type	SMF	MMF	Depends on SFP	Depends on SFP	Depends on SFP
IEEE STANDARD		100FX	100FX	1000X		1000X
Tx WAVELENGTH		1310nm	1310nm			1310nm
Rx WAVELENGTH		1310nm	1310nm			1310nm
MAX FIBER DISTANCE		2km	2km	Depends on SFP	Depends on SFP	Depends on SFP
FUNCTIONALITY	Media type	■	■	■	■	■
	Rate and speed	■	■	■	■	■
	MissingLink support	■	■	■		■
	Smart MissingLink support	■	■	■		■
	Max frame size	1535bytes	1535bytes	1632bytes	1535bytes	9KB
	Diagnostic LEDs	9	9	9	23	7
	Rate limiting	■	■	■		■
OAM	Dying gasp support	■	■	■	■	
	Management	■	■	■	■	
ECO FRIENDLY		■	■	■		
DIMENSIONS	(W x D x H)	2.2 x 7.3 x 13cm .85 x 2.89 x 5.1in	2.2 x 7.3 x 13cm .85 x 2.89 x 5.1in	2.2 x 7.3 x 13cm .85 x 2.89 x 5.1in	4.4 x 7.3 x 13cm 1.71 x 2.89 x 5.1in	2.2 x 7.3 x 13cm .85 x 2.89 x 5.1in
	Weight	.27kg / .06lbs	.27kg / .06lbs	.27kg / .06lbs	.54kg / 1.2lbs	.27kg / .06lbs

Converteon™ Managed Media Conversion System

The Converteon family provides the next generation of managed media conversion. Expandable from a single unit to a modular 18-slot chassis, Converteon primarily provides Fast Ethernet and Gigabit rate media conversion. Current support for IEEE 802.3ah EFM (Ethernet in the First Mile) makes Converteon ideal for both service providers and enterprise.



AT-CV500I

18-slot rack-mount chassis

Features

- Redundant AC chassis
- Optional Telnet and SNMP management (AT-CV5M02)
- Optional redundant management with the addition of a second management module (AT-CV5M02)
- Hot swappable blades
- Field serviceable power supplies and fans
- Hot swappable power supply modules (AT-CV500IAC-60 and AT-CV500IDC-80)
- Resilient power supply modules (maximum of two)

AT-CV1000

1-slot

Feature

- External Energy Star power adapter



AT-CV1203

2-slots

Features

- External Energy Star power adapters (1 as standard)
- Resilient power adapters (AT-CV1200PSU)
- Supports dying gasp





OAM

The Operation, Administration and Maintenance (OAM) is a group of functions that provides tools and utilities used to manage a network. The OAM feature part of the IEEE 802.3a standard, and is used to provide network indication, system configuration, performance monitoring, security management, diagnostic functions and configuration. Each function in the OAM feature is described below:

Operations: Coordinates actions between Administration and Maintenance functions.

Administration: Coordinates administrative functions such as designing a system or network, processing order, assigning addresses, tracking usage and accounting.

Maintenance: Coordinates maintenance functions such as diagnosing and troubleshooting system features that do not work as planned.

Without OAM, each individual end-point on a network would need to be managed separately, requiring higher cost end-point hardware, more complex and expensive end-point equipment, and a huge increase in the amount of network traffic (SNMP) needed to monitor the network.

With OAM, low-cost end-points communicate with a central SNMP managed media converter; thus simplifying the network topology, and significantly reducing network cost.

Dying Gasp (IEEE 802.3ah)

Dying gasp is a short message sent by the remotely located media converter to a central media converter; when a power outage occurs. The message indicates to the central converter that the link was lost due to power; and not to either a fault in the remote equipment or the fiber link. Dying gasp is supported on the AT-CV1203 2-slot chassis. This chassis provides network resilience through two external power adapters. The central chassis is notified when the first supply fails, and again via dying gasp when the second supply fails.

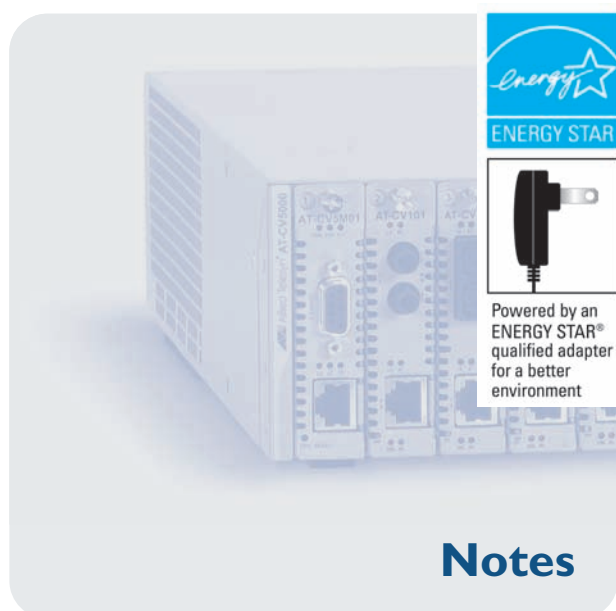



NICs - Desktops / Workstations



SUBCATEGORY	FEATURE	COPPER		COPPER AND FIBER	
		AT-2912T	AT-2451FTX	AT-2701FTX	AT-2716FX/TP
BUS TYPE		PCIe (x1)	PCI (32-bit)	PCI (32-bit)	PCIe (x1)
PORTS AND MEDIA SUPPORT	I0/100TX		■	■	
	I0/100TX PoE Class 3				■
	I0/100/1000T	■			
	I0FL		SC, ST		
	I00FX			MT, SC, ST	SC
FIBER TYPE			MMF	MMF	MMF
MAX FIBER DISTANCE			2km	2km	2km
QoS	IEEE 802.1p priority queues	■	■	■	■
PERFORMANCE	TCP/IP checksum CPU offload	■			■
	Jumbo frames	■			■
	Link aggregation support		■	■	
	Link aggregation failover		■	■	
MANAGEMENT	Wake-on-LAN	■		■	■
	Managed boot agent (PXE remote boot ROM)	2.1	2.1	2.1	2.1
	DASH (TruManage)	■			
	VLAN support	■	■	■	■
	Advanced power management (ACPI)	■	■	■	■
	SNMP	■			■
SECURITY	DES encryption	■			
	3DES encryption	■			
	AES encryption	■			
DRIVER SUPPORT	Windows 7 (32 and 64-bit)	■	■	■	■
	Windows 2008	■	■	■	
	Vista (32 and 64-bit)	■	■	■	■
	Windows XP	■	■	■	■
	Windows XP 64-bit	■	■	■	
	Windows 2003	■	■	■	
	Windows 2003 64-bit	■	■	■	
	Windows 2000	■	■	■	
	NDIS2	■	■	■	■
	NetWare 6.x	■	■	■	
Linux 2.4	■	■	■		
Linux 2.6	■	■	■		
IPv6 SUPPORT		■	■	■	■
DIAGNOSTICS	LEDs	■	■	■	■
	Virtual cable tester	■			
PHYSICAL	Low profile bracket and full height provided	■	■	■	■
DIMENSIONS	(W x H)	10.7 x 5.7cm 4.2 x 2.2in	16.8 x 6.5cm 6.6 x 2.5in	16.8 x 6.5cm 6.6 x 2.5in	15.5 x 6.1cm 6.6 x 2.2in
	Weight	.04kg / .05lbs	.07kg / .15lbs	.07kg / .15lbs	.068kg / .15lbs
IDEAL ENVIRONMENT		» Desktop computers in ultra secure areas	» Desktop computers in secure areas	» Desktop computers in secure areas	» Desktop computers with fiber interfaces that want to power a PoE phone (or other device) from the secondary port
CUSTOMER'S NEEDS		» Data encryption	» 10Mbps fiber connectivity » Choice of fiber or copper interfaces	» 100Mbps fiber connectivity » Choice of fiber or copper interfaces	» PoE

Tagged VLAN Support

Simple interface cards either do not support VLANs, or can only be members of a single VLAN. Allied Telesis' fiber NIC offerings have advanced VLAN support which allows the card to be a member of multiple VLANs. This allows a single interface card to be installed in a server, rather than multiple cards, one for each VLAN. Implementing VLANs on a network ensures additional data security as only users of the same VLAN can share information.

Load Balancing and Auto-Failover (LBFO)

Allied Telesis provides LBFO on the majority of its NICs. This feature is primarily intended to be used with multiple interface cards in servers. Bandwidth is increased by sending the traffic over two or more interface cards and the network resiliency is also improved by providing a redundant link from the server to the network should a link fail. The LBFO feature allows the bandwidth from a network server to be effectively doubled, as the two interface cards function as one virtual adapter:

Network giving you a headache? Congestion slowing you down?



Allied Telesis have the perfect cure.

Too much traffic and bandwidth-hungry applications can clog up your network, often blocking access to important information. Like a persistent cold, a congested network slows down your entire system.

Why not let Allied Telesis help you run a congestion free network. Our wide range of products can eliminate network traffic jams by streamlining, prioritizing and optimizing your traffic to meet your application requirements. Whether it be the movement of large image files, accessing customer files, or live streaming of high definition video, Allied Telesis can make all the difference.

www.alliedtelesis.com

Connecting The  World

© 2010 Allied Telesis Inc. All rights reserved.

 Allied Telesis™



NICs - Desktops / Workstations



		FIBER 1000SX					
SUBCATEGORY	FEATURE	AT-2916SX	AT-2916LX10	AT-2931SX	AT-2972SX	AT-2972LX10	
BUSTYPE		PCI (32-bit)		PCI-x (32/64-bit)	PCIe (x1)		
PORTS AND MEDIA SUPPORT	I0FL						
	I00FX						
	I000SX	LC, SC	LC	LC, SC	LC	LC	
FIBER TYPE		MMF	SMF	MMF	MMF	SMF	
MAX FIBER DISTANCE		220m	10km	220m	220m	10km	
QoS	IEEE 802.1p priority queues	■	■	■	■	■	■
PERFORMANCE	TCP/IP checksum CPU offload	■	■	■	■	■	■
	Jumbo frames	■	■	■	■	■	■
	Link aggregation support	■	■	■	■	■	■
	Link aggregation failover	■	■	■	■	■	■
MANAGEMENT	Wake-on-LAN						
	Managed boot agent (PXE remote boot ROM)	2.1	2.1	2.1	2.1	2.1	
	DASH (TruManage)						
	VLAN support	■	■	■	■	■	■
	Advanced power management (ACPI)	■	■	■	■	■	■
SECURITY	SNMP	■	■	■	■	■	■
	DES encryption						
	3DES encryption						
DRIVER SUPPORT	AES encryption						
	Windows 7 (32 and 64-bit)	■	■	■	■	■	■
	Windows 2008 (32 and 64-bit)	■	■	■	■	■	■
	Vista (32 and 64-bit)	■	■	■	■	■	■
	Windows XP (32 and 64-bit)	■	■	■	■	■	■
	Windows 2003 (32 and 64-bit)	■	■	■	■	■	■
	Windows 2000	■	■	■	■	■	■
	NDIS2	■	■	■	■	■	■
	NetWare 6.x	■	■	■	■	■	■
	Linux 2.4	■	■	■	■	■	■
Linux 2.6	■	■	■	■	■	■	
IPv6 SUPPORT		■	■	■	■	■	
DIAGNOSTICS	LEDs	■	■	■	■	■	■
PHYSICAL	Low profile bracket and full height provided	■	■	■	■	■	■
DIMENSIONS	(W x H)	11.9 x 6.4cm 4.68 x 2.5in	11.9 x 6.4cm 4.68 x 2.5in	16.8 x 6.4cm 6.6 x 2.5in	16.8 x 6.8cm 6.6 x 2.67in	16.8 x 6.8cm 6.6 x 2.67in	
	Weight	.06kg / .13lbs	.06kg / .13lbs	.07kg / .15lbs	.06kg / .13lbs	.06kg / .13lbs	
	IDEAL ENVIRONMENT	» Desktop computers in secure areas	» Desktop computers in secure areas	» Service requiring Gigabit connectivity	» Service requiring Gigabit connectivity	» Service requiring Gigabit connectivity	
CUSTOMER'S NEEDS	» Performance	» Performance » Long distance networking	» High performance » Load balancing » Redundant links	» High performance » Load balancing » Redundant links	» High performance » Load balancing » Redundant links	» High performance » Load balancing » Long distance networking	

Managed Boot Agent (MBA) Support

The MBA support on Allied Telesis NICs allows network administrators to perform pre-boot procedures on a system, such as installing an operating system, running a virus checker, or downloading a predefined system configuration. This feature, coupled with the Wake-on-LAN (WoL) function, allows computers to be remotely powered-on during non-work hours to perform configuration and maintenance tasks. Pre-boot Execution Environment (PXE) support is included in Allied Telesis' NICs. It allows a workstation or computer to boot from a remote server connected to the network prior to booting from the local hard drive.

Network Security

Although fiber optic networking provides a much higher level of network security than copper, security can be further enhanced by encrypting the data being transmitted. Allied Telesis security cards perform high levels of encryption/decryption, freeing the host CPU of this performance intensive task.



NICs - Laptops / Servers



		LAPTOPS		
		FIBER 100FX		FIBER 1000SX
SUBCATEGORY	FEATURE	AT-2801FX	AT-2812FX	AT-2872SX
BUS TYPE		CardBus	ExpressCard 34	ExpressCard 34
PORTS AND MEDIA SUPPORT	100FX	SC, ST	SC	
	1000SX			SC
QoS	IEEE 802.1p priority queues	■	■	■
PERFORMANCE	TCP/IP checksum CPU offload		■	■
MANAGEMENT	Wake-on-LAN	■		
	Managed boot agent (PXE remote boot ROM)		2.1	2.1
	DASH (TruManage)		■	
	VLAN support		■	■
	Advanced power management (ACPI)	■	■	■
	SNMP		■	■
SECURITY	DES encryption		■	
	3DES encryption		■	
	AES encryption		■	
DRIVER SUPPORT	Windows 7	■	■	■
	Windows 7 (64-bit)		■	■
	Vista	■	■	■
	Vista 64-bit		■	■
	Windows XP	■	■	■
	NDIS2		■	■
	Linux 2.4		■	■
Linux 2.6		■	■	
IPv6 SUPPORT		■	■	■
DIAGNOSTICS	LEDs	■	■	■
DIMENSIONS	(W x H)	12 x 6.9cm 4.76 x 2.71in	12.9 x 3.4cm 5.1 x 1.2in	12.9 x 3.4cm 5.1 x 1.2in
	Weight	.05kg / .09lbs	.036kg / .08lbs	.036kg / .08lbs
IDEAL ENVIRONMENT		» Laptop computers in secure areas	» Laptop computers in secure areas	» Laptop computers with fiber connectivity
CUSTOMER'S NEEDS		» 100Mbps fiber connectivity » Laptop connectivity	» 100Mbps fiber connectivity » Laptop connectivity	» 100Mbps fiber connectivity » Laptop connectivity

Jumbo Frames Support

Normal Ethernet packets are limited to a maximum size of 1548bytes. Packets which are received that are larger than this are normally rejected by the interface card as errors. The jumbo frame support is beneficial to sending large packets, especially where the data contained in these packets either has a time critical element, or is so large that the time taken to send multiple smaller packets is too great. Jumbo frame packets are normally up to 9000bytes long.

Advanced Power Management (ACPI)

ACPI is part of the environmental control initiative for computers. Allied Telesis NICs support ACPI which places the system in a low power state when it is not receiving or transmitting data.

Wake-on-LAN (WoL) is a feature of interface cards that allows a computer fitted with a card to be remotely powered on. The computer receives a special data packet via the network port that will cause the computer to boot. This coupled with PXE support allows network administrators to gain complete access to all computers on their network.



Network Interface Cards



		SERVERS		
		COPPER		
SUBCATEGORY	FEATURE	AT-2973SX	AT-2973T	AT-2973T/4
BUS TYPE		PCIe (x4)	PCIe (x4)	PCIe (x4)
PORTS AND MEDIA SUPPORT	10/100/1000T		■ (2 ports)	■ (4 ports)
	1000SX	LC (2 ports)		
QoS	IEEE 802.1p priority queues	■	■	■
PERFORMANCE	TCP/IP checksum CPU offload	■	■	■
	Jumbo frames	■	■	■
	Link aggregation support	■	■	■
	Link aggregation failover	■	■	■
	iWARP (RNIC RDMA)	■	■	■
	iSCSI	■	■	■
MANAGEMENT	Wake-on-LAN		■	■
	Managed boot agent (PXE remote boot ROM)	2.1	2.1	2.1
	VLAN support	■	■	■
	Advanced power management (ACPI)	■	■	■
	SNMP	■	■	■
DRIVER SUPPORT	Windows 7 (32 and 64-bit)	■	■	■
	Windows 2008 (32 and 64-bit)	■	■	■
	Vista (32 and 64-bit)	■	■	■
	Windows 2003 (32 and 64-bit)	■	■	■
	Linux 2.4	■	■	■
	Linux 2.6	■	■	■
IPv6 SUPPORT		■	■	■
DIAGNOSTICS	LEDs	■	■	■
	Virtual cable tester		■	■
PHYSICAL	Low profile bracket and full height provided	■	■	■
DIMENSIONS	(W x H)	14.5 x 5.7cm 5.7 x 2.2in	14.5 x 5.7cm 5.7 x 2.2in	15.3 x 11.1cm 6.03 x 4.38in
	Weight	.05kg / .09lbs	.05kg / .09lbs	.10kg / .23lbs
IDEAL ENVIRONMENT		» Virtualization servers	» Virtualization servers	» Virtualization servers
CUSTOMER'S NEEDS		» High performance with low CPU utilization	» High performance with low CPU utilization	» High performance with low CPU utilization

Network Virtualization

The 2973 series of Network Interface Cards have been specifically designed for use in a virtualized environment. The cards interact directly with the virtualization hypervisor software, offloading many of the interface tasks from the main CPU, thus increasing overall performance of a virtual machine.

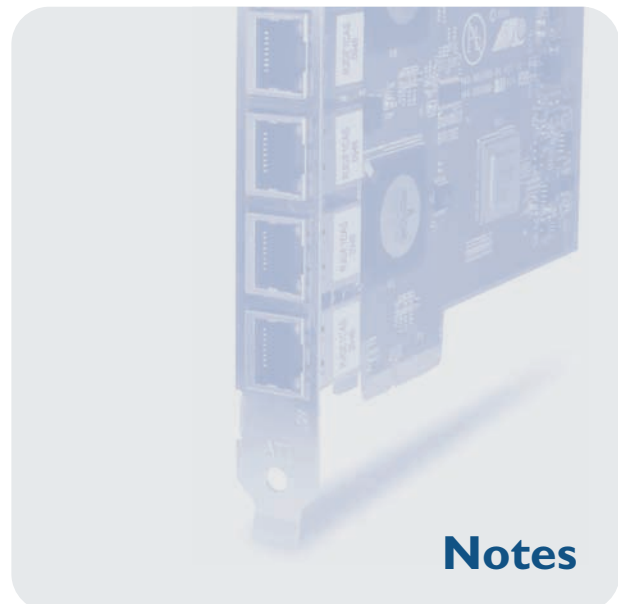

Notes



Routers

Routers



		SECURE MODULAR VPN ROUTERS		SECURE GIGABIT MODULAR VPN ROUTER
SUBCATEGORY	FEATURE	AT-AR415S	AT-AR750S	AT-AR770S
FORM FACTOR		» Desktop » Rackmountable	» Desktop » Rackmountable	» Desktop » Rackmountable
PORTS AND MEDIA SUPPORT	10/100TX	1 (WAN) + 4 (LAN)	2 (WAN) + 5 (LAN)	
	10/100/1000T			2 (WAN) + 4 (LAN)
	SFP			2 (combo) 100 or 1000Mbps
	xDSL (WAN)			
	Async port	1	1	1
PIC BAYS	PIC bays	1 (optional)	2 (optional)	2 (optional)
	E1/T1 WAN	AT-AR020	AT-AR020	AT-AR020
	BRI - ISDN (S/T)	AT-AR021S	AT-AR021S	AT-AR021S
	2Mbps sync port	AT-AR023	AT-AR023	AT-AR023
	4 x async	AT-AR024	AT-AR024	AT-AR024
	2 x FXS VoIP	AT-AR027		
POWER SUPPLY		Fixed internal	Fixed internal	Fixed internal
ENVIRONMENTAL	In/outdoor usage	Indoor	Indoor	Indoor
	Operating temperature range (°C)	0°C to 40°C	0°C to 40°C	0°C to 40°C
MANAGEMENT	Web	■	■	
	CLI access	Async, Telnet	Async, Telnet	Async, Telnet
	SNMP	v2 and v3	v2 and v3	v2 and v3
	UPnP	■		
NETWORK RESILIENCE	VRRP	■	■	■
QoS	IEEE 802.1p priority queues	■	■	■
	Queueing mechanisms	■	■	■
	Priority mechanisms	■	■	■
SECURITY	IEEE 802.1Q VLANs	64	64	64
	RADIUS	■	■	■
	SSL	■	■	■
	IEEE 802.1x	■	■	■
	DoS protection	■	■	■
	Firewall	4000 sessions (AT-FL18B) 8000 sessions (AT-FL18C)	■	■
OTHER	DMZ	■	■	■
	MAC filter	■	■	■
	IP / TCP / UDP filter	■	■	■
	URL filter	■	■	■
	Peer-to-peer protocols detection	■	■	■
	Encryption (DES, 3DES, AES)	■	■	■
	VPN concurrent tunnels	1 - standard 5 - AT-FL19B, 10 - AT-FL19C 25 - AT-FL19D, 50 - AT-FL19E	250	1000
ROUTING	RIPv1 and v2	■	■	■
	IPv4	■	■	■
	IPv6	AT-AR400-ADVL3UPGRD	AT-AR700-ADVL3UPGRD	AT-AR700-ADVL3UPGRD
	OSPF	■	■	■
	NAT / NAPT	■	■	■
	NAT VPN pass-through (sessions)	■	■	■
	PPPoE / PPTP / L2TP	■	■	■
	DHCP client / server / relay	■	■	■
	WAN load balancing	AT-FL15 (option)	Included	Included
	Server load balancing	AT-AR400-ADVL3UPGRD	AT-AR700-ADVL3UPGRD	AT-AR700-ADVL3UPGRD
BGP-4	AT-AR400-ADVL3UPGRD	AT-AR700-ADVL3UPGRD	AT-AR700-ADVL3UPGRD	
DIMENSIONS	(W x D x H)	30.5 x 19 x 4.5cm 12 x 7.48 x 1.77in	30.5 x 19 x 4.4cm 12 x 7.48 x 1.73in	44 x 23.9 x 4.4cm 17.3 x 9.4 x 1.73in
	Weight	1.75kg / 3.85lbs	1.92kg / 4.23lbs	2.95kg / 6.5lbs
IDEAL ENVIRONMENT		» Medium business	» Medium business	» Large business
CUSTOMER'S NEEDS		» Remote access	» Remote access	» Remote access

Virtual Private Networks

Virtual Private Networks are secure data tunnels connected over a Wide Area Network (WAN). They provide the user with an extension of a LAN (Local Area Network) in a remote location. By providing strong levels of authentication and data encryption, users are secure in the knowledge that their

confidential information can be carried over the Internet. For central site applications, routers need to support multiple concurrent VPN tunnels, to cater for large numbers of remote tele-workers or remote offices.



SECURE xDSL ROUTERS

	AT-AR440S	AT-AR441S	AT-AR442S
	» Wallmountable » Desktop » Rackmountable	» Wallmountable » Desktop » Rackmountable	» Wallmountable » Desktop » Rackmountable
	5 (LAN)	5 (LAN)	5 (LAN)
	ADSL2/2+ (Annex A)	ADSL2/2+ (Annex B)	SHDSL
	■	■	■
	1 (optional)	1 (optional)	1 (optional)
	AT-AR020	AT-AR020	AT-AR020
	AT-AR021S	AT-AR021S	AT-AR021S
	AT-AR023	AT-AR023	AT-AR023
	AT-AR024	AT-AR024	AT-AR024
	AT-AR027	AT-AR027	AT-AR027
	Fixed internal	Fixed internal	Fixed internal
	Indoor	Indoor	Indoor
	0°C to 50°C	0°C to 50°C	0°C to 50°C
	■	■	■
	Async, Telnet	Async, Telnet	Async, Telnet
	v2 and v3	v2 and v3	v2 and v3
	■	■	■
	■	■	■
	■	■	■
	■	■	■
	64	64	64
	■	■	■
	■	■	■
	■	■	■
	■	■	4000 sessions (AT-FL18B) 8000 sessions (AT-FL18C)
	■	■	■
	■	■	■
	■	■	■
	■	■	■
	100	100	100
	■	■	■
	■	■	■
	AT-AR400-ADVLDUPGRD	AT-AR400-ADVLDUPGRD	AT-AR400-ADVLDUPGRD
	■	■	■
	■	■	■
	■	■	■
	■	■	■
	■	■	■
	AT-FL15 (option)	AT-FL15 (option)	AT-FL15 (option)
	AT-AR400-ADVLDUPGRD	AT-AR400-ADVLDUPGRD	AT-AR400-ADVLDUPGRD
	AT-AR400-ADVLDUPGRD	AT-AR400-ADVLDUPGRD	AT-AR400-ADVLDUPGRD
	33.5 x 18 x 4.5cm	33.5 x 18 x 4.5cm	33.5 x 18 x 4.5cm
	13.18 x 7 x 1.77in	13.18 x 7 x 1.77in	13.18 x 7 x 1.77in
	1.96kg / 4.32lbs	1.96kg / 4.32lbs	1.96kg / 4.32lbs
	» Branch office	» Branch office	» Branch office
	» Head office connectivity	» Head office connectivity	» Head office connectivity



Notes



Wireless AP and Routers



Wireless

		ACCESS POINTS AND ROUTERS		BASE STATION	
SUBCATEGORY	FEATURE	AT-WR2304N	AT-TQ2403	AT-WR4561	AT-WR4562
FORM FACTOR		» Wallmountable » Desktop	» Wallmountable » Desktop	» Wallmountable » Pole mount	» Wallmountable » Pole mount
PORTS AND MEDIA SUPPORT	Ethernet	1 x 10/100TX (WAN)	1 x 10/100TX	1 x 10/100TX	1 x 10/100TX
	Serial		1		
	USB	1	1		
	Wireless radio	1 x IEEE 802.11b/g/n (2T2R MIMO : 300Mbps)	2 x IEEE 802.11a/b/g/h	1 x IEEE 802.11a/b/g/h	1 x IEEE 802.11a/b/g/h
POWER SUPPLY	Type	External	External or IEEE 802.3af PoE (PD)	IEEE 802.3af PoE (PD)	IEEE 802.3af PoE (PD)
	Energy Star	■			
ENVIRONMENTAL	Usage	Indoor	Indoor	Outdoor	Outdoor
	Operating temperature range (°C)	0°C to 45°C	0°C to 40°C	-30°C to 65°C	-30°C to 65°C
	UL 579 / IEC ingress protection	IP55	IP55	IP67	IP67
SCALABILITY	Clustering		15 (without wireless VLAN) 8 (with 4 wireless VLANs)		
MANAGEMENT	GUI	■	■	■	■
	CLI		■	■	■
	Login protocol		HTTP, HTTPS, Telnet, SSH	HTTP, HTTPS, Telnet, SSH	HTTP, HTTPS, Telnet, SSH
	SNMP	v1, v2c	v1, v2c	v1, v2c	v1, v2c
	UPnP	■		■	■
NETWORK RESILIENCE				STP, RSTP, LACP, VRRP	STP, RSTP, LACP, VRRP
QoS			■	■	■
SECURITY	RADIUS / IEEE 802.1s / SSL	■		■	■
	Encryption	AES	AES	DES, 3DES, AES	DES, 3DES, AES
	DoS protection	■		■	■
	Firewall	■		■	■
	DMZ	■		■	■
	NAT / NATPT	■		■	■
	ALG	■		■	■
	VPN pass-through	Multiple sessions		■	■
	Filtering	■	■	■	■
	MAC address	■	■	■	■
	IP	■		■	■
	TCP / UDP port	■		■	■
	URL	■		■	■
Peer-to-peer protocol			■	■	
BRIDGING	MAC cloning	■			■
	PPPoE / PPTP / L2TP	■		■	■
	VLAN		■	■	■
	VLAN bridging			■	■
ROUTING	IPv4	■		■	■
	IPv6			■	■
	High-speed MIP				
	OSPF			v2	v2
	RIP			v1, v2	v1, v2
	Multicast support			PIM, IGMP	PIM, IGMP
	Static routing	■		■	■
				■	■
WIRELESS	IEEE 802.11e (QoS)	WMM only	WMM only	■	■
	IEEE 802.11i (security)	■	■	■	■
	MAC ACL	■	■	■	■
	Station isolation	■	■	■	■
	SSID broadcast enabling	■	■	■	■
	WEP (bits)	64, 128	64, 128	64, 128	64, 128
	WPA-EAP, WPA-PSK	■	■	■	■
	WPA2-EAP, WPA2-PSK	■	■	■	■
	Mode: ad-hoc	■	■	■	■
	Mode: infrastructure	■	■	■	■
	Access point	■	■	■	■
	STAtion	■	■	■	■
	Wireless Distribution System (WDS)	■	■	■	■
	Wireless Protected Setup (WPS)	■		■	■
	Wireless Virtual LAN		■	■	■
	Captive portal		■	■	■
	Dynamic channel planning		■	■	■
	Multiple SSID	4	32	128	128
	Regulatory domain compliance		■	■	■
	Rogue AP detection		■	■	■
Antenna	2 x 2.4GHz (2dBi) omni, detachable	2 x 2.4GHz (1.8dBi) / 5GHz (2.8dBi) omni, detachable			
Antenna diversity mode		■			
Wi-Fi certified	■				
DIMENSIONS	(W x D x H)	12.5 x 9.8 x 2.5cm 4.9 x 3.8 x 1in	17.85 x 10.8 x 3cm 7 x 4.3 x 1.2in	21.2 x 5.7 x 18.3cm 8.4 x 2.2 x 7.2in	21.2 x 5.7 x 18.3cm 8.4 x 2.2 x 7.2in
	Weight	.15kg / .3lbs	.23kg / .5lbs	1.2kg / 2.7lbs	1.2kg / 2.7lbs
IDEAL ENVIRONMENT		» Small business (SMB)	» Enterprise	» WISP, enterprise	» WISP, enterprise
CUSTOMER'S NEEDS		» Intranet / Internet access » Indoor wireless bridge	» Intranet access » Indoor wireless bridge » HotSpot access	» WLL » Full HotSpot » Outdoor wireless bridge	» WLL » Full HotSpot » Outdoor wireless bridge



Wireless PoE and NICs



SUBCATEGORY	FEATURE	PSE PoE	PD PoE
		AT-6101G	AT-6102G
FORM FACTOR		» Desktop	» Wallmountable » Desktop
PORTS AND MEDIA	I0/I00/I000T	I	I
POWER SUPPLY	PSU type	Fixed internal	PoE
POWER OVER ETHERNET	IEEE 802.3af	■	■
	PoE enabled ports	I	I
	Max number of full power ports	I	I
	Mode	B	A or B
	PoE power (W)	15.4	10
ENVIRONMENTAL	DC out (V)		5 / 7.5 / 9 / 12
	Cooling	Fanless	Fanless
MANAGEMENT		Unmanaged	Unmanaged
DIMENSIONS	(W x D x H)	11.7 x 6 x 3.6cm 4.6 x 2.4 x 1.4in	8 x 5.6 x 2.6cm 3.1 x 2.2 x 1in
	Weight	.18kg / .4lbs	.08kg / .18lbs
CUSTOMER'S NEEDS		» Feeding protected Power over Ethernet to any Fast and Gigabit Ethernet equipment without having to replace non PoE switches	» Makes any non PoE equipment up to Gigabit Ethernet speed PoE capable » Extract power from a PoE line and supply 5 / 7.5 / 9 or 12vDC to any equipment

Glossary

PoE mode

A: feeding and receiving power on data pairs.
B: feeding and receiving power on spare pairs.

PSE

Power Sourcing Equipment. Feeding power to PD.

PD

Powered Device. Being powered by PSE.



WIRELESS NICs			
SUBCATEGORY	FEATURE	AT-WNP300N	AT-WNU300N
BUS TYPE		PCI 2.2 (full and low-profile bracket)	USB 2.0
PORTS AND MEDIA SUPPORT	Wireless radio	IEEE 802.11b/g/n (1T2R MIMO : 150Mbps)	IEEE 802.11b/g/n (2T2R MIMO : 300Mbps)
ENVIRONMENTAL	Operating temp range (°C)	0°C to 45°C	0°C to 45°C
WIRELESS AND SECURITY	IEEE 802.11e (QoS)	WMM only	WMM only
	IEEE 802.11i (security)	■	■
	IEEE 802.1x supplicant	■	■
	WEP (bits)	64 / 128	64 / 128
	WPA-EAP, WPA-PSK	■	■
	WPA2-EAP, WPA2-PSK	■	■
	Wireless Protected Setup (WPS)	■	■
DIAGNOSTIC LEDS	Dynamic data rate scaling	■	■
	Antenna	2 x 2.4GHz (2dBi) omni, detachable	Embedded
DRIVER SUPPORT	Windows 2000	■	■
	Windows XP	■	■
	Windows Vista	■	■
	Windows 7	Via NDIS wrapper	Via NDIS wrapper
CERTIFIED BY	WHQL	■	■
	Wi-Fi alliance	■	■
DIMENSIONS	(W x D x H)	12 x 6.3cm 4.72 x 2.48in	7.75 x 2.15 x 1.08cm 3.05 x .85 x .43in
	Weight	52g / .11lb	12g / .026lb

Glossary

WMM

Wireless Multimedia.



ANTENNA TYPE	GAIN (dBi)	ALLIED TELESIS TenQ ANTENNA MODEL		LOBE WIDTH (°)		POLARIZATION
		2.4GHz	5GHz	Horizontal	Vertical	
OMNI	2	AT-TQ0500		360	45	V
	5		AT-TQ0500	360	30	V
	8	AT-TQ0201E	AT-TQ0501E	360	17	V
	12	AT-TQ0202E	AT-TQ0502E	360	5	V
PANEL	8	AT-TQ0221E	AT-TQ0521E	75	50	V / H
	15	AT-TQ0222E	AT-TQ0522E	30	30	V / H
	20	AT-TQ0223E	AT-TQ0523E	15	15	V / H
SECTOR	12	AT-TQ0241E	AT-TQ0541E	120	15	V
	14	AT-TQ0242E	AT-TQ0542E	60	15	V
	18	AT-TQ0243E		30	15	V
	19	AT-TQ0261E		15	15	V
PARABOLIC	23		AT-TQ0561E	7.5	7.5	V
	24	AT-TQ0262E		8	8	V
	27.5		AT-TQ0562E	5.2	5.2	V

Glossary

Polarization

Defines the position into space of electrical and magnetic field. The best signal transfer happens when both transmitting and receiving antennas have the same polarization. A 90° difference in polarization between transmitting and receiving antenna may produce up to -30dB of signal attenuation.

- V
- H
- V/H

Vertical.
Horizontal.
V or H depending on mounting.

Antenna Type

- Omni
- Panel

Omnidirectional antennas radiate power uniformly in every direction on the horizontal plane. Mainly used for mobile user's access.
Is a flat antenna whose radiation lobe is similar to a cone. It's directional and is normally used to point-to-point links or at the end-points of a point-to-multipoint network.

- Sector

Is a flat antenna whose radiation lobe is similar to a cone with an elliptical footprint. It's directional and is normally used in the central site of a point-to-multipoint network.

- Parabolic

Is a dish shaped directional antenna, whose radiation lobe is similar to that of a Panel antenna. It's usually larger than a Panel and has a higher gain. It's suitable for long distance point-to-point links.



Notes



Wireless Accessories



Wireless

SUBCATEGORY	FEATURE	WALL-MOUNT	COAX CABLES			
		AT-WR4501	AT-TQ0001	AT-TQ0003	AT-TQ0041	AT-TQ0045
ENVIRONMENTAL	In/outdoor usage	Outdoor	Outdoor	Outdoor	Outdoor	Outdoor
ANTENNA / CABLE TYPE			HDF200	HDF200	HDF400	HDF400
ANTENNA GAIN (dBi)	@ 2.4GHz					
	@ 5GHz					
INSERTION LOSS (dB)	@ 2.4GHz		-0.5	-1.7	-0.3	-1.2
	@ 5GHz		-0.7	-2.7	-0.5	-2.1
CONNECTOR			1 x N plug 1 x RP-SMA plug	1 x N plug 1 x RP-SMA plug	2 x N plug	2 x N plug
COMPATIBLE EQUIPMENT	AT-WR4541a / AT-WR4541g				■	■
	AT-WR4542					
	AT-WR4561 / AT-WR4562	■			■	■
	AT-TQ2403		■	■		
DIMENSIONS	(W x D x H) / Length	18.9 x 8.9 x 3.7cm 7.4 x 3.5 x 1.5in	.5m 1ft 7.7in	3m 9ft 10in	.5m 1ft 7.7in	5m 16ft 4.9in
	Weight	.48kg / 1.06lbs	.10kg / .22lbs	.20kg / .44lbs	.12kg / .26lbs	.6kg / 1.32lbs
IDEAL ENVIRONMENT		» WISP, enterprise	» WISP, enterprise	» WISP, enterprise	» WISP, enterprise	» WISP, enterprise
CUSTOMER'S NEEDS		» Wall-mount	» Higher gain or directional antenna	» Higher gain or directional antenna	» External antenna	» External antenna

Glossary

Gain

The only reason for designing and using special antennas is to modify the 'radiation pattern'. In fact, an antenna works as a lens or a parabolic reflector concentrating the radiated power into a narrow beam and enhancing the received signals like a telescope. Therefore, the Gain expresses how much the antenna enhances the transmitted and received signals relative to simple radiators like a dipole or a dot shaped one, called 'isotropic'. In the first case the antenna gain is expressed in dBd (decibels over dipole) while in the latter it is expressed in dBi (decibels over isotropic).

Since a dipole's gain is 2.15 dBi and dB are logarithmic quantities, the antenna gain in dBi is equal to the gain in dBd plus 2.15.

Loss

WISP

The attenuation of the cable or device. In dB.

Wireless Internet Service Provider.

Using high gain antennas is not always a good idea!

Antennas have on electromagnetic waves the same effect that lenses have on light.

A high gain antenna does not increase the radiated power but simply concentrates the power fed by the transmitter in a certain area and 'magnifies' the received signal from the same area. Therefore choosing the right antenna is very important and largely affects the performances of every wireless network.

The various antenna types differ from each other in their footprint shape. Increasing the gain has the effect of reducing their footprint size.

An Omni-directional antenna concentrates the signal in a 360° belt around it. The higher the gain the thinner the belt is. The result is a better signal far from the antenna and a signal so low below the antenna that it can be impossible to communicate.

Panel and Parabolic antennas have a nearly circular footprint. Low gain panels can be used for both short distance point-to-point and point-to-multipoint links but can be successfully used for straight roads coverage too. High gain Panel and Parabolic antennas produce such a small spot that can be deployed only in medium to long distance point-to-point links.

A Sector antenna footprint is a horizontal ellipse whose width is usually 30°, 60°, 90° or 120°, therefore higher gain sector antennas have a vertically thinner footprint while keeping the same horizontal width. This allows for using Sector antennas in the central site of a point-to-multipoint link or for coverage of a certain 'sector' in mobile networks.

Choosing the right antenna is like choosing the best lighting system between various types of streetlamps and lighthouses. You will never choose the latter for lighting a yard.



CAT5 CABLES		ANTENNA	RF SPLITTERS		SURGE PROTECTOR
AT-TQ0051	AT-TQ0053	AT-TQ0500	AT-TQ0292	AT-TQ0592	AT-TQ0591
Outdoor	Outdoor	Outdoor	Outdoor	Outdoor	Outdoor
CAT5 UTP	CAT5 UTP	Omni			
		2			
		5			
			-0.6	-0.5	-1.5
				-0.5	-1.5
1 x RJ-45 plug 1 x waterproof RJ-45 plug	1 x RJ-45 plug 1 x waterproof RJ-45 plug	1 x N plug	3 x N socket	3 x N socket	1 x N plug 1 x N socket
■	■	■	■	■	■
■	■	■	■	■	■
■	■	■	■	■	■
10m 32ft 9.6in	30m 98ft 5.1in	2.2 x 2.2 x 19cm .9 x .9 x 7.5in	7.7 x 5.5 x 4.2cm 3 x 2.2 x 1.7in	8 x 3 x 8cm 3.1 x 1.2 x 3.1in	6.5 x 3.4 x 2.5cm 2.6 x 1.3 x 1in
.5kg / 1.10lbs	1.5kg / 3.31lbs	.07kg / .15lbs	.33kg / .72lbs	.33kg / .72lbs	.14kg / .31lbs
» WISP, enterprise	» WISP, enterprise	» WISP, enterprise	» WISP, enterprise	» WISP, enterprise	» WISP, enterprise
» Achieve IP67 protection level for AT-WR4500 equipments		» HotSpot » AP	» Two antennas on one radio I/F	» Two antennas on one radio I/F	» Equipment lightning protection

Omni Antenna Radiation Lobes

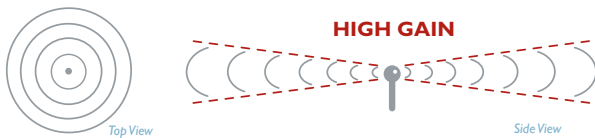
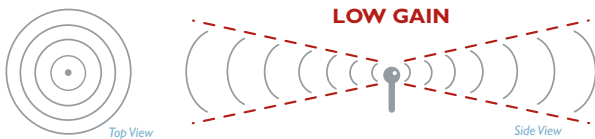

Panel and Sector Antenna Radiation Lobes



Notes



iMAP Chassis



		iMAP CHASSIS		
SUBCAT	FEATURE	MiniMAP 9100	iMAP 9400 Series	
MODEL NUMBER		AT-TN-9101 / 2 / 3	AT-TN-251G	
PHYSICAL HEIGHT		1RU	3RU	
POWER SUPPLY	Single AC	AT-TN-9102	Requires additional AT-TN-R111	
	Dual AC (option)	AT-TN-9103	Requires additional AT-TN-R111 and AT-TN-R112	
	Dual DC	AT-TN-9101	Standard	
CONTROLLER CARDS	Primary fabric controller	CFC12 (AT-TN-408)	CFC24 (AT-TN-401)	CFC56 (AT-TN-407)
	Optional redundant controller			
NETWORK TRANSPORT	Slots	None - transport on CFC12 fabric	2	2
	Model	CFC12 fabric (AT-TN-408)	GE3 (AT-TN-301)	XE1 (AT-TN-308)
	Uplink ports	4 x SFP + 2 x 10/100/1000T	3 x SFP	1 x XFP
	Uplink speed	Gigabit	Gigabit	10GbE
BLADE SLOTS		3	7	
MAX PORTS	xDSL	72	168	
	POTS	72	168	
	T1/E1	24	56	
	Dual fiber (100Mbps)	30	70	
	BiDi single fiber (100Mbps)	60	140	
	10/100TX (copper)	30	70	
	Gigabit	24	56	
	GEAPON	192	448	
TEMPERATURE RANGE (°C)		-40°C to 65°C (AT-TN-9102/3 AC version = 0°C to 55°C)	-40°C to 65°C	
DIMENSIONS	(W x D x H)	(AT-TN-9101) DC power 48.3 x 30 x 4.45cm 19 x 11.8 x 1.75in	48.3 x 30 x 13.3cm 19 x 11.8 x 5.25in	
		(AT-TN-9102/3) AC power 48.3 x 51.3 x 4.45cm 19 x 20.2 x 1.75in		
	Weight	4kg / 8.8lbs (DC chassis) 6.7kg / 14.75lbs (AC chassis)	7kg / 15.4lbs	

As the world's communications systems move to an all IP and Ethernet access network with IP/MPLS core, Allied Telesis' iMAP integrated Multiservice Access Platform represents the first and only true IP access platform designed for this purpose. Its unique carrier-grade IP/Ethernet capabilities are suitable for any provider building an IP access network now. Founded on the premise that IP/Ethernet solutions are the basis of any viable next generation service network, it provides industry leading capabilities that position the iMAP as the access network for alternative and emerging carriers, Independent Operating Companies (IOCs), PTTs, ILECs, ISPs, public utilities and private organizations such as hospitals, hotels and Multi-Tenant/ Multi-Dwelling Units (MTU/MTD).

One Access Platform, Any Service

The iMAP product family was designed from the outset to support IP Triple Play and IP video services using Ethernet technology. With redundant Gigabit Ethernet connections to each line card from the control modules, there is ample bandwidth and throughput for all current and future services and access technologies. A common control and fabric enables 10GbE backplane connectivity, ensuring future capacity and performance needs are addressed without ever requiring a forklift upgrade.



iMAP CHASSIS						
iMAP 9700 Series			iMAP 9810			
AT-TN-250G			AT-TN-253G			
9RU			3RU			
Requires additional AT-TN-R113			Requires additional AT-TN-R113			
Requires additional AT-TN-R113 and AT-TN-R114			Requires additional AT-TN-R113 and AT-TN-R114			
Standard			Standard			
CFC24 (AT-TN-401)	CFC56 (AT-TN-407)	CFC56 (AT-TN-407)	CFC100 (AT-TN-409)	CFC100 (AT-TN-409)	CFC100 (AT-TN-409)	CFC100 (AT-TN-409)
CFC24 (AT-TN-401)	CFC56 (AT-TN-407)	CFC56 (AT-TN-407)	CFC100 (AT-TN-409)	CFC100 (AT-TN-409)	CFC100 (AT-TN-409)	CFC100 (AT-TN-409)
2	2	2	2	2	2	2
GE3 (AT-TN-301)	XE1 (AT-TN-308)	XE6 (AT-TN-309)	GE3 (AT-TN-301)	XE1 (AT-TN-308)	XE6 (AT-TN-309)	XE6 (AT-TN-309)
3 x SFP	1 x XFP	6 x SFP+	3 x SFP	1 x XFP	6 x SFP+	6 x SFP+
Gigabit	10GbE	10GbE	Gigabit	10GbE	10GbE	10GbE
17 (16 with dual-fabric cards)		15 (when dual XE6 installed) (14 with dual-fabric cards)	8		6 (when dual XE6 installed)	
408		360	192		144	
408		360	192		144	
136		120	64		48	
170		150	80		60	
340		300	160		120	
170		150	80		60	
136		120	64		48	
1088		960	512		384	
-40°C to 65°C			-40°C to 65°C			
48.3 x 30 x 40cm 119 x 11.8 x 15.75in			48.3 x 30.5 x 13.3cm 19 x 12 x 5.25in			
15kg / 33lbs			7kg / 15.4lbs			

Multiple Services, Diversified and Increased Revenues

The flexible design architecture allows you to deliver multiple services. In addition to the traditional and enhanced ADSL/ADSL2+ and VDSL2, the iMAP empowers operators with the capability to offer revenue-generating residential and business services such as FTTx, T1/E1, G.SHDSL and POTS – all from the same platform. With features like Ethernet Protection Switched Rings (EPSR), the iMAPs can be networked together using ring topology with full redundancy and sub-50ms switchover times, ensuring carrier-grade five nines (99.999%) availability and maximum service uptime whilst reducing the need for additional transport expenses.



Notes



iMAP Blades



iMAP BLADES

SUBCAT	FEATURE	FE10	POTS24	ADSL24A	ADSL24AE	PAC24	PAC24EU	ADSL24SA	ADSL48A
PART NUMBER		AT-TN-102	AT-TN-113	AT-TN-121	AT-TN-140	AT-TN-123	AT-TN-136	AT-TN-129	AT-TN-131
COPPER	10/100TX	10							
	POTS		24			24	24		
	ADSL splitter							24	
	ADSL (Annex A)			24	24	24	24	24	48
	ADSL (Annex B)								
	G.SHDSL								
	VDSL2 (Annex A)								
	VDSL2 (Annex B)								
T1/E1 (circuit emulation)									
T1/E1 (data transport)									
FIBER	100Mbps (2 fiber), SMF								
	100Mbps BiDi, SMF								
	SFP (1000Mbps)								
	GEAPON								
PHYSICAL	Single / double width blade	Single	Single	Single	Single	Double	Double	Double	Double
SALES TERRITORY			US only			US only	EU only	US only	

iMAP Controller Cards



iMAP CONTROLLER CARDS

SUBCAT	FEATURE	CFC12	CFC24	CFC56	CFC100
PART NUMBER		AT-TN-408	AT-TN-401	AT-TN-407	AT-TN-409
CHASSIS COMPATIBLE	MiniMAP9100	■			
	iMAP 9400 series		■	■	
	iMAP 9700 series		■	■	
	iMAP 9810				■
PERFORMANCE	Switching fabric	12Gbps	24Gbps	56Gbps	100Gbps
	EPSR	■	■	■	■
	VLANs per port	4095	4095	4095	4095
	Per VLAN rate limiting	■	■	■	■
UPLINKS	SFP (1000Mbps)	4			
	10/100/1000T	2			
SECURITY	Upstream forwarding only	■	■	■	■
	ACL support	■	■	■	■
QoS	Priority queues	8	8	8	8
	Priority scheduling	■	■	■	■

Video-optimized

The iMAP has been optimized for video deployments with several video specific features, such as fast joins and leaves for IGMP multicasting.

Carrier-grade Design

Hot swappable modules, redundancy throughout the system elements (power; network uplinks, control modules, backplane connectivity), and hitless software upgrades ensure maximized system and network uptime. NEBS compliant.





iMAP BLADES

	ADSL24B	ADSL48B	SHDSL24	VDSL24A	VDSL24B	CES8	NTE8	FX10LX	FX10BX	FX20BX	FX20BX40	GE8	GEPON
	AT-TN-124	AT-TN-132	AT-TN-127	AT-TN-130	AT-TN-128	AT-TN-119	AT-TN-125	AT-TN-107	AT-TN-109	AT-TN-139	AT-TN-142	AT-TN-117	AT-TN-118
	24	48											
			24										
				24									
					24								
						8							
							8						
								10					
									10 (15km)	20 (15km)	20 (40km)		
												8	
													2
	Single EU only	Double EU only	Single	Single	Single	Single	Single	Single	Single	Single	Single	Single	Single

FTTx: Supporting Latest Fiber Technologies

The iMAP platform supports the migration from copper towards fiber in the access network where fiber is deployed to the most economical point in the access network. The iMAP family supports active point-to-point Ethernet and passive Gigabit EPON technologies providing operators and service providers with full flexibility for deploying the most appropriate technology for their requirements and needs.

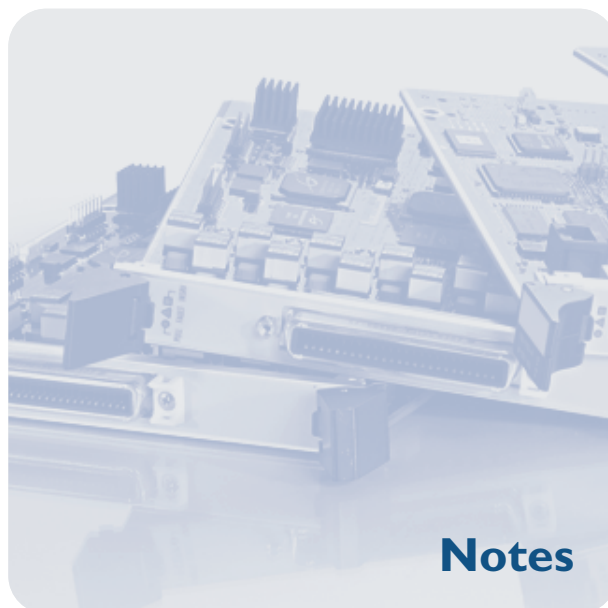

Notes



INTELLIGENT MULTISERVICE GATEWAYS

SUBCATEGORY	FEATURE	iMG624 Series	iMG634 Series	iMG634W Series	AT-iMG801	AT-iMG804	AT-iMG804W
ENVIRONMENTAL	Indoor usage	■	■	■	■	■	■
	Outdoor usage						
UPLINK	ADSL2+ Annex A	AT-iMG624A-R2	AT-iMG634A-R2	AT-iMG634WA-R2			
	ADSL2+ Annex B		AT-iMG634B-R2	AT-iMG634WB-R2			
	VDSL2 17a profile				■	■	■
	ADSL2+ fallback				■	■	■
	Ethernet 100Mbps copper	■	■	■			
	Ethernet 100Mbps fiber (MMF)						
	Ethernet 100Mbps fiber (SMF)						
	Ethernet 100Mbps fiber (BiDi)						
	Ethernet 100Mbps fiber (40km BiDi)						
	Ethernet 100Mbps fiber SFP module						
Ethernet 1000Mbps fiber (BiDi)							
GEAPON							
LAN INTERFACE	10/100TX	4	4	4	1	4	4
	10/100/1000T						
	Wireless IEEE 802.11b/g			■			■
	HPNA						
	HPNAv3.1						
TI/EI CES							
WAN PORT	Copper / fiber	Copper	Copper	Copper	Copper	Copper	Copper
CATV RF OVERLAY	Low output power						
	High output power						
PHONE INTERFACES	FXS		2	2			
	PSTN lifeline		■	■			
VoIP PROTOCOLS	SIP / MGCP		■	■			
CONSOLE INTERFACE	RS232 RJ-45 connector	■	■	■			
	8 position min DIN connector						
QoS	IEEE 802.1p priority queues	■	■	■			
	IEEE 802.1Q VLANs management	■	■	■			
MANAGEMENT	AlliedView NMS	■	■	■			
	SNMPv1, v2 and v3	■	■	■	■	■	■
	Telnet, Web, GUI, CLI	■	■	■	■	■	■
	Remote software upgrade	■	■	■			
ACCESSORY AVAILABLE	Fiber outlet kit AT-iMG001			■			
	Battery backup AT-iMG008G		■	■			
	Outdoor case AT-EN646MOD						

The Allied Telesis iMG (iMG600 series) and iBG (iBG900 series) gateway families provide a wide range of CPE (Customer Premise Equipment) covering different uplink technology, LAN configuration and environmental conditions. The iMG and iBG families provide multiple IP-based broadband services over a high-speed, always-on broadband connection. The combined delivery of IP Triple Play services - voice, video and data - benefits both service providers and their customers.

iMG (intelligent Multiservice Gateway)

The iMG family provide multiple IP-based broadband services to the home over either a twisted pair or fiber, always-on broadband connection. The wide range of WAN interface options provided by this family allows service providers to easily migrate and adapt their existing cabling infrastructure to supply customers with the latest IP-based services.

iBG (intelligent Business Gateway)

The iBG family is targeted at small to medium enterprise applications requiring more ports than on the iMG family, extending the application to customers requiring up to eight LAN and eight telephone connections.



Network Management & Software

AlliedView EMS™ Network Device Management Software

The AlliedView EMS is a comprehensive network management platform designed to offer smaller and medium sized enterprise customers powerful tools for the management of their Allied Telesis products. With a full suite of provisioning and monitoring tools, the AlliedView EMS maximizes the operational efficiency by providing proactive diagnostics, reducing operational expense and hence shortening the path to profitable revenue.

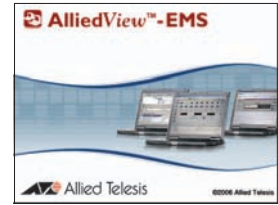

Low-cost Deployment

AlliedView EMS, although based on AlliedView NMS, has been designed to operate on a Windows based machine running XP or Server 2003/8. With a tiered approach to licencing, users can deploy AlliedView EMS on even the smallest size networks, in a cost effective manner.

Network Inventory

The AlliedView EMS provides automatic topology and device discovery of networks. The EMS allows for multiple network and device views where the user can observe the entire network or focus in on an individual network device. In addition, the EMS contains inventory of different device types and enables views of VLANs, network interfaces, ports, and physical links.

Flexible Configuration

The extensive management capabilities of AlliedView EMS allows the user to manage hundreds of Allied Telesis network elements, and configure them from a central location. Products can be easily configured for both Layer 2 and Layer 3 functionality, as well as VLANs, and resilient EPSR and LACP trunks.

Network Upgrades

The AlliedView EMS can perform scheduled or unscheduled network wide firmware and software upgrades to many of the Allied Telesis device types. AlliedView EMS maintains control of software releases to ensure all nodes in the network always maintain consistent software loads.

Features

- Intuitive graphical interface
- Drill-down functionality
- MIB browser
- MIB compiler
- GUI snapshot utility
- RMON 4 group support
- Supports NMS alarms
- Supports SNMP v1, v2c and v3
- VLAN management
- QoS management
- Windows XP and Windows Server 2003/8 support
- Supports Allied Telesis managed devices

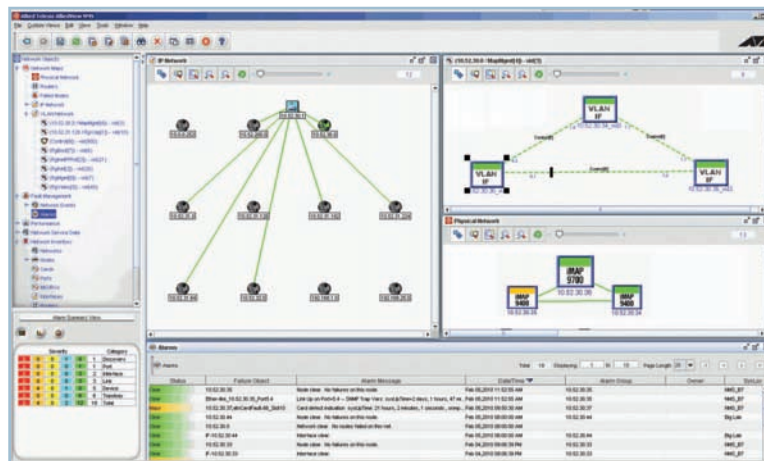



AlliedView NMS™ Network Management Software

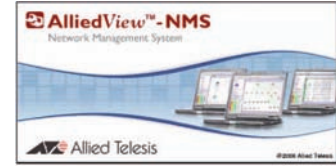

The AlliedView NMS is a comprehensive network management platform designed to offer network service providers and larger enterprise customers powerful tools for the management of their Allied Telesis products and provisioning of multiple services in the IP and Ethernet based access network. With a full suite of provisioning and monitoring tools, the AlliedView NMS maximizes the operational efficiency by providing proactive diagnostics, minimizing service deployment times, reducing operational expense and hence shortening the path to profitable revenue.

Flexible Management Tools

With extensive management capabilities, the AlliedView NMS allows the user to manage thousands of Allied Telesis network elements from a remote operations center - thus reducing the need for a truck roll to perform diagnostics or make provisioning changes. Via a user-friendly Graphical User Interface (GUI), the NMS will substantially decrease the time required for deploying and provisioning large networks. Among the key strengths of the NMS is network monitoring and network wide service provisioning.

Scalable Architecture

The three essential constituents of AlliedView NMS architecture are Back-End (BE) server, Front-End (FE) server and the user client.

The Back-End server (BE) performs core, server-side network facing tasks, such as the discovery, alarm notifications, data collection, report generation, status polling and northbound interface.

The Front-End server (FE) provides scalability in terms of the number of clients that can be supported. High availability of the client can be achieved by increasing the number of FEs connected to BE. AlliedView NMS is designed to run in mission critical environments which require continuous and uninterrupted access to the NMS. If a failure occurs of the primary BE server an automatic switch takes place to a redundant or warm standby server. In the switch over process all the functions being performed by the primary server are automatically assumed by the redundant server ensuring an uninterrupted access to NMS functions. Failover makes the NMS systems fault-tolerant. The process of switching over has been designed to be smooth and automatic so that the end-user does not notice the failure of the primary server or the subsequent switch to the standby. Failover support is provided for both BE and FE servers.

Network Inventory

The AlliedView NMS provides automatic topology and device discovery of networks, regardless of size. The NMS allows for multiple network and device views where the user can observe the entire network or focus in on an individual network device. In addition, the NMS contains inventory of different device types and enables views of VLANs, network interfaces, ports, and physical links.

Zero Touch Service Provisioning

The AlliedView NMS allows for the rapid deployment of multiple services (e.g. Internet access, IPTV video and VoIP telephony) via the provisioning of VLANs and QoS policies across multiple devices using a Graphical User Interface (GUI). Provisioning and rollout of new services and devices are significantly accelerated via the use of profiles for the most common types of services in the network. By defining a common set of profiles NMS enables multiple services to a subscriber to be provisioned via a single screen.

Network Upgrades

The AlliedView NMS can perform scheduled or unscheduled network wide firmware and software upgrades to many of the Allied Telesis device types. The NMS maintains control of software releases to ensure all nodes in the network always maintain consistent software loads.

Northbound Interface

AlliedView NMS can interoperate with existing Operation Support Systems (OSS) and Business Support Systems (BSS) through northbound protocols, such as SNMP and XML/SOAP. The current northbound interface is read only and supports Apache/AXIS with an XML-based API.

Features

- Intuitive graphical interface
- Drill-down functionality
- MIB browser
- MIB compiler
- GUI snapshot utility
- RMON 4 group support
- Supports NMS alarms
- Supports SNMP v1, v2c and v3
- VLAN management
- QoS management
- Multi-platform
- HP OpenView, Tivoli NetView, Ipswitch WhatsUp and SNMPc interoperability
- Supports Allied Telesis managed devices



Our Locations

Worldwide Headquarters

Japan - Headquarters

Allied Telesis Holdings K.K.
2nd. TOC Bldg.
7-21-11 Nishi-Gotanda
Shinagawa-ku, Tokyo 141-0031
Tel: +81 3 5437 6000

United States & Latin America - Headquarters

Allied Telesis Inc.
19800 North Creek Parkway, Suite 100
Bothell, WA 98011
Tel: +1 425 487 8880
Fax: +1 425 489 9191

Europe - Headquarters

Allied Telesis International SA
Via Motta 24
6830 Chiasso
Switzerland
Tel: +41 91 69769.00
Fax: +41 91 69769.11

Asia Pacific - Headquarters

Allied Telesis Asia Pacific Pte Ltd.
11 Tai Seng Link
Singapore 534182
Tel: +65 6383 3832
Fax: +65 6383 3830
E-mail: sales-asia@alliedtelesis.com.sg

Please refer to our website on www.alliedtelesis.com for all other Allied Telesis locations.

Disclaimer

Allied Telesis continuously enhances its products. As a result, this catalog may not correctly represent all products currently available. Products may also vary by geographic region. Product specifications can change without notice, and while Allied Telesis makes every effort to ensure the accuracy of information presented in this catalog, we do not accept liability for errors or changes in the stated specifications. For current product availability in your region, full and complete product specifications and warranty information, please contact your regional sales manager or visit us online at www.alliedtelesis.com.



Allied Telesis RoHS-compliant product conforms to the European Union Restriction of the Use of Certain Hazardous Substances (RoHS) in Electrical and Electronic Equipment. Allied Telesis ensures RoHS conformance by requiring supplier Declarations of Conformity, monitoring incoming materials, and maintaining manufacturing process controls.

Product A-Z

Product A-Z

» Index							
Product	#	Product	#	Product	#	Product	#
AlliedView EMS	52	AT-DINRAIL	28	AT-MC13	26	AT-TN-9101 (MiniMAP 9100)	46
AlliedView NMS	53	AT-FS201	27	AT-MCF2000	29	AT-TN-9102 (MiniMAP 9100)	46
AT-2451FTX	32	AT-FS202	27	AT-MCF2012LC	29	AT-TN-9103 (MiniMAP 9100)	46
AT-2701FTX	32	AT-FS232	27	AT-MCF2012LC/1	29	AT-TQ0001	44
AT-2701FX	35	AT-FS232/1	27	AT-MCF2032SP	29	AT-TQ0003	44
AT-2701LX20	35	AT-FS232/2	27	AT-MCF2300	29	AT-TQ0041	44
AT-2711FX	35	AT-FS238A/1	27	AT-MCPWR	28	AT-TQ0045	44
AT-2712FX	35	AT-FS238B/1	27	AT-MCRI	28	AT-TQ0051	45
AT-2712LX20	35	AT-FS705EFC	8	AT-MCRI2	28	AT-TQ0053	45
AT-2716FX/TP	32	AT-FS705L	8	AT-PC2002POE	26	AT-TQ0292	45
AT-2746FX	35	AT-FS705LE	8	AT-PC232/POE	27	AT-TQ0500	45
AT-2801FX	36	AT-FS708	9	AT-SBx908	19, 21, 22	AT-TQ0591	45
AT-2812FX	36	AT-FS708LE	8	AT-SP10ER40/1	25	AT-TQ0592	45
AT-2872SX	36	AT-FS708/POE	9, 12	AT-SP10LR	25	AT-TQ2403	40
AT-2912T	32	AT-FS709FC	9	AT-SP10LR/1	25	AT-Tray1	28
AT-2916LX10	34	AT-FS716L	9	AT-SP10LR20/1	25	AT-Tray4	28
AT-2916SX	34	AT-FS717FC	9	AT-SP10SR	25	AT-WLMT	28
AT-2931SX	34	AT-FS724L	9	AT-SP10TW	25	AT-WNP300N	42
AT-2972LX10	34	AT-FS750/16	10	AT-SPEX	24	AT-WNU300N	42
AT-2972SX	34	AT-FS750/24	10	AT-SPBD10-13	25	AT-WR2304N	40
AT-2973SX	37	AT-FS750/24POE	10, 12	AT-SPBD10-14	25	AT-WR4501	44
AT-2973T	37	AT-FS750/48	10	AT-SPFX/15	24	AT-WR4541a	41
AT-2973T/4	37	AT-G8LX10	25	AT-SPFX/2	24	AT-WR4541g	41
AT-6101G	42	AT-G8SX	24	AT-SPFXBD-LC-13	24	AT-WR4561	40
AT-6102G	42	AT-G8T	24	AT-SPFXBD-LC-15	24	AT-WR4562	40
AT-8000/8POE	12, 14	AT-GS2002/SP	26	AT-SPLX10	24	AT-WR4652	41
AT-8000GS/24	16	AT-GS900/5E	8	AT-SPLX10/1	25	AT-WR4662	41
AT-8000GS/24POE	13, 16	AT-GS900/8	8	AT-SPLX40	25	AT-x600-24Ts	17, 18
AT-8000GS/48	16	AT-GS900/8E	8	AT-SPSX	24	AT-x600-24Ts-POE	13, 17, 18
AT-8000S/16	14	AT-GS900/16	8	AT-SPSX/1	24	AT-x600-24Ts/XP	17, 18, 20
AT-8000S/24	14	AT-GS900/24	9	AT-SPTX	24	AT-x600-48Ts	17, 18
AT-8000S/24POE	13, 14	AT-GS950/8	11	AT-SPZX	25	AT-x600-48Ts/XP	17, 19, 20
AT-8000S/48	14	AT-GS950/8POE	11, 12	AT-TN-102 (FE10)	48	AT-x900-12XT/S	19, 20
AT-8000S/48POE	13, 15	AT-GS950/16	11	AT-TN-107 (FX10LX)	49	AT-x900-24XS	19, 21
AT-8516F/SC	15	AT-GS950/24	11	AT-TN-109 (FX10BX)	49	AT-x900-24XT	19, 20
AT-8624POE	13, 15	AT-GS950/48	11	AT-TN-113 (POTS24)	48	AT-x900-48FE	15
AT-8624T/2M	15	AT-iBG915FX	51	AT-TN-117 (GE8)	49	AT-x900-48FS	15
AT-8648T/2SP	15	AT-iMG606BD	51	AT-TN-118 (GEPON)	49	AT-XEM-12S	21, 22
AT-9000/28	16	AT-iMG616xx	51	AT-TN-119 (CES8)	49	AT-XEM-12T	21, 22
AT-9000/28SP	16	AT-iMG616RF	51	AT-TN-121 (ADSL24A)	48	AT-XEM-1XP	21
AT-9000/52	16	AT-iMG616W	51	AT-TN-123 (PAC24)	48	AT-XEM-2XP	21, 22
AT-9408LC	16	AT-iMG624x	50	AT-TN-124 (ADSL24B)	49	AT-XEM-STK	21, 22
AT-9424T	17	AT-iMG634x	50	AT-TN-125 (NTE8)	49	AT-XPER40	21, 25
AT-9424T/POE	13, 17	AT-iMG634Wx	50	AT-TN-127 (SHDSL24)	49	AT-XPER80	21, 25
AT-9924SP	17	AT-iMG646BD	51	AT-TN-128 (VDSL24B)	49	AT-XPLR	21, 25
AT-9924T	17	AT-iMG726MOD	51	AT-TN-129 (ADSL24SA)	48	AT-XPSR	21, 25
AT-AR415S	38	AT-iMG746MOD	51	AT-TN-130 (VDSL24A)	49	iMAP 9400	46
AT-AR440S	38	AT-iMG801	50	AT-TN-131 (ADSL48A)	48	iMAP 9700	46
AT-AR441S	38	AT-iMG804	50	AT-TN-132 (ADSL48B)	49	iMAP 9810	47
AT-AR442S	38	AT-iMG804W	50	AT-TN-136 (PAC24EU)	48	MiniMAP 9100	46
AT-AR750S	38	AT-MC1004	26	AT-TN-139 (FX20BX)	49	SwitchBlade x908	19, 21, 22
AT-AR770S	38	AT-MC1008/GB	26	AT-TN-140 (ADSL24AE)	48		
AT-CM301	30	AT-MC1008/SP	26	AT-TN-142 (FX20BX40)	49		
AT-CM302	30	AT-MC101XL	26	AT-TN-250G (iMAP 9700)	47		
AT-CM70S	30	AT-MC102XL	26	AT-TN-251G (iMAP 9400)	46		
AT-CMK0S	30	AT-MC103LH	26	AT-TN-253G (iMAP 9810)	47		
AT-CV1000	30	AT-MC103XL	26	AT-TN-401 (CFC24)	48		
AT-CV1203	30	AT-MC104XL	26	AT-TN-407 (CFC56)	48		
AT-CV5001	30	AT-MC115XL	26	AT-TN-408 (CFC12)	48		
AT-CV1KSS	30	AT-MC116XL	27	AT-TN-409 (CFC100)	48		



INSERT COMPANY DETAILS

USA Headquarters | 19800 North Creek Parkway | Suite 100 | Bothell | WA 98011 | USA | T: +1 800 424 4284 | F: +1 425 481 3895

European Headquarters | Via Motta 24 | 6830 Chiasso | Switzerland | T: +41 91 69769.00 | F: +41 91 69769.11

Asia-Pacific Headquarters | 11 Tai Seng Link | Singapore | 534182 | T: +65 6383 3832 | F: +65 6383 3830

www.alliedtelesis.com

© 2010 Allied Telesis Inc. All rights reserved. Information in this document is subject to change without notice. All company names, logos, and product designs that are trademarks or registered trademarks are the property of their respective owners.

617-000325 Rev.A